

December 2013



# HAMMOND REEF GOLD PROJECT Conceptual Closure and Rehabilitation Plan

VERSION 2

**Submitted to:**

Osisko Hammond Reef Gold Ltd.  
155 University Avenue, Suite 1440  
Toronto, Ontario M5H 3B7

**Project Number:** 13-1118-0010

**Document Number:** DOC026

**Distribution:**

Alexandra Drapack, Director Sustainable Development  
Cathryn Moffett, Project Manager Sustainable Development





## **TABLE OF CONTENTS**

**Part A: Introduction**

**Part B: Supplemental Information Package**

**Part C: Conceptual Closure and Rehabilitation Plan, Version 1**



*Page left intentionally blank*

# **PART A**

## **Introduction**





Version 1 of the Conceptual Closure and Rehabilitation Plan Technical Supporting Document (TSD) was published on February 15, 2013 as part of Osisko Hammond Reef Gold's (OHRG) Draft Environmental Impact Statement/Environmental Assessment (EIS/EA) Report.

The Draft EIS/EA Report underwent a seven-week public review comment period after which, on April 5, 2013, OHRG received comments from the public, Aboriginal groups and the Government Review Team (GRT) seeking clarification and requesting new information.

Approximately 40 comments regarding the Conceptual Closure and Rehabilitation Plan TSD and component of the EIS/EA Report were received from the GRT. Written responses were prepared for each comment and are provided in Appendix 1.IV of the EIS/EA Report.

Version 1 of the Conceptual Closure and Rehabilitation Plan TSD has not been revised. The proposed closure plan is technically defensible and is based on standard industry practices and successful closure activities carried out at other mines in the region.

The EIS/EA Report has been revised and updated based on comments received. Version 2 of the Conceptual Closure and Rehabilitation Plan TSD is comprised of the following:

- Part A: Introduction
- Part B: Supplemental Information Package (attached) that provides additional detail on new work undertaken related to the Conceptual Closure and Rehabilitation Plan component and the Conceptual Closure and Rehabilitation Plan TSD.
- Part C: Version 1 of the Conceptual Closure and Rehabilitation Plan TSD. Part C was issued in February 2013, and is available online on OHRG's website; it has not been re-printed as part of this Version 2 of the Conceptual Closure and Rehabilitation Plan TSD. The Version 1 document should be reviewed within the context of this Version 2 document, and associated updated information as presented in Part A or Part B should be considered as correct should it differ from the information presented in Version 1.

A summary of the information found in Part B is provided below. Throughout the EIS/EA Report, unless otherwise noted, all references made to the Conceptual Closure and Rehabilitation Plan TSD are to Part C.

### **Closure Alternatives**

A number of Information Requests (IRs) from the GRT noted that the Conceptual Closure and Rehabilitation Plan TSD describes a single preferred method of closure and rehabilitation for each element of the mine closure; it does not describe the closure alternatives that were considered. This observation was correct; the conceptual closure plan document did not provide descriptions of the closure alternatives that were considered. The document was based on a formal closure plan that was prepared in draft form for eventual certification and submittal to the Ministry of Northern Development and Mines (MNDM). The formal closure plan was required to follow a format which is dictated by Schedule 2 to O. Reg. 240/00 under the Mining Act. Schedule 2 requires detailed descriptions of the selected closure methods; however it does not require a discussion of alternative methods that were considered but not ultimately selected.

In the preparation of the conceptual closure plan (and also the formal closure plan), due consideration was given to possible alternative approaches that could be taken to the closure of each element of the project. In response



to the IRs from the GRT regarding alternatives, a Technical Memorandum was prepared to provide a brief description of the alternatives that were considered for each element of mine closure as well as the rationale that was used to select the preferred alternative. This information is provided in the attached Supplemental Information Package.

### **Revised Pit Flooding Duration**

The pit flooding model was updated to better reflect planned water management activities at closure. The previous estimated flooding duration of 78 years was based on the assumption that runoff from the Waste Rock Management Facility (WRMF), Tailings Management Facility (TMF) and other project infrastructure would be diverted to the pits in perpetuity. However, as explained in the Version 1 Conceptual Closure and Rehabilitation Plan TSD, runoff from these areas will be released to the environment when water quality is deemed to be suitable for discharge. The pit flooding model was updated based on this plan. The model update resulted in an increase in the predicted flooding duration to approximately 218 years. A technical memorandum summarizing the revised pit flooding model results is provided in the attached Supplemental Information Package.

### **Correction to TMF and WRMF Stockpile Heights**

Information Requests received from the MNDM noted that were discrepancies between the reported heights of the TMF and WRMF in the Conceptual Closure and Rehabilitation Plan TSD and the Draft EIS/EA Report. These discrepancies were investigated and clarifying information was provided in the IR responses (MNDM-36, MNDM-37) and corrections were made to the information in the Draft EIS/EA Report. The maximum TMF and WRMF heights reported in the Version 1 Conceptual Closure and Rehabilitation Plan TSD are incorrect. The correct maximum height of the TMF will be 76 m above the lowest ground elevation and the correct maximum height of the WRMF will be 130 m above the lowest ground elevation.

### **Supplemental Information Provided in Part B**

- Technical Memorandum: Closure Alternatives (Rev 1, December 4, 2013)
- Technical Memorandum: Revised Pit Flooding Model (Rev 1, December 4, 2013)



# **PART B**

## **Supplemental Information Package**



**DATE** December 4, 2013**PROJECT No.** 13-1118-0010**TO** Alexandra Drapak  
Osisko Hammond Reef Gold**DOC. No.** 002 (Rev 1)**CC** Cathryn Moffett, Ken DeVos**FROM** Ken Bocking, Adam Auckland**EMAIL** kbocking@golder.com;  
aauckland@golder.com**OSISKO HAMMOND REEF GOLD (OHRG) PROJECT – CLOSURE ALTERNATIVES****1.0 BACKGROUND**

As part of the documentation for permitting of the Hammond Reef Gold Project a Technical Supporting Document<sup>1</sup> was submitted which described the conceptual plan for closure of the project site after mining is completed. A number of the Information Requests (IRs) from the reviewers have noted that the document describes a single preferred method of closure and rehabilitation for each element of the mine closure; it does not describe the closure alternatives that were considered.

The observation of the reviewers is correct; the conceptual closure plan document does not provide descriptions of the closure alternatives that were considered. The document was based on a formal closure plan that was prepared in draft form for eventual certification and submittal to MNDM. (The formal closure plan is currently under internal review and has not yet been submitted to MNDM.). The formal closure plan was required to follow a format which is dictated by Schedule 2 to O. Reg. 240/00 under the Mining Act. Schedule 2 requires detailed descriptions of the selected closure methods; however it does not require a discussion of alternative methods that were considered but not ultimately selected.

In the preparation of the conceptual closure plan (and also the formal closure plan), due consideration was given to possible alternative approaches that could be taken to the closure of each element of the project. The following sections of this Technical Memorandum provide a brief description of the alternatives that were considered for each element of mine closure as well as the rationale that was used to select the preferred alternative. This information is also summarized in a table in Appendix A.

**2.0 CLOSURE ALTERNATIVES AND SELECTION****2.1 Site Infrastructure****2.1.1 Selected Closure Option**

On-site access roads and haul roads not required for post-closure monitoring and maintenance will be scarified and culverts will be removed to restore natural drainage conditions. The existing site access road (hardtack /

<sup>1</sup> Golder Associates Ltd., (2013), "Hammond Reef Gold Project Conceptual Closure and Rehabilitation Plan, Version 1", Document 2012-068, February, 2013.



Sawbill) is the property of the MNR. OHRG will continue to use the access road after closure for monitoring and site maintenance activities. Such use and maintenance will follow the terms of the separate agreement between OHRG and MNR.

There will be some use of existing granular aggregate pits to complete the closure activities in the first year or two after closure occurs. After that, each aggregate area will be closed out according to the licences under the Aggregate Resources Act.

The Project transmission line will become redundant after the completion of the closure measures, including the cessation of pumping of water from the TMF Reclaim Pond and from the seepage collection ponds. The transmission line may be transferred to another party, or alternatively it will be taken down and the cables and the poles will be salvaged.

The Project facilities (e.g. the Processing Plant and equipment, the maintenance shops, the accommodation camp, the Effluent Treatment Plant, etc.) will be redundant at closure. Portable facilities such as trailers will be removed from the site. Permanent facilities will be decommissioned and demolished. Non-hazardous demolition waste will be disposed of in a solid waste landfill to be licensed within the TMF. Any hazardous materials or liquid wastes will be removed from the Project site by licensed haulers for disposal in accordance with applicable regulations. Any soils impacted by hydrocarbons will either be bio-remediated on site, or shipped to a licensed facility.

### **2.1.2 Possible Alternatives Considered**

At the time of closure, the Project site will include infrastructure (i.e., power supply, access roads, industrial buildings, etc.) that could potentially support an ongoing industrial operation. In the context of O.Reg 240/00, there could be an approved alternative land use. This scenario is unlikely to be viable because there will be similar sites available to industry that are much less remote. This implies that the power line is likely to be decommissioned and salvaged as described above. The last usage of power on the site will likely involve pumping of water collected in seepage collection facilities. Some or all of these facilities could be switched over to diesel power to accelerate the decommissioning of the main power distribution system.

As an alternative to disposing of non-hazardous solid wastes in a landfill to be established within the TMF, it would be possible to haul these wastes to the nearest existing solid waste landfill, probably in the Town of Atikokan. It is expected that the latter alternative would be substantially more expensive considering the greater haul distance and the tipping fees. In other words, it is expected that the operational cost savings would justify the effort to license and manage a landfill at the TMF. A decision as to whether or not to set up a bio-remediation facility on site would be based on economics. If environmental site assessment (Phase 2 ESA) work at the time of closure indicates that the volume of hydrocarbon contaminated soil is small, then it would be more economical to simply ship the soils off-site for treatment.

## **2.2 Tailings Management Facility**

### **2.2.1 Selected Closure Option**

As described in the conceptual closure plan, the selected measures for the TMF include using re-vegetation to stabilize the exposed tailings surface against erosion by wind and water. It is not planned to place a layer of topsoil or overburden soil on top of the tailings; rather the tailings will be directly re-vegetated by placing organic mulch, fertilizer and seeding. Erosion protected channels will be constructed to convey surface runoff where concentrated flows could occur. All runoff will continue to report to the TMF Reclaim Pond. Initially, the water in the Reclaim Pond will be pumped to the Open Pit; however when the water quality is suitable, the Reclaim Pond

spillway will be lowered and the excess water will be allowed to drain through an excavated channel for discharge into Sawbill Bay. Water collected in the seepage collection ponds will continue to be pumped back into the TMF Reclaim Pond until such time as the water quality in the individual ponds becomes acceptable for direct discharge. When the water quality is shown to consistently meet acceptable discharge levels, individual seepage pond dykes will be breached and their pumping systems will be removed.

## **2.2.2 Possible Alternatives Considered**

In theory at least, the tailings could be relocated from the TMF to the open pit after closure. The cost of moving 315 million tonnes of tailings, even by slurry transport, would be prohibitive.

The surface area of tailings requiring re-vegetation will be roughly 675 hectares. Placement of a 0.3 m layer of topsoil over the area would require over 2.0 Mm<sup>3</sup> of topsoil. This volume would simply not be available. It would also be possible to place a layer of overburden soil over the tailings surface as a base for re-vegetation. The tailings surface is expected to be soft, especially when wet. Equipment trafficability considerations would make it impracticable to place overburden in a thickness less than 1.0 m. This means that about 6.8 Mm<sup>3</sup> of overburden would be required. By comparison, the mining plan indicates that about 9.2 Mt (4.5 Mm<sup>3</sup>) of overburden will be removed during mining, so it is expected that there would be insufficient material available to cover the TMF. In any case, the cost of loading the overburden from the stockpile near the Open Pits, hauling it to the TMF and placing it would be prohibitive.

In considering the chemistry of the existing tailings, and in consideration of other successful revegetation efforts on closed tailings facilities, direct revegetation is considered feasible, practical and achievable at this site and is the preferred alternative. The alternative of direct revegetation was selected.

## **2.3 Waste Rock Stockpile**

### **2.3.1 Selected Closure Option**

At closure, the waste rock stockpile will contain about 215 Mt of waste rock. The stockpile will have conservative sideslopes of about 2.5:1 (H:V) overall. The rock will comprise hard fragments that are physically stable (i.e., they will not be subject to weathering or erosion) and it will also be geochemically stable (i.e., it will not generate acidic runoff). As described in the conceptual closure plan, the selected measures for the Waste Rock Stockpile include minor regrading of the top surface and implementation of drainage measures to convey runoff to the toe of the stockpile without erosion. It is not proposed to place any soil cover over the waste rock pile. No active revegetation of the pile surface is proposed.

Water collected in the four seepage collection ponds will continue to be pumped back into the Open Pit until such time as the water quality in the individual ponds becomes acceptable for direct discharge. When the water quality is shown to consistently meet acceptable discharge levels, individual seepage pond dykes will be breached and their pumping systems will be removed.

### **2.3.2 Possible Alternatives Considered**

In theory at least, some of the waste rock could be relocated from the stockpile back to the open pit after closure. (Because of bulking, not all of the rock could be contained in the Open Pit voids). Because the waste rock pile is expected to be both physically and geochemically stable if left in place, the only benefit of such a relocation would be aesthetic. The cost of moving a large fraction of the 215 Mt of waste rock would be prohibitive, which is the reason that there are few if any examples of this having been done at mines in Ontario.

It would be possible to place a soil cover over the surface of the waste rock pile. There would be no benefit from such a cover in terms of reducing acid generation, because the rock is expected to be geochemically stable in any case. A cover would be expected to decrease the amount of infiltration, which would as a result reduce the volume of water reporting to the seepage collection ponds. A simple reduction in the seepage flows would not eliminate the need for the planned continuation of the toe seepage collection for some period after closure. In short, placement of a soil cover would have no real benefit compared to the current closure plan.

It would be possible to actively re-vegetate the surface of the waste rock pile. This would require the placement of either a layer of overburden soil or an organic material such as pulp mill sludge over the surface, followed by fertilization and seeding. Because the waste rock pile is expected to be non-weathering and resistant to erosion, vegetation is not required for physical stability. Placement of a soil layer, combined with plant transpiration effects would reduce the amount of infiltration into the stockpile. This in turn would merely reduce the flows reporting to the seepage collection points; it would not eliminate them. Seepage collection would still be required. The only benefit of active revegetation would be aesthetic. Given the remote location of the mine site, the visibility of the stockpile is relatively limited.

## **2.4 Overburden Stockpile**

### **2.4.1 Selected Closure Option**

Based on the mining plan, the Overburden Stockpile will contain about 9.2 Mt (4.5 Mm<sup>3</sup>) of overburden. During pit stripping, the overburden will be placed into the stockpile in a stable configuration with overall sideslopes of about 3:1 (H:V). There will be four seepage collection points.

At closure, some of the overburden will be used for regrading around the Project site. The top surface of the material remaining in the stockpile will be graded and drainage measures will be put in place. The overburden is expected to support vegetation, so the surface will be directly revegetated, without the use of topsoil. Water in the four seepage collection points will continue to be monitored after closure. The seepage water will continue to be pumped to the open pits until such time as the water quality becomes acceptable for direct discharge to the environment. At that time, the ponds will be breached and the pumping systems will be removed.

### **2.4.2 Possible Alternatives Considered**

One alternative would be to use up the entire overburden stockpile around the Project site for regrading or covering of decommissioned facilities. This would make the closure measures for the overburden stockpile redundant. It would be costly to load, haul and place the large volume of overburden around the site. If the overburden was widely dispersed around the site it would likely generate greater turbidity loadings than if it was stabilized in place in the Overburden Stockpile as is proposed. Leaving it in place also provides the opportunity to use the existing seepage collection system to monitor and control runoff and seepage until the pile is stabilized.

## **2.5 Low Grade Ore Stockpile**

### **2.5.1 Selected Closure Option**

As described in the conceptual closure plan, it is expected that the material in the low-grade ore stockpile will be milled as ore during the operating phase of the project. As a result, the stockpile will no longer exist at closure and no specific closure measures will be required. If for some reason, some of the low-grade ore stockpile remains when the project ceases, it will be closed in the same manner as the waste rock stockpile. In such a case, water in the three seepage collection ponds would continue to be monitored after closure. Water in these ponds would continue to be pumped into the Open Pits until such time as the water quality in the individual

ponds becomes acceptable for direct discharge. When that occurs consistently, individual seepage pond dykes will be breached and their pumping systems will be removed.

## **2.5.2 Possible Alternatives Considered**

Consideration of alternatives applies only to the contingency that some of the low-grade ore will remain at the time of closure. The alternatives would be the same as those identified above for the waste rock stockpile (i.e., relocation to the Open Pits, placement of a soil cover or active re-vegetation. The consideration of these alternatives is the same as for the waste rock stockpiles.

## **2.6 Open Pits**

### **2.6.1 Selected Closure Option**

As described in the conceptual closure plan, pumping of water out of the Open Pits will cease at closure and the pits will be allowed to slowly fill with water. At closure, one channel will be cut through bedrock between the East Pit and the West Pit to hydraulically connect them. At the same time, a second channel will be cut through the western perimeter of the West Pit to direct overflow from both pits into Upper Marmion Reservoir. Preliminary modelling indicates that it will take about 220 years for the water level in the open pits to rise to an elevation of 420 m, at which time the flooded pits will overflow into Upper Marmion Reservoir. In the initial years after closure, some water will be pumped into the open pits from several sources around the mine site (i.e. from the TMF Reclaim Pond and from the seepage collection ponds around the waste rock stockpile). Such pumping will be discontinued after a few years, once the water quality of these site sources improves to the point where it can be discharged directly to the environment. Aside from this initial pumping, flooding of the open pits will be “passive”, in that there is no intention to pump water in from the Upper Marmion Reservoir to accelerate the backflooding.

Based on the post-closure water balance, it is estimated that about 497,400 m<sup>3</sup>/year will overflow from the flooded open pits. Before overflow occurs, the water quality at the top of the flooded open pits will be evaluated and a decision will be made regarding post-overflow water treatment if required. It is expected that stratification of water in the flooded open pits will result in surficial water quality that is suitable for discharge into the Upper Marmion Reservoir. However, if stratification of the water does not produce acceptable water quality, additional treatment options such as in-pit treatment will be considered.

Just prior to closure, a rock mechanic evaluation of the open pit slopes will be carried out. This evaluation will establish a “safe line”, taking into account any incipient instability of the pit walls. A rock barrier wall will be constructed around the perimeter of the open pits outside of the safe line to prevent inadvertent access by the public to any slopes.

It is not proposed to develop the flooded Open Pits as aquatic habitat.

### **2.6.2 Possible Alternatives Considered**

In theory at least, the open pits could be backfilled using much of the waste rock in the waste rock stockpile. Because the waste rock is not potentially acid generating, there would be no advantage in relocating the rock to the open pits for eventual flooding in terms of geochemical stability. Moreover, the cost of moving a large fraction of the 215 Mt of waste rock would be prohibitive.

It would be possible to accelerate the backflooding of the open pits by actively pumping water from the Upper Marmion Reservoir into the open pits. Depending on the pumping rate selected, it would be quite feasible to achieve overflow within 5 to 10 years. There has been no indication that bedrock exposed on the walls of the

open pits would be susceptible to generating acid; therefore accelerated flooding of the open pits does not present an advantage from a geochemical perspective. Active flooding would involve the abstraction of a relatively large volume of water from the Upper Marmion Reservoir, which would have an impact on the generation of hydropower. Active flooding would mean that overflow from the open pits into the Upper Marmion Reservoir would occur at a much earlier date than the passive flooding scenario that has been selected. This is a disadvantage in that the receiver would be subject to possible impacts sooner. It is expected that active flooding would result in a greater degree of mixing; in other words the benefits of stratification of water in the flooded open pits would be greater with the passive flooding scenario.

It may be possible to enhance the value of the flooded open pits as potential future aquatic habitat. This could, for example, involve adjusting the pit bench design to provide shallow water littoral habitat around the pit perimeter. The decision was made to not do this because of the inherent hazards related to the open pit walls. Establishment of a fishery in the open pits would encourage access by fishermen, which is contrary to the objective of the boulder wall, which is to prevent inadvertent human access.

## **2.7 Site Water Management**

### **2.7.1 Selected Closure Option**

For a year or two after closure, (until such time that the TMF water quality is deemed suitable for direct discharge into Sawbill Bay), water will continue to be pumped from the TMF Reclaim Pond; however pumping of this water to the Processing Plant Collection Pond (PPCP) will cease upon closure and instead the reclaim water will be directed into the open pits. Similarly, water pumped from the seepage collection ponds around the toes of the stockpiles (i.e., the Waste Rock Stockpile, the Low-grade Ore Stockpile and the Overburden Stockpile) will be pumped to the open pits rather than to the PPCP.

Once the Processing Plant and other Project infrastructure has been demolished and the Project site has been re-vegetated, the remaining runoff reporting to the PPCP is not anticipated to require treatment. At that time, the PPCP and the Effluent Treatment Plant (ETP) will be decommissioned, the perimeter dykes will be breached and normal runoff patterns will be restored.

As discussed above, the open pits will be allowed to flood passively after closure and it is expected that the flooded open pits will overflow to the Upper Marmion Reservoir after about 220 years. It is expected that stratification of water in the flooded open pits will result in surficial water quality that is suitable for discharge into the Upper Marmion Reservoir. However, if stratification of the water does not produce acceptable water quality, additional treatment options such as in-pit treatment will be considered.

### **2.7.2 Possible Alternatives Considered**

The potential alternative of active flooding of the open pits by pumping water from the Upper Marmion Reservoir is discussed in Section 2.6.2.

Rather than diverting post-closure site flows to the Open Pits, it would be possible to continue the operational procedure of collecting these flows into the PPCP for treatment in the ETP and release to the Upper Marmion Reservoir. This would mean that the discharge of treated effluent would continue after mining ceases. (In this case, treatment and discharge would eventually be discontinued, once each of the individual flow sources (i.e., the TMF Reclaim Pond water, and the water collected in the seepage collection ponds) was deemed to be suitable for direct discharge to the environment.) By contrast, the proposed diversion of these flows into the Open Pits would mean there would be no effluent discharge for about 220 years, until the open pits overflowed. The selected option of diversion of site flows into the Open Pits therefore entails less potential impact to the



Upper Marmion Reservoir. Treatment and release of the site flows would not prevent eventual overflow of the Open Pits; rather pit overflow would occur later by several decades. Under either scenario, the site flows (i.e., from the TMF Reclaim Pond and the seepage collection ponds) would only be released if and when they were suitable for direct discharge without causing impact.

### 3.0 CONCLUSION

A number of potential alternatives were considered when each element of the conceptual closure plan was developed. This technical memorandum describes those alternatives and also the rationale that was followed to select the preferred alternative for each element.



Ken Bocking  
Principal

KAB/AA/KDV/sp



Adam Auckland  
Project Manager

Attachment: Appendix A – Summary of Closure Alternatives

\\golder.gds\gal\mississauga\active\2013\1118\13-1118-0010 osisko-hammond reef - ea support\006 environmental\2005 closure\doc002\_closure alternatives\doc002\_rev 1\13-1118-0010\_doc002\_closure alternatives\_rev 1\_4dec2013.docx

# APPENDIX A

## APPENDIX A - SUMMARY OF CLOSURE ALTERNATIVES



**Table 1: Summary of Closure Alternatives**

Mine Facility	Selected Closure Option	Alternatives Considered	Rationale for Selection
Site Infrastructure	<ul style="list-style-type: none"> <li>- Scarify on-site access/haul roads that are redundant and remove culverts to restore natural drainage conditions</li> <li>- Continue to use Hardtack/Sawbill site access road to monitor and maintain site. This road is the property of MNR.</li> <li>- Close granular aggregate pit areas according to licences under the Aggregate Resources Act</li> <li>- Transfer transmission line to another party or decommission and salvage cables and poles</li> <li>- Decommission and demolish permanent facilities. Remove portable facilities</li> <li>- Dispose non-hazardous waste (debris from closure demolition) in a licenced solid waste landfill within the TMF</li> <li>- Remove and dispose any hazardous waste in accordance with applicable regulations.</li> <li>- Bio-remediate on-site or ship and hydrocarbon impacted soils to a licenced facility.</li> </ul>	<ul style="list-style-type: none"> <li>- Leave infrastructure (i.e., transmission lines, access roads and industrial buildings) in place to support ongoing industrial operation</li> <li>- Haul non-hazardous waste to the nearest solid waste landfill</li> <li>- Haul to an existing dump off-site</li> </ul>	<ul style="list-style-type: none"> <li>- Need or potential use of infrastructure is unlikely because similar, less remote, sites will be available to industry</li> <li>- Off-site disposal of non-hazardous waste would be substantially more expensive due to haul distance and tipping fees.</li> <li>- Decision to be based on quantity of hydrocarbon contaminated soil. If small, haul off-site; if large, bio-remediate on site.</li> </ul>

## APPENDIX A - SUMMARY OF CLOSURE ALTERNATIVES



Mine Facility	Selected Closure Option	Alternatives Considered	Rationale for Selection
Tailings Management Facility	<ul style="list-style-type: none"> <li>- Re-vegetate exposed tailings surface directly utilizing organic mulch, fertilizer and seeding to stabilize against erosion by wind and water</li> <li>- Construct erosion protected channels to convey surface runoff to the TMF Reclaim Pond</li> <li>- Discharge reclaim water to the open pit until water quality is suitable to be discharged to Sawbill Bay through an excavated channel</li> <li>- Pump water from the seepage collection ponds to the TMF Reclaim Pond until water quality is suitable for discharge. Decommission ponds when pumping ceases.</li> </ul>	<ul style="list-style-type: none"> <li>- Relocate tailings from the TMF to the open pit after closure</li> <li>- Revegetate the tailings utilizing an overburden cover</li> <li>- Revegetate the tailings using topsoil</li> <li>- Refer to Site Water Management section for water management alternatives</li> </ul>	<ul style="list-style-type: none"> <li>- Transportation of tailings from the TMF to the open pit after closure would be prohibitively costly.</li> <li>- Hauling and placement of overburden to cover the tailings would be prohibitively costly</li> <li>- Insufficient topsoil will be available at site to completely cover the tailings to a suitable thickness</li> <li>- The tailings deposit will be soft, so special construction techniques would be required to place overburden over the tailings</li> </ul>
Waste Rock Stockpile	<ul style="list-style-type: none"> <li>- Re-grade top surface and implement drainage measures to convey runoff to the toe of the stockpile without erosion</li> <li>- Do not place soil cover or vegetation (i.e., allow re-vegetation to occur naturally)</li> <li>- Pump water from the seepage collection ponds to the Open Pit until water quality is suitable for discharge. Decommission ponds when pumping ceases.</li> </ul>	<ul style="list-style-type: none"> <li>- Relocate waste rock into the Open Pits</li> <li>- Provide a soil cover and revegetate on the waste rock stockpile</li> <li>- Refer to Site Water Management section for water management alternatives</li> </ul>	<ul style="list-style-type: none"> <li>- Relocating the waste rock into the Open Pits or covering it with soil and vegetation is not required because the waste rock is expected to be physically and geochemically stable. Not all of the waste rock would fit in the Open Pits. Relocation would be prohibitively costly.</li> <li>- Placement of a soil or vegetation cover would not eliminate infiltration, thus seepage collection ponds would still be required</li> <li>- Visibility of the stockpile is limited due to remoteness, thus aesthetic benefits of revegetation are limited</li> </ul>

## APPENDIX A - SUMMARY OF CLOSURE ALTERNATIVES



Mine Facility	Selected Closure Option	Alternatives Considered	Rationale for Selection
Overburden Stockpile	<ul style="list-style-type: none"> <li>- Grade site facility areas using some overburden from stockpile</li> <li>- Re-grade of the top surface of the stockpile and implement drainage measures</li> <li>- Vegetate surface without topsoil</li> <li>- Pump water from the seepage collection ponds to the Open Pit until water quality is suitable for discharge. Decommission ponds when pumping ceases.</li> </ul>	<ul style="list-style-type: none"> <li>- Eliminate the Overburden Stockpile by using all of the overburden to re-grade or cover the other decommissioned facilities on site.</li> <li>- Refer to Site Water Management section for water management alternatives</li> </ul>	<ul style="list-style-type: none"> <li>- Loading, hauling, and placement of overburden around the project site would be costly</li> <li>- Distribution of overburden throughout the site would increase turbidity of overall site runoff</li> <li>- Leaving the stockpile in place allows for the continued use of seepage collection system to control and monitor runoff and seepage</li> </ul>
Low Grade Ore Stockpile	<ul style="list-style-type: none"> <li>- Mill (and thus remove) the low grade ore stockpile during operations</li> <li>- If, as a contingency, low grade ore remains in a stockpile at closure, it will be closed in the same manner as the overburden stockpile (see above)</li> </ul>	<ul style="list-style-type: none"> <li>- If a stockpile remains at closure, the alternatives would be the same as those alternatives considered for the waste rock stockpile</li> </ul>	<ul style="list-style-type: none"> <li>- Rationale is the same as those outlined for the waste rock stockpile</li> </ul>

## APPENDIX A - SUMMARY OF CLOSURE ALTERNATIVES



Mine Facility	Selected Closure Option	Alternatives Considered	Rationale for Selection
Open Pits	<ul style="list-style-type: none"> <li>- Allow Open Pits to backflood naturally without the use of water from Upper Marmion Reservoir and cut a channel between the East and West Pits to hydraulically connect them</li> <li>- Construct a discharge channel from the West Pit for discharge to Upper Marmion Reservoir (discharge estimated to begin 70 to 78 years after pit backflooding begins)</li> <li>- Discharge water pumped from various seepage and runoff collection ponds to the open pits until the pond water quality is suitable for discharge.</li> <li>- As a contingency, treat water in the pit prior to overflow if water quality is not suitable for discharge (overflow water quality is expected to be acceptable).</li> <li>- Complete a slope stability assessment of the pit to establish a “safeline” and construct a rock barrier to prevent inadvertent access</li> <li>- Development of aquatic habitats within the open pits is not proposed</li> </ul>	<ul style="list-style-type: none"> <li>- Backfill the open pits with waste rock from the waste rock stockpile</li> <li>- Accelerate flooding by actively pumping water from the Upper Marmion Reservoir into the open pits</li> <li>- Enhance the flooded open pits for use as an aquatic habitat</li> <li>- Refer to Site Water Management section for water management alternatives</li> </ul>	<ul style="list-style-type: none"> <li>- Backfilling the open pits with waste rock would be prohibitively costly and is not required because the waste rock is expected to be physically and geochemically stable</li> <li>- Actively pumping water from the Upper Marmion Reservoir would impact the management of the reservoir system and the generation of hydropower</li> <li>- Active pumping would also induce greater mixing within the open pits potentially inhibiting stratification which is beneficial to surficial lake water quality</li> <li>- Accelerated flooding is not geochemically advantageous because the exposed bedrock is not acid generating</li> <li>- Altering pit walls for aquatic habitation could potentially reduce stability</li> <li>- Creation of aquatic habitats may encourage access by fishermen to the flooded Open Pits; which is contrary to the purpose of the rock barrier wall</li> </ul>

**APPENDIX A - SUMMARY OF CLOSURE ALTERNATIVES**



Mine Facility	Selected Closure Option	Alternatives Considered	Rationale for Selection
Site Water Management	<ul style="list-style-type: none"> <li>- Pump water from the TMF Reclaim Pond and the site seepage collection ponds to the open pits</li> <li>- Decommission the Processing Plant Collection Pond (PPCP) and restore normal runoff patterns after the Processing Plant and other project infrastructure have been demolished</li> <li>- Flood open pit passively over a period of approximately 70 to 78 years</li> </ul>	<ul style="list-style-type: none"> <li>- Accelerated flooding of the open pits is discussed above</li> <li>- Continued treatment of water from the Reclaim Pond and seepage collection ponds at the Effluent Treatment Plant (ETP)</li> </ul>	<ul style="list-style-type: none"> <li>- Rationale for the flooding alternatives is discussed above</li> <li>- Continuing treatment of contaminated water at the ETP would entail discharge into the Upper Marmion Reservoir continuing after operations cease. This would cause more impact on the Upper Marmion Reservoir and prolong flooding of the open pits</li> <li>- Water in the flooded Open Pits is expected to stratify, such that the water that eventually overflows will be similar in quality to runoff. If, as a contingency, the overflow water is not suitable for discharge, it can be treated in-pit</li> </ul>

**DATE** December 4, 2013**PROJECT No.** 13-1118-0010**TO** Alexandra Drapack  
Osisko Hammond Reef Gold**DOC. No.** 007 (Rev 1)**CC** Cathryn Moffett, Adam Auckland, Ken De Vos**FROM** Ken Bocking, Brian Andruchow**EMAIL** Ken\_Bocking@golder.com**OSISKO HAMMOND REEF GOLD PROJECT – REVISED PIT FLOODING MODEL****1.0 INTRODUCTION**

Golder Associates Ltd. (Golder) was retained by Osisko to develop a closure plan for the Hammond Reef Gold Project, in support of the environmental impact assessment (EIA) and the feasibility study (FS). As part of the EIA and FS, an estimation of the time required for the open pits to flood after cessation of operations was required. The time required for the open pits to flood at closure was modelled, giving consideration to the long term environmental conditions, site grading, and pumping of collected surface water flows back to the open pit which may occur for a period of time during closure. This technical memorandum is provided as an addendum to the pit flooding model results previously presented in the Site Water Quality TSD.

**2.0 MODEL REVISIONS**

The pit flooding model was updated with revised surface water inflows to better reflect the expected conditions and planned water management activities at closure (Golder, 2012). These changes comprise the following:

- At closure, the dyke on the west side of the Process Plant Collection Pond (PPCP) will be breached, allowing the pond to discharge into the East Pit. Surface water flows reporting to the PPCP, which will be generated from the remediated plant site watershed, will therefore flow into the open pit for perpetuity after closure.
- It is assumed that seepage and runoff collected in the TMF surface water collection system will be pumped back to the open pits for a 3 year period following closure. (After that, the TMF flows will be routed to Sawbill Bay.)
- It is assumed that seepage collected in the seepage collection ponds around the Waste Rock Area (WRA) the Overburden Stockpile and the reclaimed Low Grade Ore Stockpile (i.e., SCPs 6 through 14) will be pumped back to the open pits for a 5 year period following closure. After that, these SCPs will be breached allowing the seepage to flow directly to the environment.
- It is assumed that surface runoff other contact areas (i.e., the Intermediate Collection Pond, the Ore Stockpile area, the Detonator Storage Area and the Emulsion Plant area) will be pumped back to the open pits for a 5 year period following closure. After that, flows from these areas will be allowed to flow directly to the environment.





As explained in the conceptual closure plan, (Golder, 2012), water flows from the TMF, WRA and Overburden Stockpile will be directed towards the Open Pit until the quality from each becomes acceptable for direct environmental discharge. At this time, it is not known how long pumping to the Open Pits will actually be required. The assumptions made for this pit flooding model (i.e. 3 years for the TMF and 5 years for the WRA, Overburden Stockpile and the other areas) were based on professional experience.

No further revisions to the model were made, and all other inputs are as discussed in Section 3.8 of the Site Water Quality TSD.

## 2.1 Distribution of Flows

The contribution of each mine facility to the overall quantity of surface runoff flow directed to the Open Pits is presented in Figures 1a and 1b for the duration of the model run. The TMF contribution presented in Figure 1a is for the first 3 years of closure, however, in actuality the flow will only be pumped to the east pit until the water quality is acceptable for direct discharge to the environment. In the initial 3 years after closure, before it is released to the environment, the TMF will contribute the largest percentage of runoff at 63%. In the long term after closure, precipitation to pit walls and directly to the pit lakes will contribute the largest percentage of runoff at 56% with the remaining 44% sourced from the decommissioned process plant site.

Figure 1c presents the contribution of each flow component into the Open Pits as a percentage of the total pit volume at overflow. Direct precipitation and inflow from the PPCP are expected to be the biggest contributors of water to the pit lakes, contributing 72.8% and 16.8% of the total pit lake volume, respectively. Pumping of the TMF runoff back to the Open Pits is expected to only contribute 4.3% of total pit lake volume.

## 3.0 PIT FLOODING MODEL RESULTS

The pit flooding model was run under the average climatic conditions. While the yearly climatic conditions will undoubtedly vary from the average conditions, the climatic conditions over the duration of time required to flood the pits is expected to converge to the long-term average conditions.

The duration of time required to flood the open pits will be mainly dependent on the upstream catchment areas. It is expected that, during closure, surface water flows from the various mine facilities will be directed towards the open pits, until their quality becomes acceptable for direct environmental discharge. At this time, it is unknown for how long water which has been in contact with the remediated mine facilities will require pumping to the open pits. The pit flooding model was run under the assumption that the surface waters collected in the surface water collection system pumping stations would be pumped back to the open pits for a period of 5 years following closure, with the exception of the process plant site catchment which will flow into the pits for perpetuity, and the TMF pumping stations which are expected to only be pumped back to the open pits for a period of 3 years following closure.

Figure 2 shows the predicted volumes of water in the West Pit and the East Pit on an annual basis during the closure period assuming an estimated initial seepage rate of 740 m<sup>3</sup>/day. The seepage rate into the open pits will decrease from the predicted maximum value as the water elevation in the open pits rises, due to the reduction in driving head. The rate of seepage into the open pits would decrease to 0 m<sup>3</sup>/h if the water level in the pit lakes becomes equivalent to the phreatic surface in the adjacent ground. For the purposes of this model the water elevation at which point seepage into the open pits ceases has been taken as 431.0 m, the approximate elevation of Mitta Lake under existing conditions. The seepage inflow to the open pits was modelled to linearly decrease from the maximum value at the pit floor to 0 m<sup>3</sup>/h when the pit lake level is at elevation 431.0 m.

Table 1 provides an estimate as to the number of years required after closure for the pits to flood, based on the expected initial groundwater inflow rate. To evaluate the sensitivity of flooding duration on groundwater seepage rates, seepage rates were varied by one order of magnitude from 74 m<sup>3</sup>/day to 7,400 m<sup>3</sup>/day. The results of this sensitivity analysis are provided in Table 1.

**Table 1: Pit Flooding Model Results**

Initial Seepage Rate	Years to flood	
	West Pit	East Pit
74 m <sup>3</sup> /day	231	75
740 m <sup>3</sup> /day	218	70
7400 m <sup>3</sup> /day	144	44

Notes:

1. When the water level in the East Pit reaches 420 m, it will overflow into the West Pit.
2. When the water level in the West Pit reaches 420 m, it will overflow through a constructed channel into Marmion Reservoir.
3. The initial seepage rate is with the pits empty. The inflows decrease as the pits fill with water.

A seepage rate one order of magnitude less than the predicted value was estimated to increase the time for pit flooding time by 13 years. An increase of the predicted seepage rate by one order of magnitude was estimated to reduce the pit flooding time by 74 years.

A sensitivity analysis was also carried out on the assumed waste rock backfill void ratio of 0.5. The model was run using a void ratio ranging from 0.3 to 1.0. The pit flooding time increased by 0.3 years for a void ratio of 0.3, and decreased by 0.2 years for a void ratio of 1.0, compared to the results predicted for a void ratio of 0.5. The void ratio of the waste rock backfill has minimal effect on the model results because of the small volume of backfilled material in comparison to the total pit lake volume.

A pit flooding of 218 years has been carried forward and included in the Environmental Impact Statement/Environmental Assessment (EIS/EA) Report for the Hammond Reef Gold Project. This flooding time is based on average hydrologic conditions, an estimated initial seepage rate of 740 m<sup>3</sup>/day and a waste rock void ratio of 0.5.

## 4.0 CLOSING REMARKS

We trust that the results of the revised pit flooding model meet your requirements at this time. Please do not hesitate to contact us should you need additional information or clarification.

### GOLDER ASSOCIATES LTD.



Brian Andruchow  
Mine Waste Specialist



Ken Bocking  
Principal

BA/KB/sp

#### Attachments:

Figure 1a –Flow Contribution to the East Pit during Closure  
Figure 1b –Flow Contribution to the West Pit during Closure  
Figure 1c – Flow Contribution to Total Pit Volume at Overflow by Facility  
Figure 2 – Pit Flooding Model Results

\\golder.gds\gal\mississauga\active\2013\1118\13-1118-0010 osisko-hammond reef - ea support\006 environmental\2005 closure\doc007\_rev 0\_revised pit flooding memo\rev 1\13-1118-0010\_doc007\_revised pit flooding memo\_rev 1\_4dec2013.docx

## REFERENCES

Golder [Golder Associates Ltd.] (2012). "Conceptual Closure and Rehabilitation Plan, Version 0.1", November 2012. Project No. 10-1118-0020.

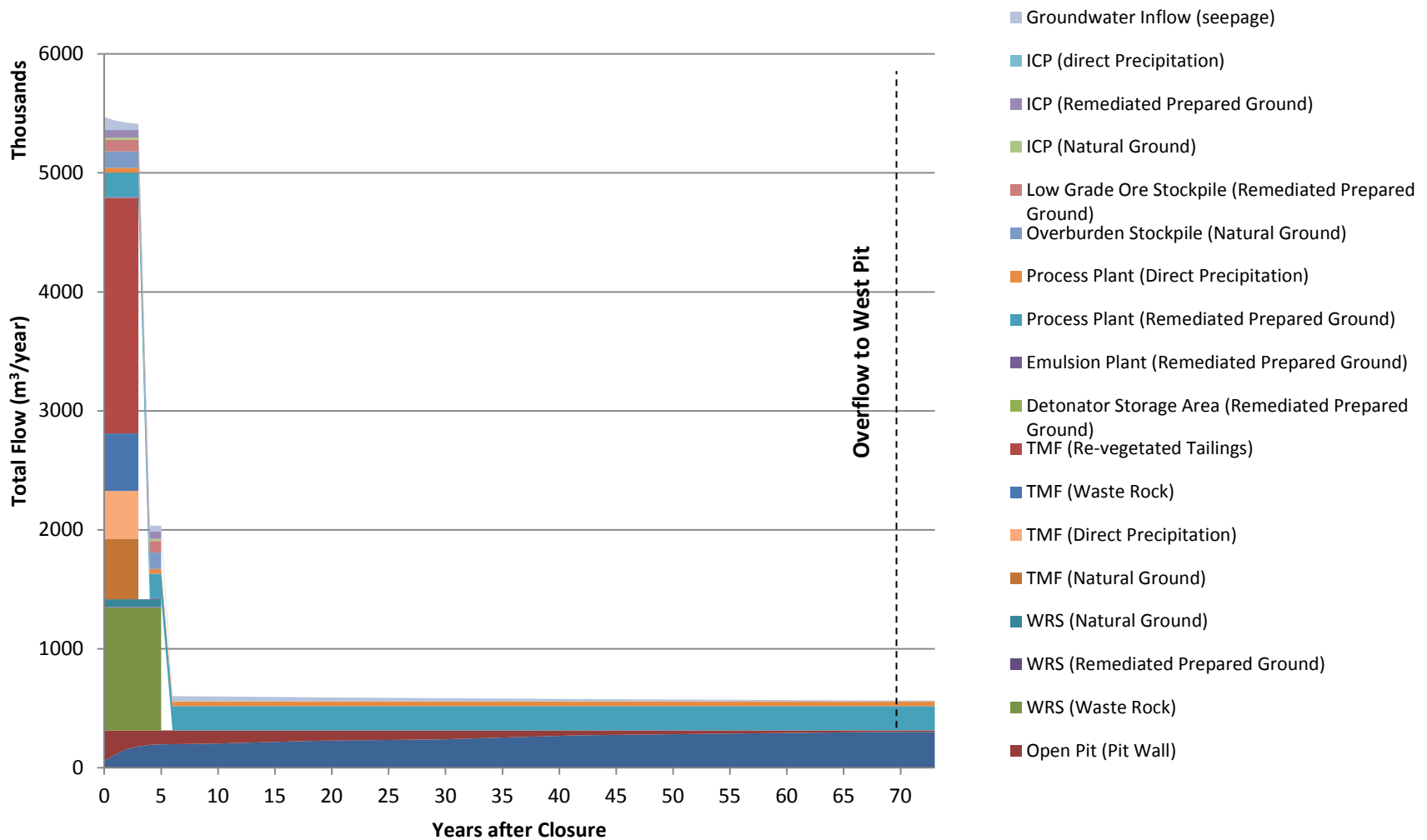

**FLOW CONTRIBUTION TO THE EAST PIT  
DURING CLOSURE**

PROJECT NO: 13-1118-0010	DATE: October 2013
BY: BA	Review: KB

**Osisko Hammond Reef Gold Project**

**FIGURE 1a**

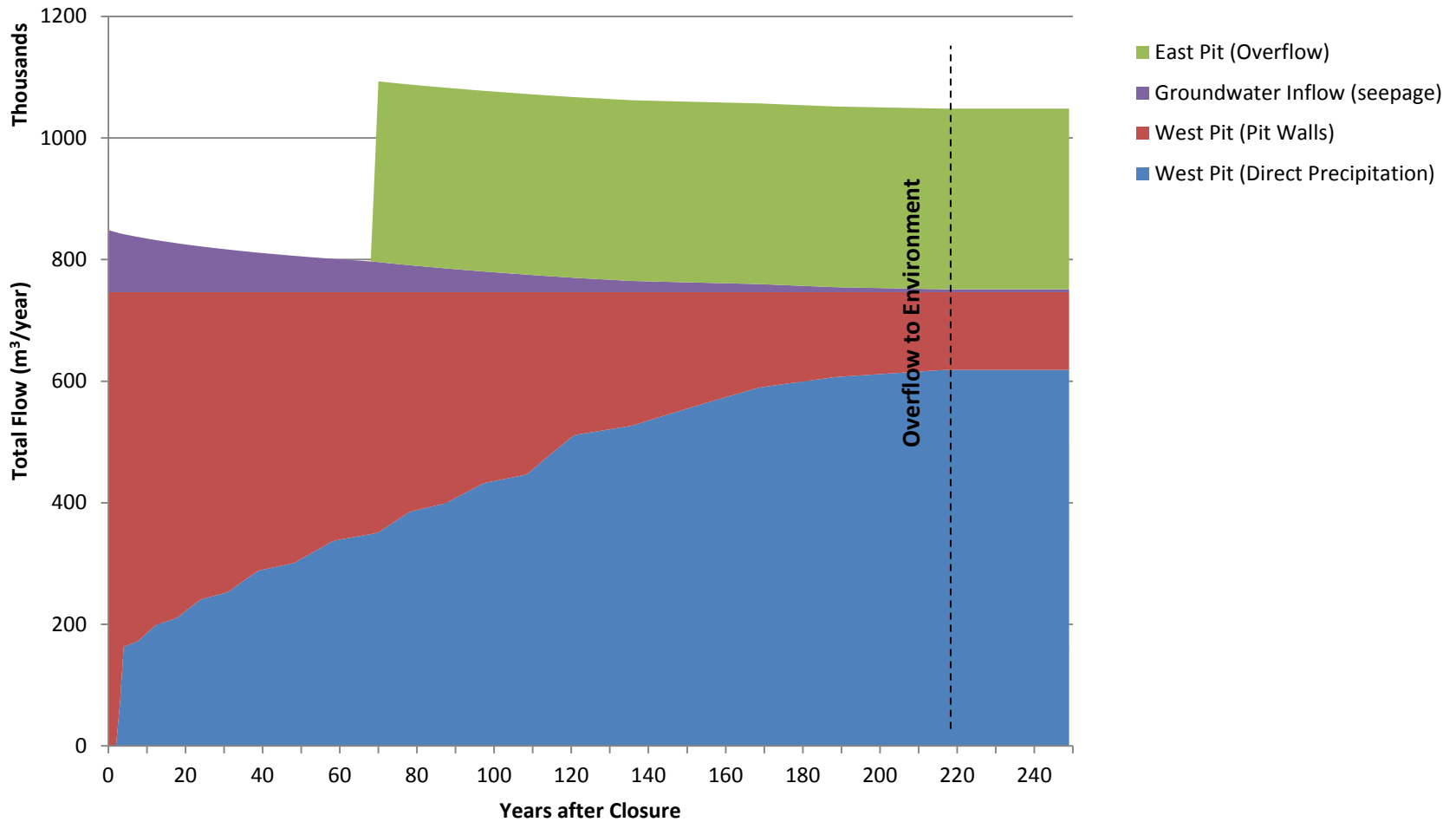

**FLOW CONTRIBUTION TO THE WEST PIT  
DURING CLOSURE**

PROJECT NO: 13-1118-0010	DATE:	October 2013
BY: BA	Review:	KB

**Osisko Hammond Reef Gold Project**

**Figure 1b**

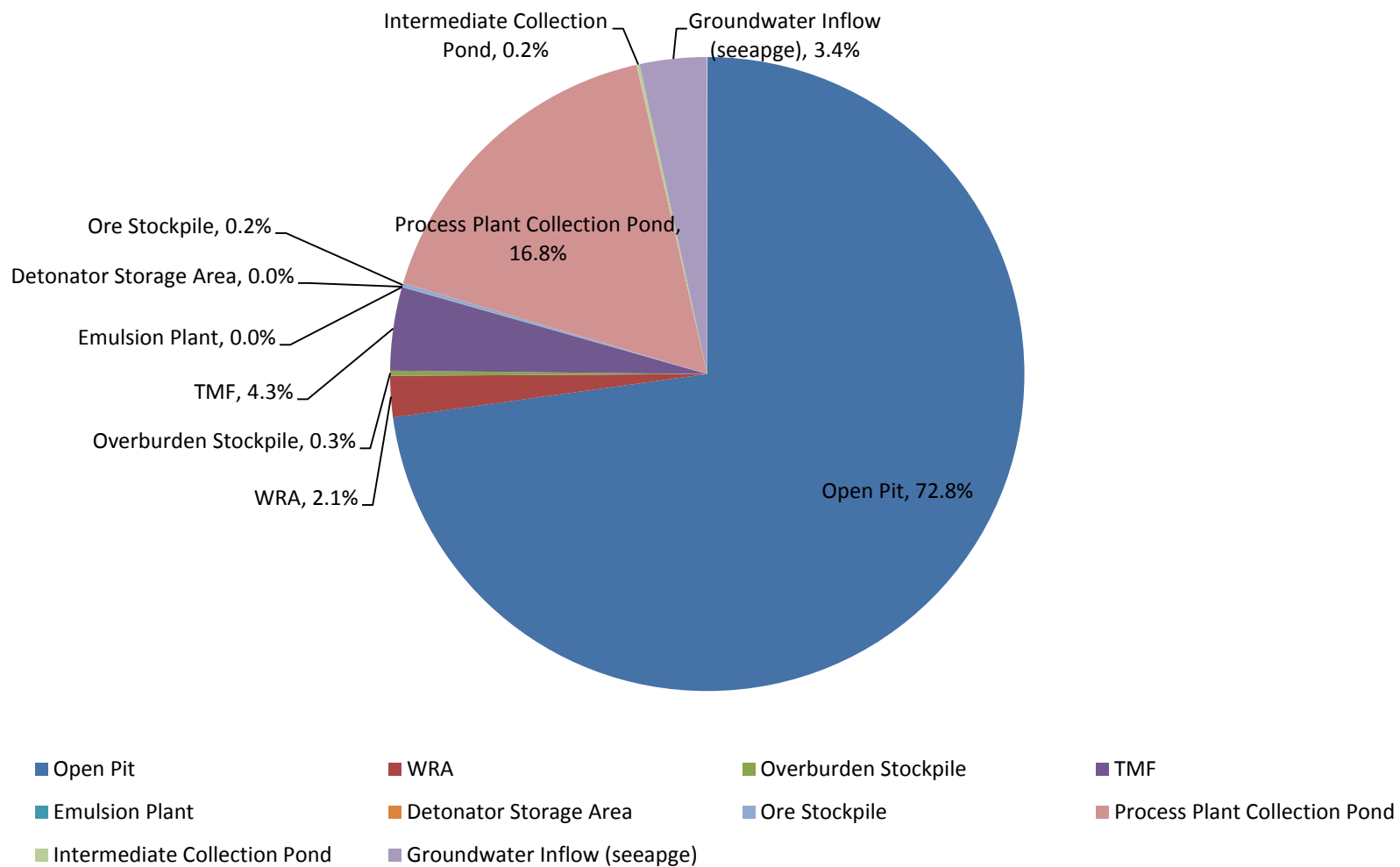

**FLOW CONTRIBUTION TO TOTAL PIT VOLUME AT OVERFLOW BY FACILITY**

PROJECT NO: 13-1118-0010	DATE: OCT. 2013
BY: BA	Review: KB

**Osisko Hammond Reef Gold Project**

**FIGURE 1c**

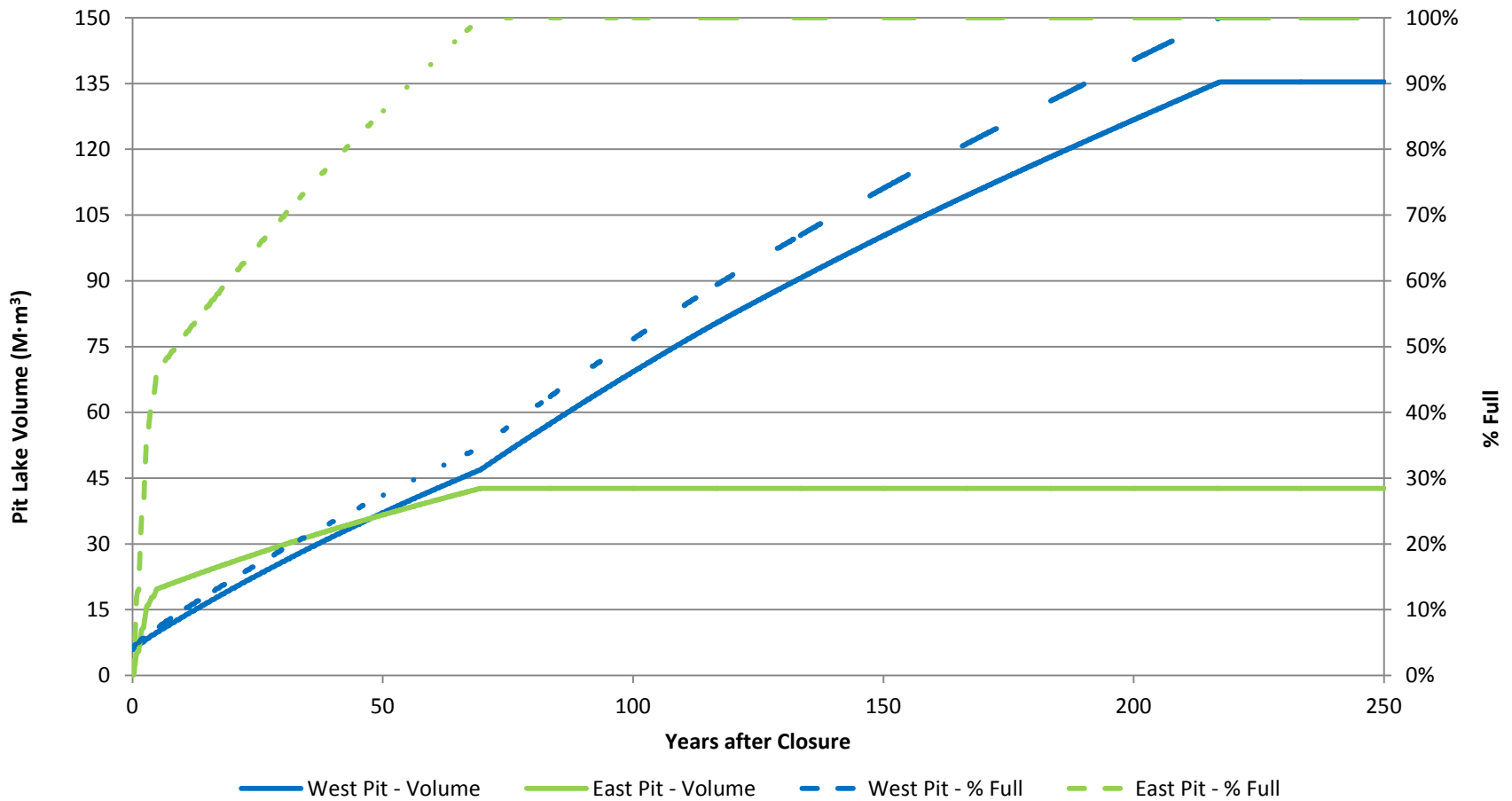

**PIT FLOODING MODEL RESULTS**  
**CLIMATIC CONDITIONS: AVERAGE**  
**PIT SEEPAGE RATE: 740 m<sup>3</sup>/h**

PROJECT NO: 13-1118-0010	DATE:	October 2013
BY: BA	Review:	KB

**Osisko Hammond Reef Gold Project**

**FIGURE 2**



# **PART C**

## **Conceptual Closure and Rehabilitation Plan, Version 1**



February 2013



# HAMMOND REEF GOLD PROJECT Conceptual Closure and Rehabilitation Plan

## VERSION 1

**Submitted to:**

Osisko Hammond Reef Gold Ltd.  
155 University Avenue, Suite 1440  
Toronto, Ontario M5H 3B7

**Project Number:** 10-1118-0020

**Document Number:** 2012-068

**Distribution:**

Alexandra Drapack, Director Sustainable Development  
Cathryn Moffett, Project Manager Sustainable Development



## Hammond Reef Gold Project Conceptual Closure and Rehabilitation Plan



**Prepared by:** Rui Couto  
Geotechnical Engineer  
Golder Associates Ltd. Date: February 19, 2013



**Reviewed by:** Ken Bocking  
Principal, Senior Technical Reviewer  
Golder Associates Ltd. Date: February 19, 2013

## Table of Contents

<b>1.0 INTRODUCTION.....</b>	<b>1</b>
<b>2.0 BACKGROUND.....</b>	<b>5</b>
2.1 Mine Closure Objectives.....	5
2.2 Current Land Use .....	5
2.3 Conceptual Closure Measures .....	6
2.4 General Post-Closure Site Conditions.....	7
<b>3.0 PROGRESSIVE REHABILITATION.....</b>	<b>8</b>
<b>4.0 REHABILITATION MEASURES AT CLOSURE .....</b>	<b>9</b>
4.1 Project Site Infrastructure .....	9
4.2 Tailings Management Facility .....	13
4.3 Waste Rock Stockpile.....	14
4.4 Overburden Stockpile .....	15
4.5 Low-grade Ore Stockpile .....	15
4.6 Open Pits.....	16
4.7 Water Management at Closure.....	16
<b>5.0 POST-CLOSURE MONITORING .....</b>	<b>19</b>
5.1 Physical Stability.....	19
5.2 Chemical Stability .....	20
5.3 Biological Monitoring.....	24
5.3.1 Aquatic Monitoring Program.....	24
5.3.2 Terrestrial Monitoring Program .....	24
<b>6.0 EXPECTED SITE CONDITIONS AT CLOSURE .....</b>	<b>25</b>
6.1 Land Use .....	25
6.2 Post-closure Site Ownership .....	25
6.3 Site Topography .....	25
6.4 Surface and Groundwater Conditions.....	26
6.5 Terrestrial Flora and Fauna .....	26

6.6 Aquatic Flora and Fauna ..... 27

**7.0 LIST OF REFERENCES..... 29**

**8.0 GLOSSARY OF TERMS ..... 30**

**9.0 LIST OF ABBREVIATIONS, ACRONYMS AND INITIALISMS..... 31**

**10.0 LIST OF UNITS..... 32**

**TABLES**

Table 5-1: Hammond Reef Physical Stability Monitoring Frequencies at Closure..... 19

Table 5-2: Surface Water and Groundwater Sampling Requirements for Closure..... 22

Table 8-1: Glossary of Terms..... 30

Table 9-1: List of Abbreviations, Acronyms and Initialisms ..... 31

Table 10-1: List of Units ..... 32

**FIGURES**

Figure 1-1: Site Location Plan ..... 2

Figure 1-2: General Arrangement Plan ..... 3

Figure 1-3: General Arrangement Plan – Ore Processing Facility Area ..... 4

Figure 4-1: Expected Site Conditions at Year 1 of Closure ..... 10

Figure 4-2: Summary of Flows at Year 1 of Closure ..... 11

Figure 4-3: Summary of Flows for Long-term Closure ..... 12

Figure 4-4: Pit Flooding Model Results Climatic Conditions: Average Pit Seepage Rate: 750 m<sup>3</sup>/hr ..... 18

Figure 6-1: Expected Long-term Post-closure Site Conditions..... 28

**APPENDICES**

**APPENDIX 4.I**

Flow Model for Year 1 of Closure

**APPENDIX 4.II**

Flow Model for Long-term Post-closure

## 1.0 INTRODUCTION

Golder Associates Ltd. (Golder) has been retained by Osisko Hammond Reef Gold Ltd. (OHRG) to prepare a Conceptual Closure and Rehabilitation Plan for the purposes of the environmental assessment and permitting, and to facilitate Aboriginal consultation for the Hammond Reef Gold Project (Project). A summary of completed Aboriginal and public consultation throughout closure planning to date is provided in Chapter 7 of the EIS/EA Report for the Project.

The Project consists of the development of a gold deposit located within the Thunder Bay Mining District in north-western Ontario, approximately 170 kilometres (km) west of Thunder Bay and approximately 23 km northeast of the town of Atikokan, Ontario (Figure 1-1). Mining will be by open pit methods.

The Project consists of the following interrelated and key components:

- A mine, including two open pits (east pit and west pit) and a low-grade ore stockpile.
- A Waste Rock Management Facility (WRMF).
- An Ore Processing Facility, with a live ore stockpile.
- A Tailings Management Facility (TMF), including tailings disposal and reclaim water pipelines.
- Support and Ancillary Infrastructure (e.g., overburden stockpile, substation, truck shop, fuel storage).
- Water Management System, including an Effluent Treatment Plant (ETP).
- Linear Infrastructure (e.g., transmission line, access road (Hardtack/Sawbill)).
- Borrow Sites for aggregates.

Figure 1-2 provides a general arrangement of the Project Site during operations, while Figure 1-3 provides a close-up of the general arrangement of the Ore Processing Facility area. This report describes the Conceptual Closure and Rehabilitation Plan for the Project Site as it relates to the key Project components.

Per the requirements of Part VII of the Ontario *Mining Act* a Certified Closure Plan for the Project will also be submitted under separate cover to the Ministry of Northern Development and Mines (MNDM). The Certified Closure Plan will indicate the method, schedule, and cost of all rehabilitation to be conducted once closure commences. It will also form the basis for the provision of financial assurance for the Project.

This report is a Conceptual Closure and Rehabilitation Plan for environmental assessment purposes. The concepts presented herein will also form the basis of the Certified Closure Plan.



**REFERENCE**

Base Data - Provided by OSISKO Hammond Reef Gold Project Ltd.;  
 Base Data - MNR NRVIS, obtained 2004  
 Produced by Golder Associates Ltd under licence from Ontario Ministry of Natural Resources, © Queens Printer 2008  
 Projection: Transverse Mercator Datum: NAD 83 Coordinate System: UTM Zone 15N

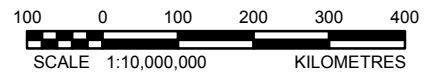

DATE	February 2013
DESIGN	JO
GIS	JO
CHECK	RC
REVIEW	KAB

TITLE	<b>SITE LOCATION PLAN</b>	
PROJECT		
FIGURE:	1-1	

PROJECT No. 10-1118-0020

SCALE AS SHOWN

VERSION 1



G:\Projects\2010\10-1118-0020\_BretlResources\_HammondReef\GIS\IMXD\Draft\EA\_Closure\ProjectComponents.mxd

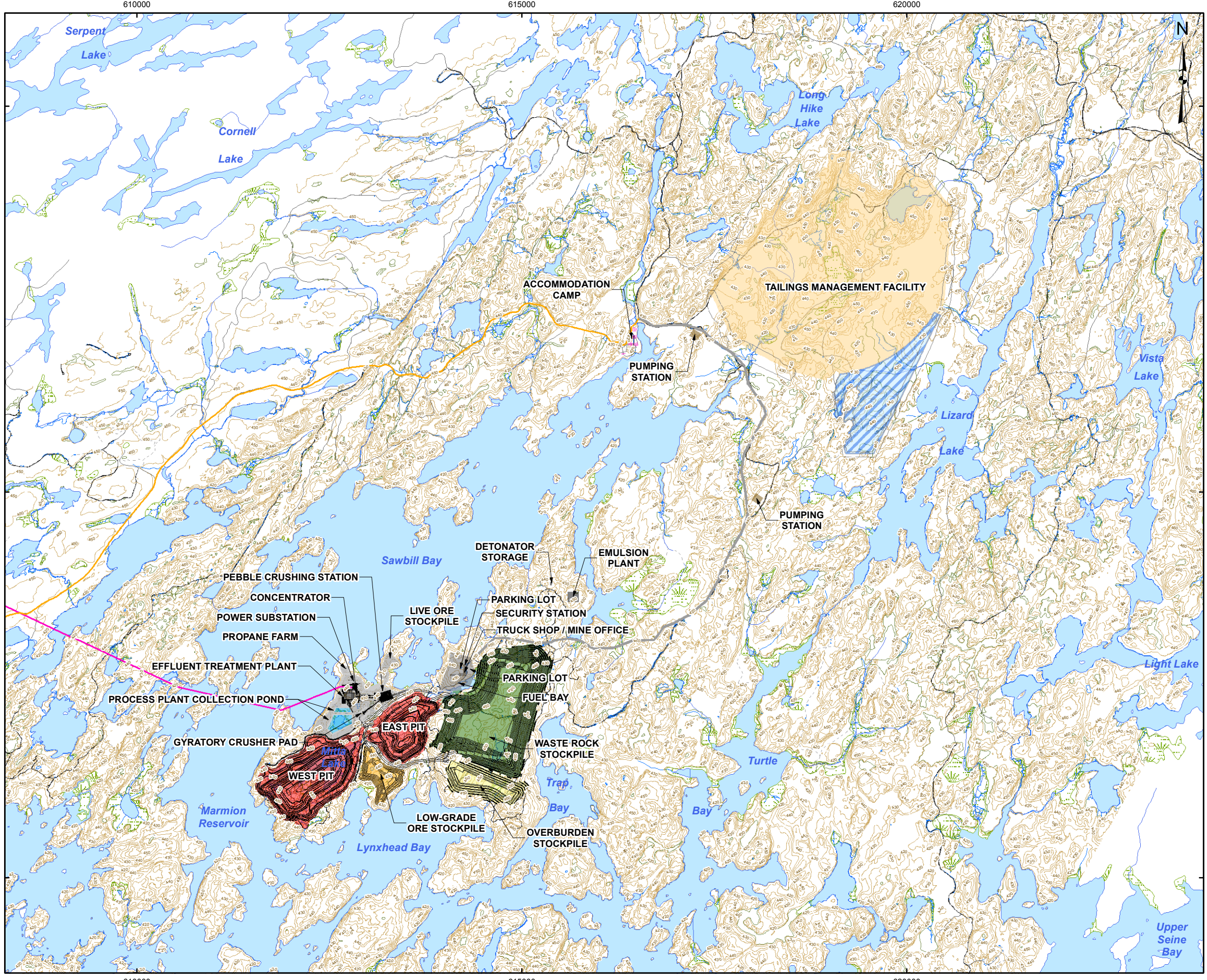

**LEGEND**

- Index Contour (5m interval)
- Ditch
- Marsh/Swamp
- River/Stream
- Road
- Trail
- Lake
- Wetland
- Mine Site Road
- Access Road (Hardtack / Sawbill)
- Project Transmission Line
- Accommodation Camp
- Laydown Area
- Office and Truck Shop, Explosives Storage and Processing Plant
- Open Pits
- Low-Grade Ore Stockpile
- Overburden Stockpile
- Process Plant Collection Pond
- Pumping Station
- Tailings Management Facility
- Tailings Management Facility Reclaim Pond
- Waste Rock Stockpile

**REFERENCE**

Base Data - Provided by OSISKO Hammond Reef Gold Project Ltd.  
 Base Data - MNR NRVIS, obtained 2004  
 Produced by Golder Associates Ltd under licence from  
 Ontario Ministry of Natural Resources, © Queens Printer 2008  
 Projection: Transverse Mercator Datum: NAD 83 Coordinate System: UTM Zone 15N

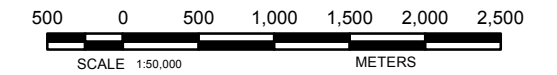

<b>PROJECT</b>	HAMMOND REEF GOLD PROJECT ATIKOKAN, ONTARIO, CANADA		
<b>TITLE</b>	<b>GENERAL ARRANGEMENT PLAN AT END OF OPERATIONS</b>		
 Golder Associates Mississauga, Ontario	PROJECT NO. 10-1118-0020	SCALE AS SHOWN	VERSION 1
	DESIGN CGE 14 Nov. 2008		
	GIS JO 4 Feb. 2013		
	CHECK RC 4 Feb. 2013 REVIEW KAB 4 Feb. 2013		
			FIGURE: 1-2

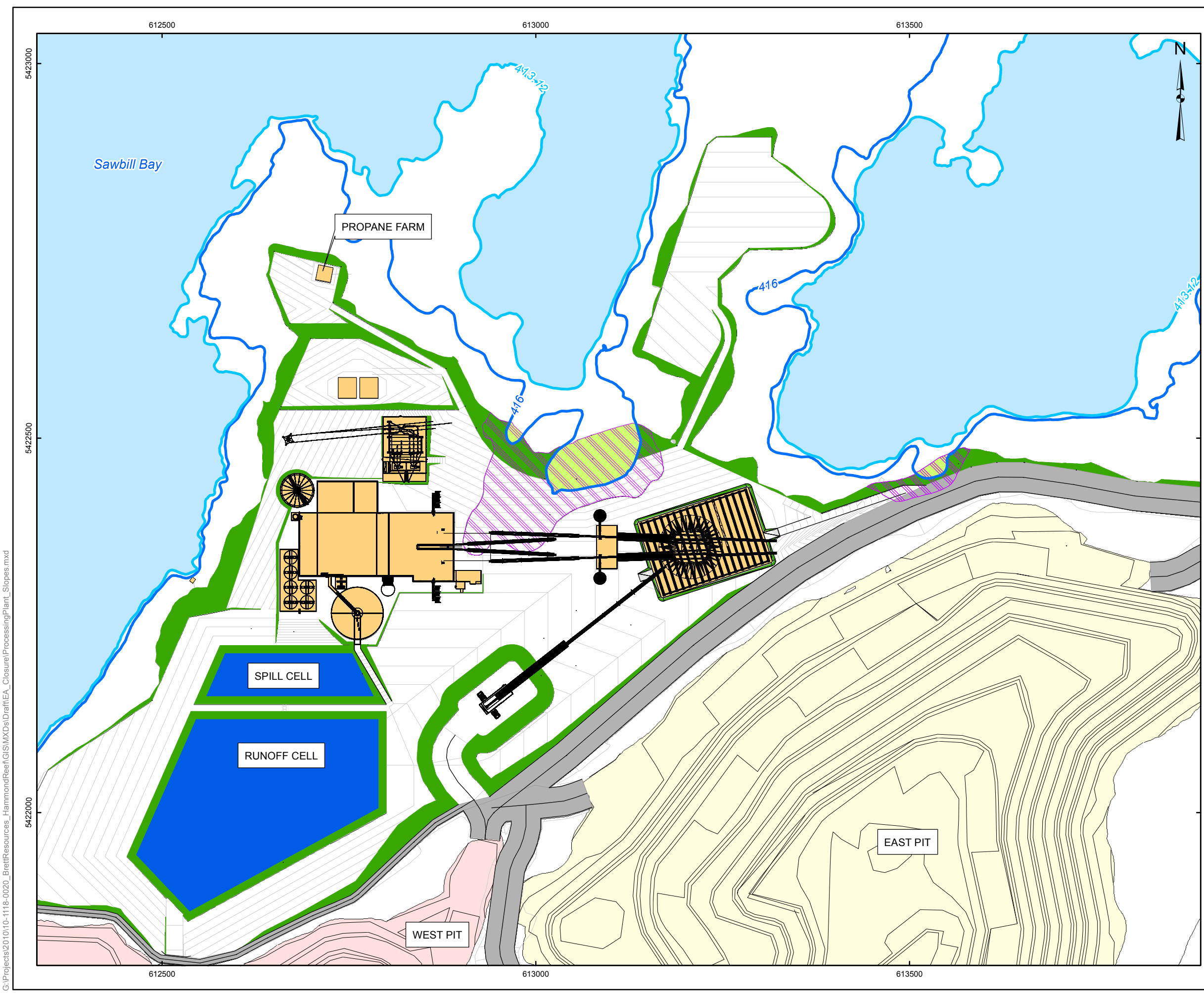

**LEGEND**

- Low Water Level (413.12m)
- Lake Maximum Water Level (416m)
- Road
- Process Plant Facilities
- Process Plant Collection Pond
- West Pit
- East Pit
- Clean Fill Requirement
- Fill Area Slope
- 2h: 1v Fill Below High Water Level (416m)
- Waterbody

**REFERENCE**

Base Data - Provided by Brett Resources  
 Base Data - MNR NRVIS, obtained 2004  
 Produced by Golder Associates Ltd under licence from  
 Ontario Ministry of Natural Resources, © Queens Printer 2008  
 Projection: Transverse Mercator Datum: NAD 83 Coordinate System: UTM Zone 15N



<b>PROJECT</b>	<b>HAMMOND REEF GOLD PROJECT ATIKOKAN, ONTARIO, CANADA</b>		
<b>TITLE</b>	<b>PROCESS PLANT</b>		
 <b>Golder Associates</b> <small>Mississauga, Ontario</small>	PROJECT NO. 10-1118-0020	SCALE AS SHOWN	VERSION 1
	DESIGN SR 14 Nov. 2008		
	GIS JO 4 Feb. 2013		
	CHECK CH 4 Feb. 2013		
REVIEW CH 4 Feb. 2013			<b>FIGURE: 1-3</b>

G:\Projects\2010\10-1118-0020\_BrettResources\_HammondReef\GIS\MXDs\Drath\EA\_Closure\ProcessingPlant\_Slopes.mxd

## **2.0 BACKGROUND**

### **2.1 Mine Closure Objectives**

The closure phase is the final phase of the Project following the construction and operation phases, and involves the removal of Project facilities and infrastructure which supported those activities. The overall objectives of this Conceptual Closure and Rehabilitation Plan are to outline how the affected land will be rehabilitated in an environmentally responsible way in order to:

- Prevent personal injury or property damage that is reasonably foreseeable as a result of closing out the Project.
- Restore the Project Site to its former use or an acceptable alternative use, to the extent possible.

The rehabilitation measures presented in this Conceptual Closure and Rehabilitation Plan follow the Mine Rehabilitation Code of Ontario, Schedule 1 of Ontario Regulation 240/00. The code provides specific standards, procedures, and minimum requirements for the closure of mines in Ontario.

This Conceptual Closure and Rehabilitation Plan is developed for the purposes of the environmental assessment and permitting and will be refined through the operations phase as additional information and monitoring results become available. Community feedback through ongoing public consultations will shape the evolution of the Conceptual Closure and Rehabilitation Plan and will help determine post-closure use of Project facilities and land use in the Project Site.

Regular monitoring of the physical, chemical, and biological stability of the remaining mine hazards and structures (e.g., the TMF, waste rock and overburden stockpiles, and open pits) is planned after closure to assess the effectiveness of the rehabilitation measures, as per the Mine Rehabilitation Code of Ontario.

The following sections of the report describe the current land use, the rehabilitation measures at closure (including opportunities for progressive rehabilitation), the post-closure monitoring requirements, and the expected post-closure conditions of the Project Site.

### **2.2 Current Land Use**

The Hammond Reef property and surrounding areas are covered by Ministry of Natural Resources (MNR) Crown Land Use Policy areas G2568 (Finlayson) and G2571 (Marmion). Existing uses in these areas are listed as: logging, mineral exploration, trapping, commercial bait fishing, aggregate extraction, angling, boating, canoeing, hunting, tourism and wild rice harvesting.

Policy Area G2571 specifically covers Upper Marmion Reservoir. The policy designates Upper Marmion Reservoir as a tourism area, recognizing it as an easily accessible and highly productive angling area for local residents and the tourism industry. Mining activities are also recognized as an intended land use. The reservoir is the source of cooling water for the Atikokan Electrical Generating Station. The discharge of the Upper Marmion Reservoir is also used to generate hydro power at three downstream Generating Stations (Valerie Falls, Calm Lake and Sturgeon Falls).

Policy area G2568 (Finlayson) covers a large area north and east of Atikokan and north of Highway 11. Designated tourism lakes include Lizard Lake, Finlayson Lake, Bradshaw Lake, Husband Lake and Light Lake. The primary land use intent is identified as timber production.

A fly-in fishing tourism operation is located within the Project Site. OHRG has a signed agreement with the potentially affected party to restrict access to certain areas to allow for mining practices to be undertaken in a safe manner.

### 2.3 Conceptual Closure Measures

The following describes the general closure measures and activities that will occur at the end of the Operations Phase. These closure activities, including any opportunities for progressive rehabilitation, are elaborated upon in the subsequent sections of this report.

At closure the following main activities will occur:

- On-site access and haul roads not required for post-closure monitoring and maintenance will be scarified and their associated culverts removed to restore natural drainage conditions.
- Borrow sites will be closed out according to their license under the Aggregate Resource Act (ARA).
- Project facilities (Ore Processing Facility, maintenance buildings, and other ancillary structures) will be demolished.
- The ETP and Ore Processing Facility Collection Pond (PPCP) will be decommissioned.
- The TMF will be re-vegetated and the water level in the reclaim water pond will be lowered and, once suitable water quality is achieved, run-off will be directed via a drainage channel towards Sawbill Bay.
- The tailings pipeline system will be dismantled and removed off-site.
- The top surface of the waste rock stockpile will be graded to help shed runoff and reduce infiltration. Drainage measures (i.e., chute drains and grading of benches) will be put in place to safely convey runoff to the toe of the waste rock stockpile, and suitable erosion protection will be provided. The individual seepage collection ponds will be decommissioned once water quality is deemed suitable for direct discharge to the environment.
- The top surface of the overburden stockpile will be re-graded to shed run-off and reduce infiltration. Drainage measures (i.e., chute drains and grading of benches) will be put in place to safely convey runoff to the toe of the overburden stockpile, and suitable erosion protection will be provided. The overburden stockpile will be seeded and re-vegetated. The individual seepage collection ponds will be decommissioned once water quality is deemed suitable for direct discharge to the environment.
- The low-grade ore stockpile will be processed before decommissioning and demolition of the Ore Processing Facility. The area will be allowed to naturally re-vegetate and the seepage collection ponds will be decommissioned once water quality is deemed suitable for direct discharge to the environment.
- The open pit sumps will be removed and the pits will be allowed to flood. A rock barrier will be constructed around the pit perimeter to prevent inadvertent access.

- A channel will be constructed between the east and west pits to hydraulically connect both pits. A discharge channel will be constructed between the west pit and the Marmion Reservoir (near the location of the operational ETP discharge).
- All fuels, oils, reagents, explosives, and hazardous substances will be removed off site and their containment structures / facilities decommissioned and demolished.
- Any unsalvageable / un-recyclable non-hazardous waste will be disposed of in a licensed landfill within the TMF.
- On site transmission lines will be removed once pumping of water is no longer required (i.e. upon decommissioning of the seepage collection ponds).

## 2.4 General Post-Closure Site Conditions

At final closure, relative to the pre-development conditions, the principal topographic changes to the Project Site will include the following:

- The TMF, raised in a conical shape formation approximately 63 m in elevation from the central discharge point to the lowest existing elevation surrounding the facility, with the tailings sloped at 3%.
- The Ore Processing Facility Area will have been raised about 25 m above the previously existing ground surface.
- A waste rock stockpile rising about 160 m above existing ground and with an overall slope of 2.5H:1V.
- A re-vegetated overburden stockpile rising about 60 m above existing ground and an overall slope of 3H:1V.
- Two open pits, flooded to an elevation of 420 m, with the spillover point at the west end of the west pit (near the planned operational discharge point).
- Runoff and seepage collection ponds (to be decommissioned once water quality is acceptable for environmental discharge).
- A few on-site roads to allow access for post-closure monitoring.

Aside from a few buildings and infrastructure elements which will remain temporarily after closure for water management purposes, most of the Project Site (excluding the waste rock stockpile and the open pits) will largely be reclaimed and re-vegetated.

### **3.0 PROGRESSIVE REHABILITATION**

Progressive rehabilitation will be undertaken during mining operations to the extent that it is practicable to do so. Because of the nature of the operations, the opportunities for progressive rehabilitation of the Project Site are relatively limited, except during the final year or two of the operations phase.

Due to the stacked conical nature of the tailings impoundment and the rotating discharge of the tailings from a central discharge point, progressive reclamation of the tailings surface, in the form of re-vegetation, will likely commence about one year prior to closure. During operations, the tailings will be tested to determine what nutrients are lacking and then the surface will be seeded and fertilized. It may also be advantageous to apply organic mulch, such as pulp mill sludge. Details of the re-vegetation (i.e., seed mixture, fertilizer, mulch) will be verified prior to closure using test plots on inactive parts of the TMF surface.

An emergency spillway and drainage channel will be constructed at the west end of the Reclaim Pond Dam during years of operations, to divert discharge from extreme storm event westwards into Sawbill Bay in order to prevent dam overtopping. This spillway and drainage channel will remain at closure to convey run-off from the TMF watershed into Sawbill Bay. The spillway will be lowered from an elevation of 444 m to 442 m at closure to reduce the Reclaim Pond storage volume.

The majority of the borrow sites will be rehabilitated upon completion of construction, except for those areas that will be retained to supply material for maintenance purposes. Progressive rehabilitation will adhere to the terms of the license under the *Aggregate Resources Act* (ARA). In general, progressive rehabilitation should be designed to incorporate the following criteria:

- Adequate drainage and vegetation.
- A re-vegetation plan that uses topsoil or overburden from initial stripping.
- Adequate maximum slopes of the excavation faces (no steeper than 3H:1V).

## **4.0 REHABILITATION MEASURES AT CLOSURE**

The following sections outline the rehabilitation measures to be completed throughout the closure phase of the Project. Figure 4-1 provides a snapshot of the Project Site at Year 1 of closure. Appendix 4.I provides the water balance for the Project Site at Year 1 of closure, while Appendix 4.II provides the long-term post-closure water balance for the Project Site, once the open pit has flooded. Summaries of the site wide flows arising from the water balances are provided in Figures 4-2 and 4-3 for the Year 1 and long-term scenarios, respectively.

### **4.1 Project Site Infrastructure**

On-site roads will be maintained after closure only to the extent they are required to provide access for monitoring and maintenance activities. This includes access to all remaining dams and to active water conveyance structures (i.e., spillways, ditches, remaining pump stations, etc.). Any redundant on-site roads will be scarified, and culverts will be removed to restore natural drainage conditions.

The existing access road (Hardtack/Sawbill) is the property of the Ministry of Natural Resources (MNR). It will be improved and used by OHRG under the terms of a separate agreement. OHRG will continue to use the access road after closure for the purpose of monitoring and maintenance. Such use will follow the terms outlined in the separate agreement.

Any borrow site remaining in operation at the time of closure will be closed out according to the licence under the *Aggregate Resources Act*.

The Project transmission line will become redundant after the completion of Project closure measures, including the cessation of pumping of tailings water and stockpile seepage (see Sections 4.2 to 4.5). It may be transferred to another party; or alternatively, it will be taken down and the cables and poles will be salvaged.

The Project facilities (e.g., the processing plant and equipment, the maintenance shops, the accommodation camp, etc.) will be redundant after closure. Portable facilities such as trailers will be removed from the Project Site. Permanent facilities will be decommissioned and demolished. Materials will be salvaged or sold as scrap to the extent possible. Non-hazardous demolition waste will be disposed of in a solid waste landfill to be licensed within the TMF. Any hazardous materials or liquid wastes will be removed from the Project Site for management and disposal in accordance with applicable legislation. Any soils impacted by hydrocarbons will be either bio-remediated on-site or shipped to a licensed facility.

At closure, a portion of the graded slope along the north side of the former Ore Processing Facility area will be periodically submerged during high tide. Therefore, some erosion due to wave action may occur. It is assumed that the slopes will be lined with rockfill or rip-rap during the construction phase to prevent significant erosion. The slopes will be monitored during the post-closure phase for stability and erosion as described in Section 5.1 of this report.

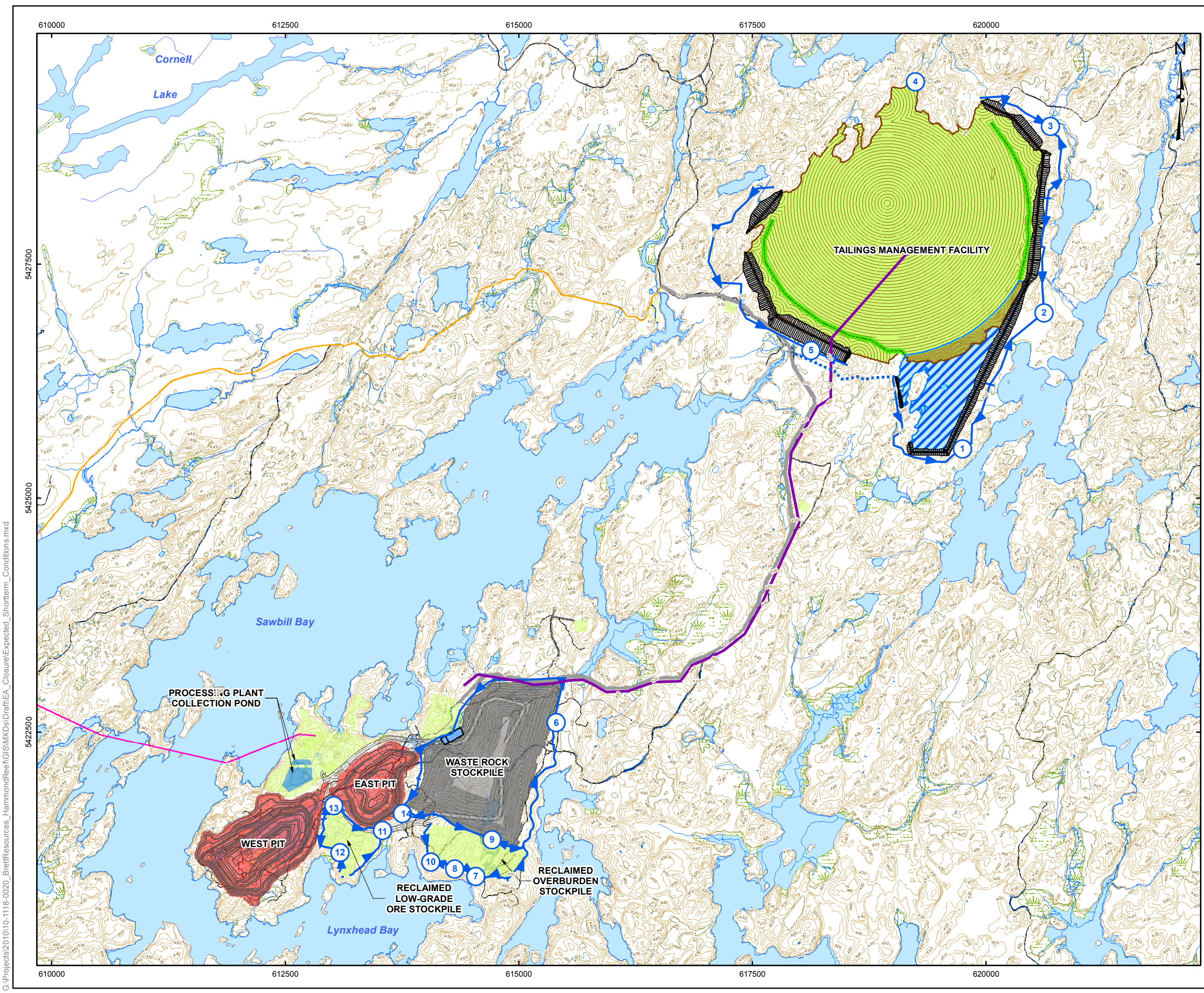

**LEGEND**

- Topographic Contour (5m interval)
- Ditch
- Marsh/Swamp
- River/Stream
- Road
- Trail
- Lake
- Wetland
- Pumping Station
- Proposed Ditch
- Tailings Drainage Channel Alignment
- Erosion Protected Channel
- Mine Site Road
- Access Road (Hardtack / Sawbill)
- Project Transmission Line
- Tailings Pipeline Alignment
- Intermediate Collection Pond
- Partially Revegetated Surface
- Processing Plant Collection Pond / Emergency Spill Pond
- Waste Rock Stockpile
- Open Pit
- Tailings Management Facility Dam
- Tailings Management Facility Reclaim Pond

- NOTES**
1. Pumping from Tailings Management Facility Pond to Open Pits continues until water quality is acceptable for discharge to Sawbill Bay.
  2. Pumping from seepage collection pond continues until water quality in individual pond is acceptable for discharge.

**REFERENCE**

Base Data - Provided by OSISKO Hammond Reef Gold Project Ltd.  
 Base Data - MNR NRVIS, obtained 2004  
 Produced by Golder Associates Ltd under licence from  
 Ontario Ministry of Natural Resources, © Queens Printer 2008  
 Projection: Transverse Mercator Datum: NAD 83 Coordinate System: UTM Zone 15N

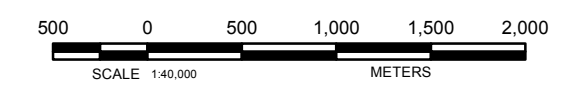

<b>PROJECT</b>	HAMMOND REEF GOLD PROJECT ATIKOKAN, ONTARIO, CANADA		
<b>TITLE</b>	<b>EXPECTED SITE CONDITIONS AT YEAR 1 OF CLOSURE</b>		
	PROJECT NO. 10-1118-0020	SCALE AS SHOWN	VERSION 1
	DESIGN CGE 14 Nov. 2008		
	GIS JO 4 Feb. 2013		
	CHECK RC 4 Feb. 2013		
REVIEW KAB 4 Feb. 2013			<b>FIGURE: 4-1</b>

G:\Projects\2010\10-1118-0020\_BrettResources\_HammondReef\GIS\MXDs\Drawn\EA\_Closure\Expected\_Shortterm\_Conditions.mxd



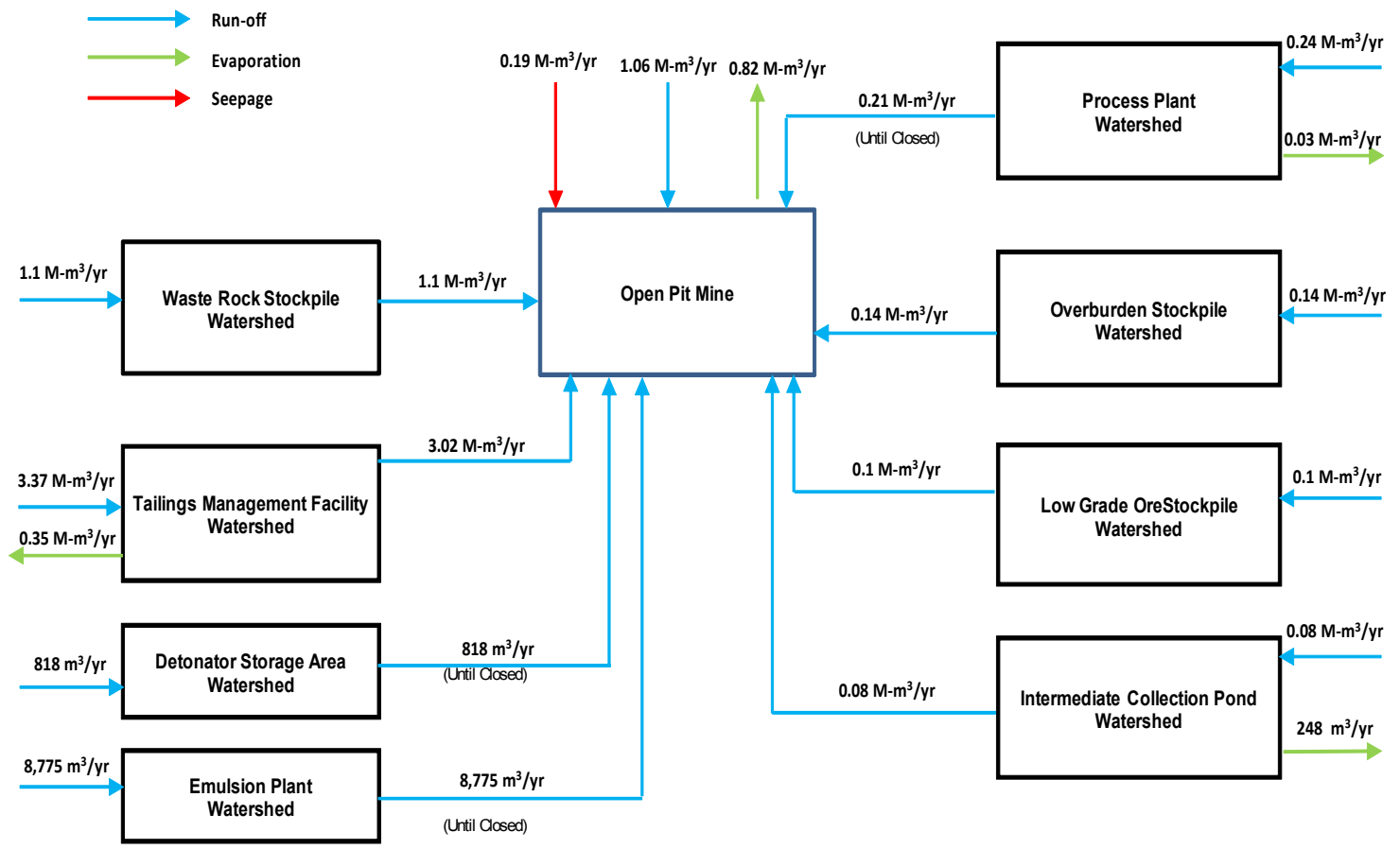



PROJECT		HAMMOND REEF GOLD PROJECT ATIKOKAN, ONTARIO, CANADA	
TITLE		SUMMARY OF FLOWS AT YEAR 1 OF CLOSURE	
 Golder Associates Mississauga, Ontario	PROJECT NO.	10-1118-0020	
	DESIGN	CGE	24 May, 2012
	GIS	JO	4 Feb. 2013
	CHECK	RC	4 Feb. 2013
	REVIEW	KAB	4 Feb. 2013
			VERSION 1

**FIGURE: 4-2**

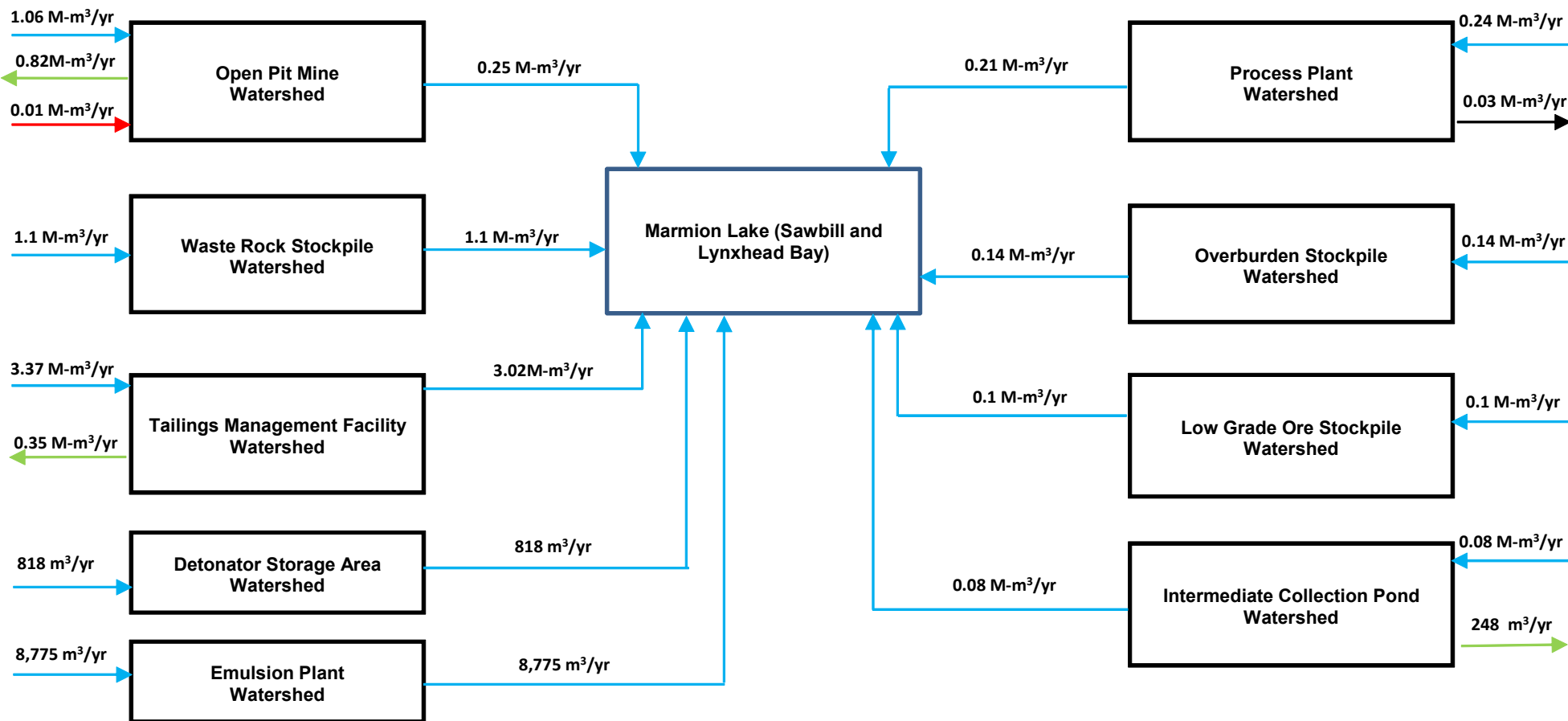
- Run-off
- Evaporation
- Seepage



PROJECT		HAMMOND REEF GOLD PROJECT ATIKOKAN, ONTARIO, CANADA	
TITLE		SUMMARY OF FLOWS FOR LONG-TERM CLOSURE	
 Golder Associates Mississauga, Ontario	PROJECT NO.	10-1118-0020	
	DESIGN	CGE	24 May, 2012
	GIS	JO	4 Feb. 2013
	CHECK	RC	4 Feb. 2013
	REVIEW	KAB	4 Feb. 2013
			VERSION 1

**FIGURE: 4-3**

## **4.2 Tailings Management Facility**

At the end of operations, the TMF will contain about 231 million tonnes (Mt) of tailings. Thickened tailings will be delivered to the TMF through a tailings disposal pipeline and pumping system installed between the Ore Processing Facility and the TMF along the mine site road alignment. The deposition plan for the thickened tailings will result in a flat conical surface with slopes of about 3%. The TMF will include a reclaim water pond impounded along its southeastern limit. A reclaim water pump and pipeline system will allow water to be pumped from the reclaim pond to the Processing Plant Collection Pond (PPCP), where it will either be reused or treated and released. Seepage collection ponds (shown as pumping stations in Figure 4-1) will be located at the low points along the downstream toes of the TMF dams. Water collected in these ponds during operations will be tested and released if of acceptable quality, or pumped back into the TMF if the water quality is not acceptable. Geochemically, the tailings are expected to be relatively benign and are not expected to generate acidic drainage.

After closure, the inactive tailings beaches are expected to be susceptible to erosion by surface runoff, and exposed tailings surfaces could also generate off-site migration of dust.

The closure measures are designed to physically stabilize the tailings surfaces to prevent erosion and dust generation. Because they are non-acid generating, it should be practicable to re-vegetate the tailings surface directly, without the requirement to place a layer of topsoil.

During operations, the tailings surfaces will be tested to determine what nutrients are lacking. It may be advantageous to apply organic mulch, such as pulp mill sludge. Details of the re-vegetation (i.e., seed mixture, fertilizer, mulch) will be verified prior to closure using test plots on inactive parts of the TMF surface. At closure, the entire exposed tailings surfaces will be re-vegetated following the developed procedures. It is expected that runoff from the re-vegetated tailings surfaces will concentrate in certain areas in response to the final topography of the TMF. Appropriate erosion protection ditches will be applied in such areas to prevent possible gully formation (Figure 4-1).

The OHRG tailings dams were designed as permanent impoundment structure, according to Canadian Dam Association (CDA) Guidelines and Ontario MNR Guidelines. The design of the OHRG tailings dam was completed by Golder Associates and will be peer reviewed by an independent expert in tailings dam construction and operation.

In addition, the Mining Association of Canada (MAC) provides guidelines for best practices for management of tailings dams. OHRG intends to develop a customized tailings management system that address the specific needs of OHRG, local regulatory and community requirements. The management system will include:

- A framework for tailings management.
- Sample checklists for implementing the framework through the life cycle of a tailings facility.

The framework will offer a foundation for managing tailings in a safe and environmentally responsible manner through the full life cycle of a tailings facility from site selection and design, through construction and operation, to eventual decommissioning and closure.

The tailings management framework will be expanded into checklists that address the various stages of the life cycle. These checklists will provide a basis for developing a customized management system, operating procedures and manuals, exposing gaps within existing procedures, identifying training requirements,

communicating with Communities of Interest, obtaining permits, conducting internal audits, and aiding compliance and due diligence, at any stage of the life cycle.

Water in the seepage collection ponds will continue to be monitored after closure. The water in these ponds will continue to be pumped back into the TMF Reclaim Pond until such time as the water quality in the individual ponds becomes acceptable for direct discharge. When water quality is shown to consistently meet acceptable discharge levels, individual seepage pond dykes will be breached and their pumping systems will be removed.

Initially after closure, the tailings disposal pipeline and pumping system will be decommissioned; however the reclaim water pipeline will continue to be used to transfer runoff from the TMF Reclaim Pond to the open pits to (Figure 4-1); until such time that the run-off water quality from the TMF becomes suitable for direct discharge to the environment. Post-closure water management is discussed further in Section 4.7.

The water quality in the TMF reclaim pond is expected to improve after closure (Golder 2013a). Suspended solids will also drop as the tailings surface is re-vegetated. When the water quality in the reclaim pond improves sufficiently, the former emergency spillway will be lowered and runoff will be conveyed from the TMF reclaim pond eastward toward Sawbill Bay. At that point, pumping and treatment of water from the TMF will cease and the reclaim water pump and pipeline system will be decommissioned. A certain amount of pond volume will be permanently retained below the invert level of the closure spillway (estimated at about elevation 440 masl).

### **4.3 Waste Rock Stockpile**

Mine development will generate approximately 250 Mt of waste rock over the life of mine to be stockpiled east of the east pit. About 19.5 Mt is expected to be used for construction of the TMF dams, and 16 Mt of waste rock will be deposited in the west pit in the later stages of mining. This rock will be submerged as the open pits flood. The remaining waste rock will remain in the waste rock stockpile. The waste rock stockpile has been designed with conservative side slopes (i.e., overall slope of approximately 2.5 (H:V) with 1.5 (H:V) inter-bench slopes and 12.25 metres (m) wide benches spaced every 10 m vertically). The maximum height of the waste rock stockpile will be about 156 m. This slope design should provide for long-term stability of the waste rock stockpile slopes.

Seepage collection ponds (shown as pumping stations on Figure 4-1) will be located downstream of the toe of the waste rock stockpile at four locations. During operations, water collected in these ponds can be tested and released directly to the environment if it is of acceptable quality. If the water quality is not acceptable, the water will be pumped to the PPCP from where it will either be reused in the process or treated and released.

Waste rock will comprise hard rock fragments (i.e., not weathered material) that will be resistant to breakdown or erosion. At closure, the top surface of the waste rock stockpile will be graded to help shed runoff and reduce infiltration. Drainage measures (i.e., chute drains and grading of benches) will be put in place to safely convey runoff to the toe of the waste rock stockpile, and suitable erosion protection will be provided. The waste rock is not expected to generate acidic runoff. Therefore, placement of a soil cover over the surface of the waste rock stockpile is not proposed. The waste rock stockpile will be physically stable without vegetation, so no active re-vegetation is proposed.

Water in the four seepage collection sumps/ponds will continue to be monitored after closure. The water in these ponds will be pumped to the open pits to accelerate the backflooding process, until such time as the water

quality in the individual ponds becomes acceptable for direct discharge. When that occurs consistently, individual seepage pond dykes will be breached and their pumping systems will be removed.

#### **4.4 Overburden Stockpile**

During operations, overburden stripped from the open pits will be deposited in a stockpile to be located south of the waste rock stockpile. Overburden will be placed in a physically stable configuration and has been designed with 2H:1V side slopes, with a bench width of 10 m, for an overall slope of about 3H:1V and an overall height of about 60 m. Seepage collection ponds (pumping stations) will be located downstream of the toe of the overburden stockpile at three locations. During operations, water collected in these ponds will be tested and released if it is of acceptable quality. If the water quality is not acceptable, water will be pumped to the PPCP from where it will either be reused in the processing plant or treated and released. Overburden is expected to be geochemically benign; however it will generate suspended solids until vegetation is established across the overburden stockpile.

At closure, some of the overburden may be used for re-grading throughout the Project Site to facilitate closure. The top surface of the remaining material in the overburden stockpile will be graded to help shed runoff and reduce infiltration. Drainage measures (i.e., chute drains and grading of benches) will be put in place to safely convey runoff to the toe of the overburden stockpile, and suitable erosion protection will be provided.

Overburden is expected to be geochemically benign and will be able to support vegetation. Therefore, placement of a soil cover over the surface of the overburden stockpile is not proposed; rather the surface will be directly re-vegetated once other areas within the Project Site requiring overburden have been reclaimed.

Water in the four overburden stockpile seepage collection ponds will continue to be monitored after closure. The water in these ponds will continue to be pumped to the open pits until such time as the water quality in the individual ponds becomes acceptable for direct discharge. When that occurs consistently, individual seepage pond dykes will be breached and their pumping systems will be removed.

#### **4.5 Low-grade Ore Stockpile**

During operations, low-grade ore will be stored separately in a stockpile located south of the east pit. Seepage collection ponds (pumping stations) will be located downstream of the toe of the low-grade ore stockpile at three locations. During operations, water collected in these ponds will be tested and released if it is of acceptable quality. If the water quality is not acceptable, the water will be pumped to the PPCP from where it will either be reused in the process or treated and released.

It is expected that the material in the low-grade ore stockpile will be milled as ore during the operating phase of the Project. In such a case, no closure measures will be required. The seepage collection ponds and pumps would be decommissioned when the low-grade ore stockpile is fully processed, and the area will be allowed to naturally re-vegetate. If on the other hand, some of the low-grade ore stockpile remains at closure, it will be closed in the same manner as the waste rock stockpile. In such a case, water in the three seepage collection ponds would continue to be monitored after closure. Water in these ponds would continue to be pumped to the open pits until such time as the water quality in the individual ponds becomes acceptable for direct discharge.

When that occurs consistently, individual seepage pond dykes would be breached and their pumping systems would be removed.

## 4.6 Open Pits

At the end of the operations phase of the Project, pumping of water out of the open pits will cease and the open pits will slowly fill with water. Backflooding of the open pits is generally beneficial in several respects:

- After the open pits are flooded, steep slopes below the water level are no longer a safety hazard.
- Ponding reduces hydraulic gradients towards the pit faces, thus increasing their physical stability.

Without any contribution from TMF runoff, preliminary modelling indicates that it will take about 78 years for the water level in the open pits to rise to an elevation of 420 masl at which time the flooded open pits will begin to overflow near the location of the operational water discharge. Figure 4-4 graphically summarizes the pit flow modelling results.

At closure, a rock cut channel will be excavated between the east and west pits to hydraulically connect both pits. In addition, a rock cut channel will be excavated at the western perimeter of the west pit to direct the overflow from both pits into Upper Marmion Reservoir.

A rock barrier wall will be constructed around the perimeter of the open pits, using rock from the waste rock stockpile to prevent inadvertent access by the public to any slopes. The waste rock stockpile should provide a natural barrier along the east end of the East Pit. Just prior to closure, a rock mechanics evaluation of the open pit slopes will be carried out. If any unstable areas are identified, then “safe lines” will be established. The rock wall will be located outside of any safe lines.

## 4.7 Water Management at Closure

Appendices 4.I and 4.II provide the flow balance models for Year 1 of closure and for the post-closure scenario once the open pits have flooded, respectively. For a year or two after closure, (until such time that the TMF water quality is deemed suitable for direct discharge into Sawbill Bay), water will continue to be pumped from the TMF Reclaim Pond; however pumping of this water to the PPCP will cease upon closure and instead the reclaim water will be discharged into the open pits. Similarly, water pumped from the seepage collection ponds around the toes of the waste rock stockpile, the low-grade ore stockpile (if it still exists) and the overburden stockpile, will be pumped into the open pits rather than to the PPCP.

Once the processing plant and other Project infrastructure are demolished and the Project Site is re-vegetated, the remaining runoff reporting to the PPCP is not anticipated to require treatment. At that time, the PPCP and the ETP will be decommissioned, the perimeter dykes will be breached and normal runoff flow directions will be restored.

About 78 years after the operations phase is complete, the water in the flooded open pits will begin to overflow, and this overflow will be directed through a ditch into Upper Marmion Reservoir (Figure 4-4). Based on the post-closure flow model, it is estimated that about 253,000 m<sup>3</sup>/yr will overflow from the flooded open pits. After pit flooding is sufficiently advanced and prior to pit overflow, the water quality at the top of the flooded open pits will

be evaluated, and a decision will be made regarding post-overflow treatment if required. It is expected that stratification of water in the flooded open pits will result in surficial water quality that is suitable for discharge to Upper Marmion Reservoir. However, if stratification of the water does not produce acceptable water quality, additional treatment options will be considered at that time.

G:\Projects\2010\10-1118-0020\_BriefResources\_HammondReef\GIS\MMXD\Draft\EA\_Closure\PitFloodingModelResults.mxd

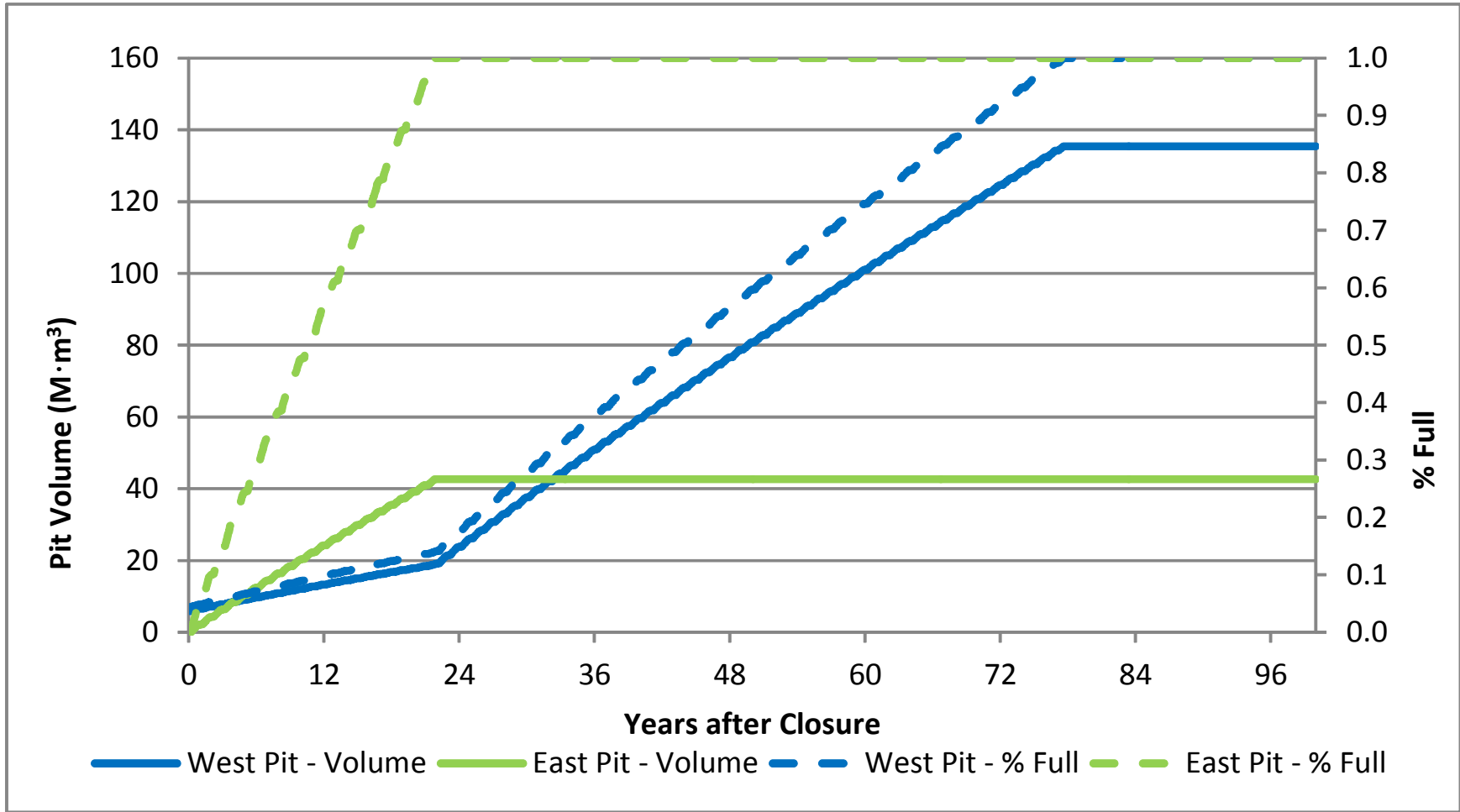

**NOTES**

1. Upon overflow, the West Pit will discharge through a spillway with an invert of approximately 420m into Marmion Reservoir.
2. Upon overflow, the East Pit will discharge through a channel with an invert of approximately 420m into the West Pit.

PROJECT		HAMMOND REEF GOLD PROJECT ATIKOKAN, ONTARIO, CANADA	
TITLE		PIT FLOODING MODEL RESULTS CLIMATIC CONDITIONS: AVERAGE PIT SEEPAGE RATE: 750 m <sup>3</sup> / h	
 Golder Associates Mississauga, Ontario	PROJECT NO. 10-1118-0020	VERSION 1	<b>FIGURE: 4-4</b>
	DESIGN CGE 24 May, 2012		
	GIS JO 4 Feb. 2013		
	CHECK RC 4 Feb. 2013		
REVIEW KAB 4 Feb. 2013			



## 5.0 POST-CLOSURE MONITORING

Monitoring for physical, chemical, and biological stability of the Project Site is planned for the post-closure phase of the Project. Monitoring will continue on a regular basis, as outlined in the sections below, per the Mine Rehabilitation Code of Ontario.

The monitoring programs are briefly described below. The Certified Closure Plan to be submitted to MNDM will provide more details with respect to specific monitoring locations, parameters, and frequencies, and how the results of the monitoring will be recorded and reported to the Director for the various states of closure (Temporary Suspension, State of Inactivity, and Permanent Closure). The Certified Closure Plan will also describe conditions under which the monitoring program will be scaled back or discontinued after closure.

### 5.1 Physical Stability

All mine-related structures and workings remaining in place at the Project Site at closure shall be monitored for physical stability. These will include:

- The open pit slopes above the water level.
- The waste rock and overburden stockpiles.
- The slopes of elevated area around the Ore Processing Facility.
- The low-grade ore stockpile (if it still exists).
- The tailings dams.
- Water management structures remaining in place at closure.

Table 5-1 below summarizes the physical stability monitoring requirements and frequency at closure.

**Table 5-1: Hammond Reef Physical Stability Monitoring Frequencies at Closure**

Monitored Item	Closure	
	Years 1-5	After Year 5
<b>Tailings Management Facility</b>		
General facility inspections	Annually	Annually
Tailings dam inspections (by site personnel)	Monthly	Annually
Tailings dam inspections (by geotechnical engineer)	Annually <sup>1</sup>	Annually <sup>1</sup>
Water levels, pipelines, pumping systems	Daily if pumping; monthly if discharging water by gravity flow <sup>2</sup>	Annually (where pumping is not required) <sup>2</sup>
Spillway / Drainage Channel	Monthly <sup>3</sup>	Monthly <sup>3</sup>
<b>Open Pit Stability and Water Levels</b>	Annually	Every 5 years
<b>Stockpiles</b>	Annually	Every 5 years
<b>Processing Facility Area Re-graded Slopes</b>	Annually	Every 5 years
<b>Reporting</b>	Annually	As per inspection

Notes: 1. Frequency of the dam inspection refers to an inspection by a qualified geotechnical engineer.

2. Inspection after closure only refers to the TMF Reclaim Pond levels and seepage collection ditches

3. Monthly during the ice-free season plus once prior to the spring freshet

For the first 5 years following the completion of all closure activities, the site will be visually inspected on a regular basis. While pumping is ongoing, maintenance personnel will inspect those systems on a daily basis. Once pumping ceases and water discharge is on a gravity basis, the inspection frequency will drop to monthly. The inspections and cleaning of water conveyance structures will be carried out monthly during the ice-free period, with an additional inspection just prior to the spring freshet.

It is expected that some site maintenance will be required after closure. Maintenance measures will include: ongoing removal of debris (such as beaver dams) from drainage channels and spillways, and removal of trees from the slopes of the permanent TMF dams. The site will also be inspected annually by a geotechnical engineer to assess physical stability and the potential for hazards. This will include annual inspections of the TMF dams, the waste rock and overburden stockpiles, and the open pit slopes.

The long-term monitoring program will be initiated at the end of 5 years, or once pumping from the reclaim pond to the open pits is no longer required, whichever comes last. The long-term monitoring plan also provides for a minimum monthly inspection of the Reclaim Pond spillway during the ice-free season with another inspection prior to the spring freshet. The annual inspection by the geotechnical engineer will continue. An inspection of the open pit slopes and waste stockpiles will be carried out at least once every 5 years.

An annual report will be prepared to document the inspections, noting any physical stability concerns observed during the calendar year, and detailing any corrective actions taken, will be prepared and forwarded to the Director, or his or her designate.

In addition to the foregoing, special inspections of the TMF will be carried out immediately in response to heavy runoff events or significant seismic events. In the case of runoff events, suitable trigger events will include a precipitation event or a rainfall - snowmelt event with a return period greater than 200 years. In the case of a seismic event, a maximum horizontal earthquake acceleration (MHEA) greater than 0.075 g would be an appropriate trigger.

## 5.2 Chemical Stability

To ensure environmental protection of receiving waters surrounding the mine site, a water quality monitoring program will be established considering upstream and downstream locations, to monitor both surface water and groundwater, as well as the flooded open pits water quality. The ETP will be decommissioned shortly after closure, once diversion of run-off to the open pits is completed. During any brief period that the ETP continues to operate after closure, its effluent will continue to be monitored in accordance with Ontario Regulation 560/94 and any Environmental Compliance Approval (ECA, formerly Certificate of Approval [C of A]) requirements. This monitoring will cease once the ETP is decommissioned. Once all flow is directed into the open pits, there will be no effluent leaving the site until one of the following occurs:

- The open pits overflow.
- The run-off from the TMF reclaim pond is redirected into Sawbill Bay.
- One or more of the seepage collection stations is decommissioned.

The proposed monitoring program for surface water leaving the site is summarized below. Laboratory detection limits will be below Provincial Water Quality Objectives (PWQOs). Analyses will be performed at an accredited laboratory. All other monitoring will be as laid out in the Certified Closure Plan, and is briefly described below.

Sampling locations for surface water and groundwater will include:

- Surface Water:
  - Open pit effluent point, from the overflow ditch, before discharge to Upper Marmion Reservoir (starting once overflow occurs).
  - The discharge point from the TMF Reclaim Pond into Sawbill Bay.
  - The various seepage collection low-points surrounding the TMF, until such time as they are decommissioned.
  - The various seepage collection low-points along the waste rock and overburden stockpiles, until such time as they are decommissioned.
  - Ponded water in the open pits.
  - Upstream and downstream site locations (includes Sawbill Bay, Lizard Lake, and Lynxhead Bay)
- Groundwater:
  - Upgradient and downgradient of the TMF.
  - Upgradient and downgradient of the waste rock and overburden stockpiles.

Sampling at all the locations will be initiated prior to closure (or carried over from the operations phase). The pre-closure data will be used to establish the background averages and temporal variations in the parameter concentrations, sufficient to define impacts on the groundwater and receiving surface waters should they occur.

As a minimum, water quality for both surface and groundwater will be monitored according to the parameters listed in O.Reg. 240/00. The ECA will cease when treatment ceases.

- pH.
- Conductivity.
- Total suspended solids.
- Total dissolved solids.
- Alkalinity.
- Acidity.
- Hardness.
- Cyanide.
- Ammonium.

- Sulphate.
- Aluminum (Al).
- Arsenic (As).
- Cadmium (Cd).
- Calcium (Ca).
- Copper (Cu).
- Iron (Fe).
- Lead (Pb).
- Mercury (Hg).
- Molybdenum (Mo).
- Nickel (Ni).
- Zinc (Zn).

It is proposed that a minimum five-year post-closure water quality monitoring program be initiated. A five-year monitoring program can also be applied to monitoring of the open pit overflow once the pits have flooded. After the five-year period, if the water quality warrants, and application will be made to the MNM to either:

- Reduce sampling frequency.
- Reduce monitoring parameters and/or cessation of the monitoring program altogether.

An annual monitoring report, summarizing the results of the surface and groundwater quality monitoring, detailing all compliances and exceedance, will be prepared and forwarded to the Director or his or her designate. Table 5-2 below provides the preliminary proposed sampling frequencies for closure and the conditions for change in frequency or discontinuation.

**Table 5-2: Surface Water and Groundwater Sampling Requirements for Closure**

Sample Locations	Parameters and Frequency				Condition for Change in Frequency or Discontinuation
	Monthly	Quarterly	Twice Annually	Annual	
<b>Surface Water</b>					
<b>First Year After Closure</b>					
Ponded water in Open Pit			Group A <sup>1</sup>		Minimum one year of sampling
TMF Reclaim Pond	Group A				Water Quality deemed suitable for aquatic life
TMF Pumping Stations / Settling Ponds	Group A				Water Quality deemed suitable for aquatic life
Stockpile Pumping Stations / Settling Ponds	Group A	Toxicity			Water Quality deemed suitable for aquatic life
TMF Reclaim Pond Discharge into Sawbill Bay	Group A, Toxicity				Discontinue after 5 years of acceptable results

**Table 5-2: Surface Water and Groundwater Sampling Requirements for Closure (Continued)**

Sample Locations	Parameters and Frequency				Condition for Change in Frequency or Discontinuation
	Monthly	Quarterly	Twice Annually	Annual	
Upstream and Downstream Monitoring Locations (includes Sawbill Bay, Lizard Lake, and Lynxhead Bay)	Group A				Minimum one year of sampling
<b>Years 2 to 5 After Closure</b>					
Ponded water in Open Pit				Group A	Stable chemistry and within range of background concentrations
TMF Reclaim Pond	Group A	Toxicity			Water Quality deemed suitable for aquatic life
TMF Pumping Stations / Settling Ponds		Group A			Water Quality deemed suitable for aquatic life
WRMF Seepage Pumping Stations		Group A / Toxicity			Water Quality deemed suitable for aquatic life
TMF Reclaim Pond Discharge into Sawbill Bay	Group A				Discontinue after 5 years of acceptable results
Upstream and Downstream Monitoring Locations (includes Sawbill Bay, Lizard Lake, and Lynxhead Bay)		Group A			Stable chemistry and within range of background concentrations
<b>After Open Pit Overflow</b>					
Open Pit overflow into Marmion Reservoir	Group A / Toxicity				Discontinue after 5 years of acceptable results
<b>Groundwater</b>					
<b>Year 1 After closure</b>					
Upstream and downstream of TMF			Group A		Minimum one year of sampling
Upstream and downstream of WRMF			Group A		Minimum one year of sampling
Downstream of the site			Group A		Minimum on year of sampling
<b>Years 2 to 5 After Closure</b>					
Upstream and downstream of TMF				Group A	Stable chemistry and within range of background concentrations
Upstream and downstream of WRMF				Group A	Stable chemistry and within range of background concentrations
Downstream of the site				Group A	Stable chemistry and within range of background concentrations

**Notes:**

- Group A: Field Parameters:** pH, conductivity, temperature

**Laboratory Parameters:** pH, alkalinity, acidity, conductivity, TSS, TDS, hardness, ammonium, nitrate, sulphate, aluminum, arsenic, cadmium, calcium, chromium, cobalt, copper, iron, lead, mercury, molybdenum, nickel, zinc, cyanide

**Toxicity:** acute lethality testing

## **5.3 Biological Monitoring**

Biological monitoring will be conducted throughout operations, closure and post-closure, in order to confirm no changes on number, diversity, density, richness, type and relative abundance of taxa. The indices to be used to monitor the health of benthic communities will be selected in accordance with the Metal Mining Environmental Effects Monitoring Technical Guidance Document (EC 2012).

The following sections outline the proposed aquatic and terrestrial post-closure monitoring programs.

### **5.3.1 Aquatic Monitoring Program**

It is expected that the aquatic flora and fauna in the Upper Marmion Reservoir will be equivalent to pre-development conditions in the sense that it will allow the continuation of the recreational fishing activities in the area. However, due to mining operations, Mitta Lake, located within the west pit footprint and API #2 in the TMF will be drained during the construction phase and any associated aquatic habitat will be lost. The fish habitat suitability at closure will be assessed through water quality and flows regime monitoring and evaluation of quantity of habitats, habitat types and their connectivity community composition, fish distribution and monitoring of metal burden in northern pike muscle tissue, and compared to data obtained from the baseline studies as well as data collected during operations.

Benthic invertebrate and phytoplankton sampling will be conducted at closure and 5 years after closure. Reference monitoring points would be established at closure for the purposes of conducting the surveys. The amount of sampling and sampling techniques will be conducted as per the Environment Canada guidelines, and the data collected will be compared to the baseline conditions to help demonstrate that conditions are improving or remaining stable following closure. The results of the benthic and phytoplankton sampling program will be summarized and assessed based on the number, diversity, type and relative abundance of taxa. If after 5 years it can be shown that there are no lingering effects as a result of operations, an application could be made to the MNM to terminate the monitoring program.

Fisheries inventories will be carried out to demonstrate that conditions in the waterways and water bodies are the same or improving following closure.

After the open pits are flooded to an elevation of 420 m there will be seasonal discharges through the cut channel into the Upper Marmion Reservoir, close to the location of the operational discharge of treated water. The lake resulting from the flooding of the open pits will not be developed as aquatic habitat.

### **5.3.2 Terrestrial Monitoring Program**

Re-vegetated areas will be inspected twice annually during the growing season (late spring and late summer) during the active reclamation phase and annually thereafter for a period of up to 5 years following closure, to determine the success of the program (adequate cover and resistance to erosion) and the need for any remedial work. The species mix or mixes for site re-vegetation will be determined through onsite test work programs to be conducted during operations and progressive reclamation, to help ensure re-vegetation success at closure.

Inspections will be carried out visually and will include photographic records. During monitoring, particular attention will be focused on potentially erosion prone areas such as slopes. Signs of gully, rilling, and/or slumping will be identified for follow-up action. Photographic records will be standardized to the extent possible to allow year to year comparisons of vegetation success. Based on these surveys, areas of poor, or incomplete, vegetation cover will be identified.

## **6.0 EXPECTED SITE CONDITIONS AT CLOSURE**

Figure 6-1 shows the expected long term post-closure conditions of the Project Site. Expected long-term site conditions at closure with respect to land use, site topography, surface and groundwater conditions, and terrestrial and aquatic flora and fauna are described below.

### **6.1 Land Use**

The overall intent of closure and rehabilitation activities is to restore the Project Site to its former land use, or to an acceptable alternative land use that is self-sustaining. Most of the Project Site will return to mixed forest (i.e. combination of mixed hardwoods and coniferous (boreal forest) trees) habitat, with the exception of the waste rock stockpile and the open pits (which will be surrounded with a boulder wall). In such conditions, the Project Site would constitute a terrestrial habitat and access would be available / possible in the long-term for the purposes of tourism / recreational fishing, hunting, and trapping, as well as economic uses such as resource extraction and forestry, as outlined in Section 2.2.

### **6.2 Post-closure Site Ownership**

The Mining Act allows for the return of property to the Crown for properly closed mine sites. At closure, OHRG will endeavour to return parts of the property back to the Crown, once they have been brought back to a stable and sustainable state. Any areas requiring post-closure monitoring as identified in Section 5.0, including the TMF and open pits, will remain under the ownership of OHRG until such time that it can be shown that discharge from those facilities meets regulatory requirements under passive conditions.

### **6.3 Site Topography**

The proposed Project Site will occupy a total area of about 1,300 hectares (ha). At final closure, the principal topographic changes to the Project Site relative to the pre-development conditions will include the following:

- The TMF, raised in a conical shape formation approximately 63 m in elevation from the central discharge point to the lowest existing elevation surrounding the facility, with the tailings sloped at 3%.
- The Ore Processing Facility Area will have been raised about 25 m above the previously existing ground surface.
- A waste rock stockpile rising about 160 m above existing ground and with an overall slope of 2.5H:1V.
- A re-vegetated overburden stockpile rising up to about 60 m above existing ground and an overall slope of 3H:1V.
- Two open pits, flooded to an elevation of 420 m (max pond depth of about 320 m in the west pit).
- Runoff and seepage collection ponds (to be decommissioned once water quality is deemed suitable for direct discharge to the environment).

- A few on-site roads to allow access for post-closure monitoring and maintenance

Aside from a few buildings and infrastructure elements which will remain temporarily after closure for water management purposes, most of the Project Site (excluding the waste rock stockpile and the open pits) will largely be reclaimed and re-vegetated.

## 6.4 Surface and Groundwater Conditions

The seepage collection ponds for the TMF and stockpiles will be maintained at closure until run-off water quality from those Project Site components are deemed suitable for direct discharge to the environment.

Once decommissioned, the TMF reclaim pond will remain active with a reduced storage capacity (below elevation 420 masl) and footprint area. Drainage from the TMF reclaim pond will flow westward via a drainage channel and discharge into Sawbill Bay (Figure 6-1).

The water level in the flooded open pits would reach a maximum elevation of about 420 m. The flooded area will occupy an area of about 210 ha, with a storage capacity of about 172 M-m<sup>3</sup>. Groundwater flow in the bedrock is likely to return to pre-mining conditions with the exception of some interaction with the open pits. As stated in Section 4.7, it is estimated that it will take about 78 years for the open pits to flood and that stratification of water in the flooded open pits will allow for suitable water quality for direct discharge into Sawbill Bay.

Apart from the construction of the TMF drainage channel, no permanent re-alignments or diversions of surface streams are expected at closure.

## 6.5 Terrestrial Flora and Fauna

The total affected footprint area associated with the Project components corresponds to about 1,300 ha. The primary change in the vegetation communities post-closure will be the replacement of forest with re-vegetated areas, either slightly elevated above ground surface or more substantially elevated as in the case of the TMF and overburden stockpile. No re-vegetation is planned for the waste rock stockpile.

Following closure, rehabilitated portions of the Project Site will gradually develop a grassland cover, which will gradually revert to forest cover through the process of natural succession. Vegetation re-growth will be accelerated to the practicable extent, so the habitats can be return to a productive condition as soon as possible.

Efforts will be made during construction to minimize the area impacted by Project facilities that affect wildlife and any disturbance will be mitigated. Based on the conclusions in the terrestrial assessment technical support document (Golder, 2013b), only one residual effect, on the loss and fragmentation of habitat on upland breeding birds, cannot be fully mitigated and will linger throughout the lifetime of the Project and into closure. The habitat loss that will occur is confined to the Project mine site and thus the geographic extent is evaluated as low. However, the habitat loss is reversible with time (Golder, 2013 b). Following the life of mine, most of the disturbed areas will be reclaimed to a more natural state. However, the WRMF and the open pits will not be reclaimed.



The Project Site will be able to support the current species of animals and no major barriers will exist post-closure to the movement of animal species. The resulting habitat at closure will include greater topographic hills and a mixture of several habitat types which will support a more diverse wildlife community.

Project infrastructure remaining after closure (e.g., on-site roads, pumping stations, and the power distribution system) is expected to be minor and relatively localized.

## 6.6 Aquatic Flora and Fauna

Based on information gathered from public consultation, Upper Marmion Reservoir is a popular destination for both local and tourist anglers, with roughly half of fishing pressure coming from non-resident anglers (Jackson 2007). As such, it is reasonable to assume that there will be concerns from the tourism sector regarding potential impacts on Upper Marmion Reservoir as a result of the Project, including post-closure effects.

Due to mining operations, Mitta Lake, located within the west pit footprint and API #2 in the TMF will be drained during the construction phase and any associated aquatic habitat will be lost. Based on aquatic sampling surveys performed by Golder (Golder 2012c), both Mitta Lake and API #2 display fish communities (namely baitfish and northern pike) that will be affected due to the loss of both littoral and open lake habitat.

It is expected that fisheries enhancement will commence at the start-up of mining (in the form of habitat compensation in response to the draining of Mitta Lake and API #2 in the TMF). This could involve the development of spawning and nursery habitats, which would persist and be monitored post-closure.

Biological monitoring will be conducted throughout operations, closure and post-closure, in order to confirm no changes on number, diversity, density, richness, type and relative abundance of taxa as described in Section 5.3. The indices to be used to monitor the health of benthic and fish communities will be selected in accordance with the Metal Mining Environmental Effects Monitoring Technical Guidance Document (Environment Canada 2012). It is expected that the aquatic flora and fauna in the Upper Marmion Reservoir will be equivalent to pre-development conditions and will allow the continuation of the recreational fishing activities in the area. The fish habitat suitability at closure will be assessed through aquatic sediment quality, water quality and flows regimes monitoring and evaluation of quantity of habitats, habitat types and their connectivity community composition, fish distribution and monitoring of metal burden in northern pike muscle tissue.

Final grading at closure will restore the majority of the original catchments and/or create drainage features to replicate original drainage to receivers. After the open pits are flooded to an elevation of 420 m there will be seasonal discharges through the cut channel into the Upper Marmion Reservoir, close to the location of the operational discharge of treated water. The quality of the discharge water is expected to be similar to that of the pre-development discharge from Mitta Lake into Upper Marmion Reservoir. The lake resulting from the flooding of the open pits will not be developed as aquatic habitat, though introduction of local fish species may naturally occur.

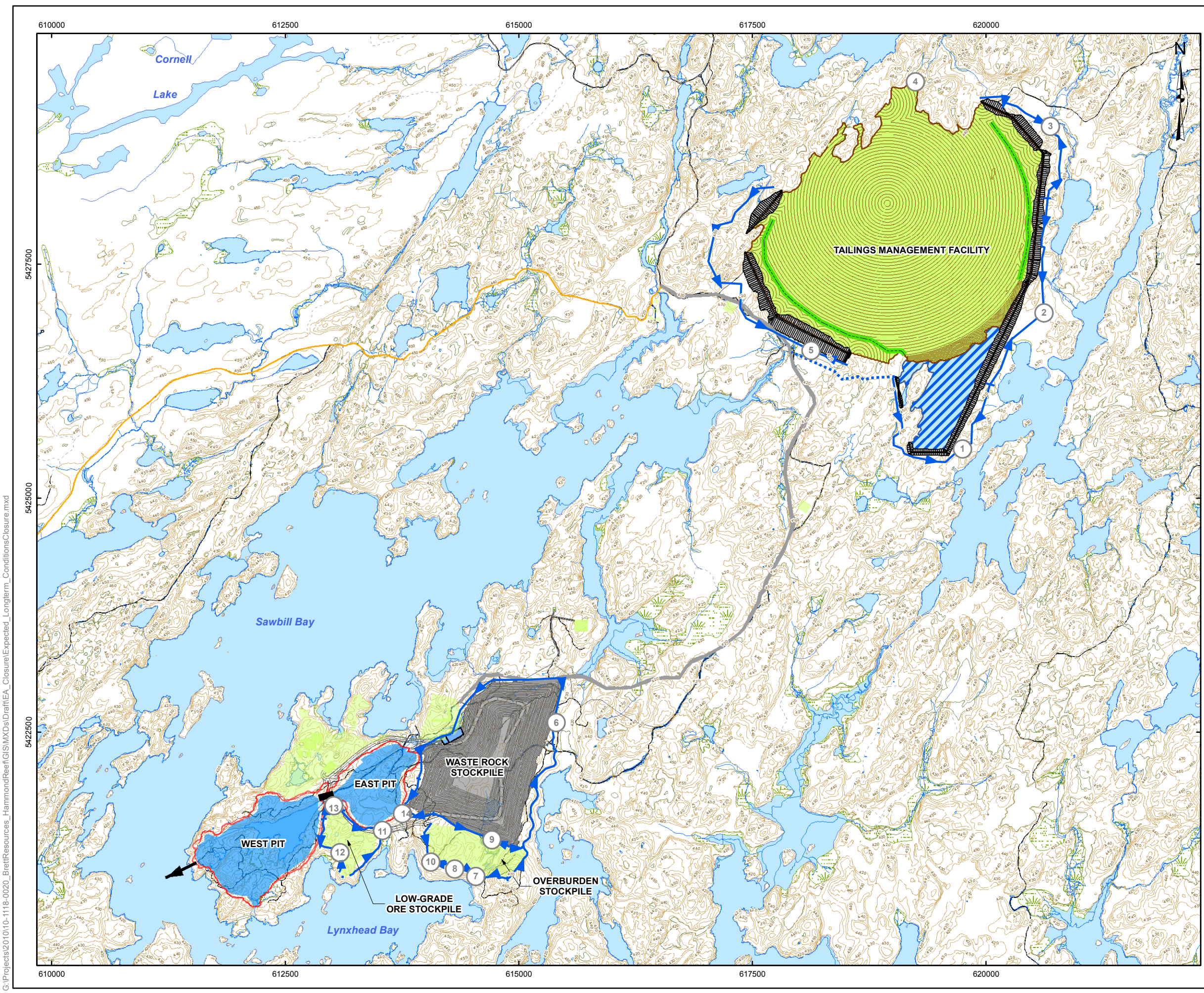

### LEGEND

- Index Contour (5m interval)
- Ditch
- Marsh/Swamp
- River/Stream
- Road
- Trail
- Lake
- Wetland
- Decommissioned Pumping Station
- Proposed Ditch
- Pit Spillover Point
- Excavated Channel
- Tailings Drainage Channel Alignment
- Erosion Protected Channel
- Mine Site Road
- Access Road (Hardtack / Sawbill)
- Intermediate Collection Pond
- Revegetated Surface
- Open Pit Pond
- Waste Rock Stockpile
- Open Pit
- Tailings Management Facility Reclaim Pond

### NOTES

1. Water in Tailings Management Facility Reclaim Pond will be redirected by ditch to Sawbill Bay once water quality is acceptable.
2. When the water quality in individual seepage collection ponds is acceptable for discharge, the ponds will be decommissioned.

### REFERENCE

Base Data - Provided by OSISKO Hammond Reef Gold Project Ltd.  
 Base Data - MNR NRVIS, obtained 2004  
 Produced by Golder Associates Ltd under licence from Ontario Ministry of Natural Resources, © Queens Printer 2008  
 Projection: Transverse Mercator Datum: NAD 83 Coordinate System: UTM Zone 15N

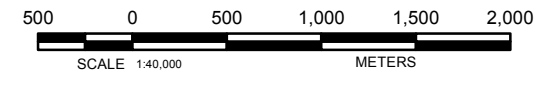

<b>PROJECT</b>	HAMMOND REEF GOLD PROJECT ATIKOKAN, ONTARIO, CANADA		
<b>TITLE</b>	<b>EXPECTED LONG-TERM POST-CLOSURE SITE CONDITIONS</b>		
	PROJECT NO.	10-1118-0020	SCALE AS SHOWN
	DESIGN	CGE 14 Nov. 2008	VERSION 1
	CHECK	RC 4 Feb. 2013	<b>FIGURE: 6-1</b>
	REVIEW	KAB 4 Feb. 2013	

G:\Projects\2010\10-1118-0020\_BrettResources\_HammondReef\GIS\MXDs\Drawn\EA\_Closure\Expected\_Longterm\_Conditions\Closure.mxd

## **7.0 LIST OF REFERENCES**

- Environment Canada. 2012. *Metal Mining Technical Guidance for Environmental Effects Monitoring*.
- Golder (Golder Associates Ltd). 2013a. *Site Water Quality Technical Support Document, Hammond Reef Gold Project*. Version 1 report submitted to Osisko Hammond Reef Gold Ltd., February, 2013, 106 pp.
- Golder. 2013b. *Terrestrial Ecology Technical Support Document, Hammond Reef Gold Project*. Version 1 report submitted to Osisko Hammond Reef Gold Ltd., February 2013, 194 pp.
- Golder. 2013c. *Aquatic Environment Technical Support Document, Hammond Reef Gold Project*. Version 1 report submitted to Osisko Hammond Reef Gold Ltd., February 2013, 154 pp.
- Golder . 2012a. *Preliminary Closure Concepts*. Technical memorandum to Osisko Hammond Reef Gold Ltd. September 20, 2012. 6 pp.
- Golder. 2012b. *Hammond Reef Project – Preliminary Pit Flooding Model*. Draft technical memorandum. October 2012. 6 pp.
- Jackson. 2007. *Status of Walleye Population in Lower Marmion Lake: 2007 Assessment and Management Options*. 15 pp.
- NOAA (U.S. National Oceanic and Atmospheric Administration). 2012. *Glossary of Hydrologic Terms*. Available at: [http://www.nws.noaa.gov/os/hod/SHManual/SHMan014\\_glossary.htm](http://www.nws.noaa.gov/os/hod/SHManual/SHMan014_glossary.htm)
- U.S. Department of Interior. 2012. *Bureau of Reclamation Glossary*. Bureau of Reclamation. Available at <http://www.usbr.gov/projects/glossary.jsp#L>

## 8.0 GLOSSARY OF TERMS

**Table 8-1: Glossary of Terms**

<b>Term</b>	<b>Definition</b>
Erosion	A gradual wearing away of soil or rock by running water, waves, or wind. Concrete surface disturbance caused by cavitation, abrasion from moving particles in water, impact of pedestrian or vehicular traffic, or impact of ice floes. Surface displacement of soil caused by weathering, dissolution, abrasion, or other transporting. (U.S. Department of Interior 2012)
Overburden	Rock or soil overlying bedrock.
Phytoplankton	Small, usually microscopic plants (such as algae), found in lakes, reservoirs, and other bodies of water. (U.S. Department of Interior 2012)
Runoff	That part of precipitation that flows toward the streams on the surface of the ground or within the ground. Runoff is composed of base flow and surface runoff. (NOAA 2012)
Seepage	The interstitial movement of water that may take place through a dam, its foundation, or abutments. (NOAA 2012)

## **9.0 LIST OF ABBREVIATIONS, ACRONYMS AND INITIALISMS**

**Table 9-1: List of Abbreviations, Acronyms and Initialisms**

<b>Acronym</b>	<b>Definition</b>
ARA	Aggregate Resources Act
C of A	Certificate of Approval
ECA	Environmental Compliance Approval
ETP	Effluent Treatment Plant
MHEA	Maximum Horizontal Earthquake Acceleration
MNDM	Ministry of Northern Development and Mines
MNR	Ministry of Natural Resources
OHRG	Osisko Hammond Reef Gold Ltd.
PPCP	Processing plant collection pond
PWQO	Provincial Water Quality Objectives
TDS	Total Dissolved Solids
TMF	Tailings Management Facility
TSS	Total Suspended Solids
WRMF	Waste Rock Management Facility

## 10.0 LIST OF UNITS

Table 10-1: List of Units

Unit	Abbreviation
cubic metres per hour	m <sup>3</sup> /h
cubic metres per year	m <sup>3</sup> /yr
hectares	ha
kilometres	km
metre	m
metres above sea level	masl
million cubic metres	M-m <sup>3</sup>
million tonnes	Mt
percent	%
horizontal: vertical slope	H:V

# **APPENDIX 4.I**

## **Flow Model for Year 1 of Closure**

# Sheet 1

## Site Wide Deterministic Flow (Water Balance) Model Closure Condition Average Climatic Conditions

Mine	Osisko Hammond Reef Gold Project
Owner(s)	Osisko Hammond Reef Gold Ltd.
Operator	Osisko Hammond Reef Gold Ltd.
Location	Atikokan, Ontario
Product	Gold
Revision #	A
Date	November 7, 2012
Level of study	Feasibility
Configuration	Closure - End of Year 1
Golder Project #	11-1118-0117 (2000)

Data are only input into the orange shaded cells. Relevant data is automatically transferred to other sheets.  
Each sheet is password protected except for the orange shaded cells. The password is simply Golder.

**Golder Associates**



# Sheet 2

## Table of Contents

Sheet #

### INTRODUCTION

- 1 Cover Sheet
- 2 Table of Contents
- 3 Model Set-up
- 3 Water Management Assumptions
- 3 Symbols and Abbreviations
- 4 Flow Logic Diagram

### INPUT DATA

- 5 Hydrological Data
- 6 Watershed Areas
- 7 Runoff from Precipitation

### MONTHLY WATER BALANCES - By Pumping Station

- |     |                              |     |                              |
|-----|------------------------------|-----|------------------------------|
| 8-1 | Waste Rock Stockpile         | 8-6 | Overburden Stockpile         |
| 8-2 | Tailings Management Facility | 8-7 | Low Grade Ore Stockpile      |
| 8-3 | Detonator Storage Area       | 8-8 | Intermediate Collection Pond |
| 8-4 | Emulsion Plant               | 8-9 | Open Pit                     |
| 8-5 | Process Plant                |     |                              |

### SUMMARY OF WATER BALANCES

- 9 Summary of All Flows

**Note:** This sheet is protected. The password is simply Golder.

# Sheet 3

## Model Set-up

- The flow model is developed on linked Excel spreadsheets. Input data are only required in the orange shaded cells. The calculations are automatically carried out and linked to the relevant cells on other sheets.
- The flow logic and a list of flows specific to this mine site are shown on the sheet entitled "4 Flow Logic Diagram".
- Precipitation, evaporation, sublimation, seepage and runoff coefficients are input in the "5 Hydrological Data" sheet. The data on this sheet can be easily manipulated to model the impact of varying climatic conditions.
- The watersheds at the mine site, their surface area and the percentage covered by different land surface types are input in the sheet entitled "6 Watershed Areas".
- Runoff from the different land surface types in the watersheds at the mine site is calculated on the "7 Runoff from Precipitation" sheet.
- The sheets that follow ("8-1 Waste Rock Stockpile", "8-2 TMF", "8-3 Detonator Storage Area", "8-4 Emulsion Plant", "8-5 Process Plant", "8-6 Overburden", "8-7 Low-grade ore stockpile", "8-8 ICP", and "8-9 Open Pit") show the monthly inflows and outflows to the different watersheds on the mine site.
- All the monthly inflows and outflows to the different watersheds on the mine site are summarized on the sheet entitled "9 Summary of Flows" at the end of the workbook.

## Water Management Assumptions

- It is assumed that the runoff from all the site watersheds will initially be conveyed either by gravity or pumping to the open pit to promote backflooding.
- The reclaim pond in the Tailings Management Area has a maximum storage capacity of 6.2 M-m<sup>3</sup> based on its configuration. A minimum pond volume of 410,000 m<sup>3</sup> has been assumed based on a water elevation of 430 m in the pond.

**Note:** This sheet is protected. The password is simply Golder.

## Sheet 4 Flow Logic Diagram and List of Flows

<b>Mine:</b>	Osisko Hammond Reef Gold Project	<b>Revision #:</b>	A
<b>Project #:</b>	11-1118-0117 (2000)	<b>Level of Study:</b>	Feasibility
<b>Date:</b>	7-Nov-12	<b>Configuration:</b>	Closure - End of Year 1

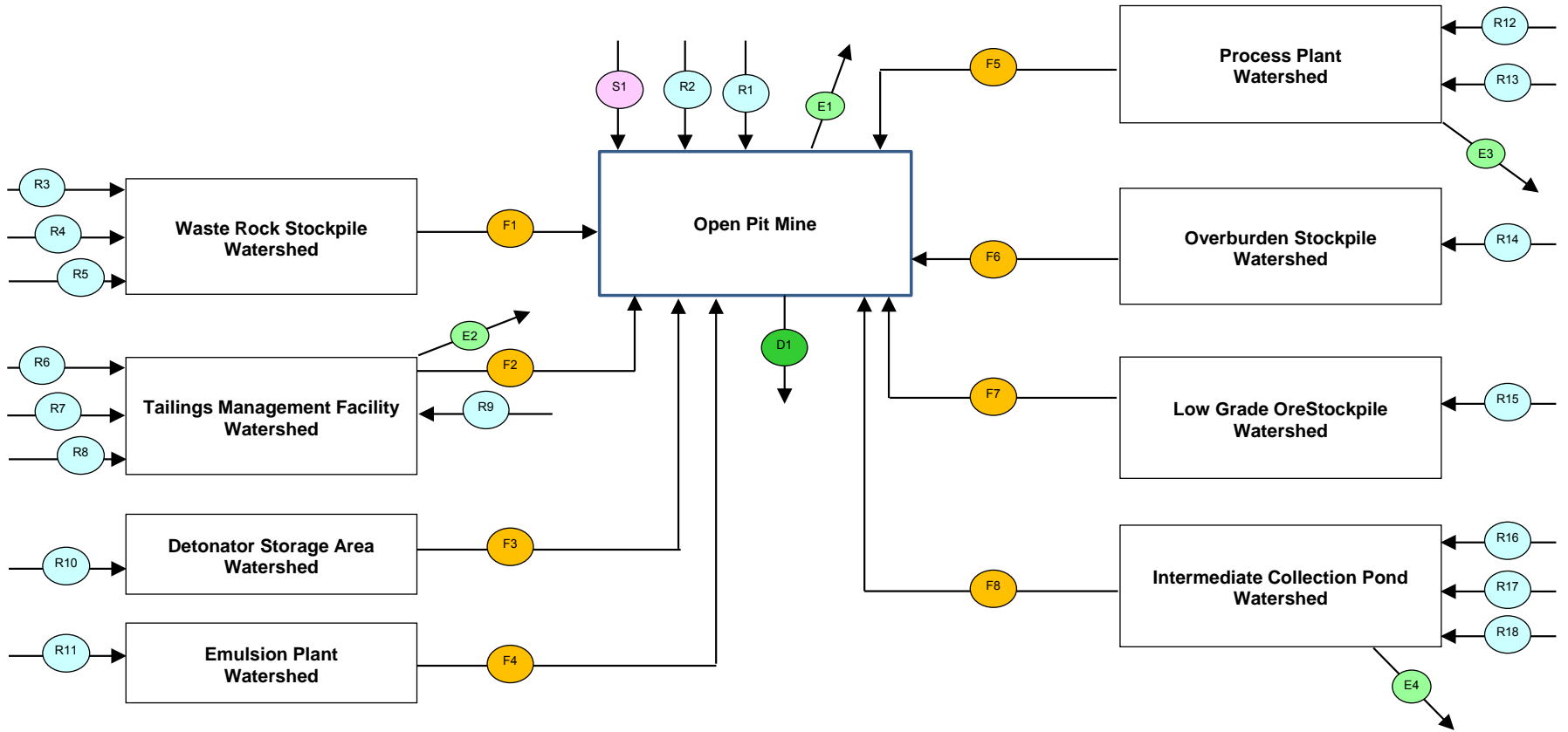

Area	Flow No.	Description	Area	Flow No.	Description
<b>Flows associated with runoff from precipitation (R)</b>	R1	Open pit mine	<b>Flows associated with runoff from precipitation (R)</b>	R1	Runoff from pit walls
	R2	Open pit mine		R2	Direct precipitation to pond
	R3	Waste Rock Stockpile		R3	Runoff from waste rock
	R4			Runoff from remediated prepared ground	
	R5	Runoff from natural ground		R5	Runoff from natural ground
	R6	Tailings Management Facility		R6	Runoff from natural ground
	R7			Direct precipitation to pond	
	R8			Runoff from waste rock	
	R9	Runoff from re-vegetated tailings		R9	Runoff from re-vegetated tailings
	R10	Detonator Storage Area		R10	Runoff from remediated prepared ground
	R11	Emulsion Plant		R11	Runoff from remediated prepared ground
	R12	Process Plant Site		R12	Runoff from remediated prepared ground
	R13			Direct precipitation to pond	
	R14	Overburden Stockpile		R14	Runoff from overburden stockpile
	R15	Low Grade Ore Stockpile		R15	Runoff from ore stockpile
	R16	Intermediate Collection Pond		R16	Runoff from natural ground
	R17			Runoff from remediated prepared ground	
	R18			Direct precipitation to pond	
			<b>Evaporation from ponds (E)</b>	E1	Pit Lake
				E2	Tailings Management Facility Reclaim Pond
				E3	Process Plant Pond
				E4	Intermediate Collection Pond
			<b>Surface flows between elements (F)</b>	F1	Waste Rock Stockpile to Open Pit
				F2	TMF to Open Pit
				F3	Detonator Storage Area to Open Pit
				F4	Emulsion Plant to Open Pit
				F5	Process Plant watershed to Open Pit
				F6	Overburden Stockpile to Open Pit
				F7	Low Grade Ore Stockpile to Open Pit
				F8	Intermediate Collection Pond to Open Pit
			<b>Discharge to environment (D)</b>	D1	Inflow to Mitta Lake
			<b>Seepage Flows (S)</b>	S1	Seepage into Open Pit

## Sheet 5 Hydrological Data

Mine:	Osisko Hammond Reef Gold Project	Level of Study:	Feasibility	Date:	7-Nov-12
Project #:	11-1118-0117 (2000)	Revision No:	A	Configuration:	Closure - End of Year 1

Meteorological Station(s)	- Location	Atikokan (Climate ID: 6020379)			
	- Elevation (m)	395.3			
	- Mean annual precipitation (mm)	739.6			
	- Distance from the site (km)	24			

Month	Precipitation (Note 1)			Sublimation (Note 2)		Factored Runoff (Notes 3 and 4)														Monthly runoff (Note 4)			
	Annual selected for flow modelling (mm/yr)		758.0	Rate estimate (mm/d)	0.3	From natural ground		From Ponds		From Waste Rock		From Overburden Stockpile		From Low Grade Ore Stockpile		From Remediated Prepared Ground		From Vegetated Tailings			From Pit Walls		Expressed as a % of accumulation
	Mean	Monthly Distribution				Precipitation	Months with sublimation (% of mm/d)	Runoff factor	Factored runoff used in the flow model	Runoff factor	Factored runoff used in the flow model	Runoff factor	Factored runoff used in the flow model	Runoff factor	Factored runoff used in the flow model	Runoff factor	Factored runoff used in the flow model	Runoff factor	Factored runoff used in the flow model		Runoff factor	Factored runoff used in the flow model	
	(mm)	(% of total)	(mm)	(mm)	(mm)	(mm)	(mm)	(mm)	(mm)	(mm)	(mm)	(mm)	(mm)	(mm)	(mm)	(mm)	(mm)	(mm)	(mm)		(mm)	(mm)	(%)
Aug	97.8	13.2	100.2	0	0.0	0.40	40.1	1.00	100.2	0.85	85.2	0.40	40.1	0.40	40.1	0.55	55.1	0.40	40.1	0.85	85.2	100	
Sep	91.6	12.4	93.9	0	0.0	0.50	46.9	1.00	93.9	0.85	79.8	0.50	46.9	0.50	46.9	0.60	56.3	0.50	46.9	0.85	79.8	100	
Oct	68.4	9.2	70.1	0	0.0	0.30	21.0	1.00	70.1	0.85	59.6	0.30	21.0	0.30	21.0	0.50	35.0	0.30	21.0	0.85	59.6	100	
Nov	48.2	6.5	49.4	100	9.0	0.80	32.3	1.00	40.4	0.85	34.3	0.80	32.3	0.80	32.3	0.80	32.3	0.55	22.2	0.95	38.4	60	
Dec	27.9	3.8	28.6	100	9.3	0.80	15.4	1.00	19.3	0.85	16.4	0.80	15.4	0.80	15.4	0.80	15.4	0.55	10.6	0.95	18.3	35	
Jan	28.8	3.9	29.5	100	9.3	0.80	16.2	1.00	20.2	0.85	17.2	0.80	16.2	0.80	16.2	0.80	16.2	0.55	11.1	0.95	19.2	10	
Feb	24.7	3.3	25.3	100	8.4	0.80	13.5	1.00	16.9	0.85	14.4	0.80	13.5	0.80	13.5	0.80	13.5	0.55	9.3	0.95	16.1	0	
Mar	37.4	5.1	38.3	100	9.3	0.80	23.2	1.00	29.0	0.85	24.7	0.80	23.2	0.80	23.2	0.80	23.2	0.55	16.0	0.95	27.6	10	
Apr	42.9	5.8	44.0	100	9.0	0.80	28.0	1.00	35.0	0.85	29.7	0.80	28.0	0.80	28.0	0.80	28.0	0.55	19.2	0.95	33.2	100	
May	70.8	9.6	72.6	0	0.0	0.80	58.0	1.00	72.6	0.85	61.7	0.80	58.0	0.80	58.0	0.75	54.4	0.55	39.9	0.85	61.7	100	
Jun	103.3	14.0	105.9	0	0.0	0.30	31.8	1.00	105.9	0.85	90.0	0.30	31.8	0.30	31.8	0.50	52.9	0.30	31.8	0.85	90.0	100	
Jul	97.9	13.2	100.3	0	0.0	0.25	25.1	1.00	100.3	0.85	85.3	0.25	25.1	0.25	25.1	0.48	47.7	0.25	25.1	0.85	85.3	100	
<b>TOTAL</b>	<b>739.7</b>	<b>100.0</b>	<b>758.0</b>		<b>54.3</b>	<b>0.52</b>	<b>351.6</b>	<b>1.00</b>	<b>703.7</b>	<b>0.85</b>	<b>598.1</b>	<b>0.52</b>	<b>351.6</b>	<b>0.52</b>	<b>351.6</b>	<b>0.62</b>	<b>430.1</b>	<b>0.43</b>	<b>293.2</b>	<b>0.88</b>	<b>614.2</b>		

Month	Days/month	Lake Evaporation
		(mm)
Aug	31	104.8
Sep	30	64.8
Oct	31	34.1
Nov	30	0.0
Dec	31	0.0
Jan	31	0.0
Feb	28	0.0
Mar	31	0.0
Apr	30	59.9
May	31	107.4
Jun	30	116.1
Jul	31	129.2
<b>TOTAL</b>	<b>365</b>	<b>616.1</b>

**NOTES:**

- 1 For years that are wetter and drier than the mean year, it usually has to be assumed that the monthly distribution of precipitation is the same as the distribution in the mean year.
- 2 "Sublimation" is the term used to describe the process of snow and ice changing into water vapour in the air without first melting into water. The process is due to a combination of factors such as radiation from the sun, temperature, pressure and other atmospheric conditions.
- 3 The "runoff factor" is the percentage of the precipitation that runs off and ends up in the pond(s). It takes into account evapo-transpiration and infiltration. From natural ground it might be in the order of 20 to 70 % depending on the degree of ground saturation, the intensity of rainfall and the time of year. It will be greater from prepared surfaces and pit walls. For modeling purposes it can be assumed that 100 % of the precipitation that falls on the pond and wet tailings beach ends up in the pond. The runoff from a dry tailings beach is considerably less depending on the degree of saturation of the tailings. Flow measurements are seldom available to correlate with precipitation to establish runoff factors at a new mine site.
- 4 A flow model must be able to account for winter snow accumulation by entering a runoff distribution as a percentage of the total accumulated to date. For example if there is no runoff in January, February and March and 100% runoff in April then the total accumulation of snow over these three months will enter the inflow side of the water balance in April. For the flow model to function properly the precipitation and evaporation data has to start and end on the table in months that 100% of the factored runoff is discharged.
- 5  Information are only required in the orange shaded cells (data input cells).  Values used in the flow model.
- 6 This sheet is protected except for the orange shaded cells. The password is simply Golder.

## Sheet 6 Watershed Areas

<b>Mine:</b>	Osisko Hammond Reef Gold Project	<b>Revision #:</b>	A
<b>Project #:</b>	11-1118-0117 (2000)	<b>Level of Study:</b>	Feasibility
<b>Date:</b>	7-Nov-12	<b>Configuration:</b>	Closure - End of Year 1

Watershed		Sub Watersheds			Flow Number
Facility	Area (ha)	Collecting area	% of total	(m <sup>2</sup> )	
Open pit mine	153.22	Pit Walls	13.3	203,438	R1
		Pond	86.7	1,328,746	R2
		<b>TOTAL</b>	<b>100.0</b>	<b>203,438</b>	
Waste Rock Stockpile (includes Security Building)	192.40	Waste Rock	89.6	1,724,500	R3
		Remediated prepared ground	0.7	13,000	R4
		Natural ground	9.7	186,506	R5
		<b>TOTAL</b>	<b>89.6</b>	<b>1,924,006</b>	
Tailings Management Facility	957.2	Natural ground	15.1	1,446,541	R6
		Pond	6.0	571,456	R7
		From Waste Rock Dams	8.4	808,180	R8
		From Vegetated Tailings	70.5	6,746,016	R9
		<b>TOTAL</b>	<b>100.0</b>	<b>9,572,193</b>	
Detonator Storage Area	0.19	Remediated prepared ground	100	1,902	R10
		<b>TOTAL</b>	<b>100.0</b>	<b>1,902</b>	
Emulsion Plant	2.04	Remediated prepared ground	100	20,402	R11
		<b>TOTAL</b>	<b>100.0</b>	<b>20,402</b>	
Process Plant Site	53.23	Remediated prepared ground	89.2	474,820	R12
		Pond	10.8	57,470	R13
		<b>TOTAL</b>	<b>100.0</b>	<b>474,820</b>	
Overburden Stockpile	39.29	From Overburden	100	392,906	R14
		<b>TOTAL</b>	<b>100.0</b>	<b>392,906</b>	
Low Grade Ore Stockpile	27.45	From Low Grade Ore Stockpile	100	274,506	R15
		<b>TOTAL</b>	<b>100.0</b>	<b>274,506</b>	
Office/Truck shop/Fuel bay to Intermediate Collection Pond	20.39	Remediated natural ground	27.2	55,400	R16
		Remediated prepared ground	72.6	148,125	R17
		Pond	0.2	402	R18
		<b>TOTAL</b>	<b>100.0</b>	<b>203,927</b>	

**Note:** The sub-watersheds are subdivided by percentages which will change as the mine develops.



Data are only input into the orange shaded cells. The calculations are carried out in the other cells and the relevant data are automatically transferred to other sheets. The sheet is protected except for the orange shaded cells. The password is simply Golder.



# Sheet 8-1

## Monthly Flows

### Waste Rock Stockpile Watershed

From cover sheet	<b>Mine:</b>	Osisko Hammond Reef Gold Project	<b>Revision #:</b>	A
	<b>Project #:</b>	11-1118-0117 (2000)	<b>Level of Study:</b>	Feasibility
	<b>Date:</b>	7-Nov-12	<b>Configuration:</b>	Closure - End of Year 1

Month	Flows (m <sup>3</sup> /month)			
	+R3	+R4	+R5	-F2
	Runoff from Waste Rock (From Sheet 8)	Runoff from remediated prepared ground (From Sheet 8)	Runoff from natural ground (From Sheet 8)	Pumped flow to Open Pit (Calculated)
<b>Aug</b>	146,904	717	7,477	-155,098
<b>Sep</b>	137,591	732	8,753	-147,077
<b>Oct</b>	102,743	456	3,922	-107,120
<b>Nov</b>	35,525	252	3,616	-39,393
<b>Dec</b>	18,186	129	1,851	-20,166
<b>Jan</b>	6,340	45	645	-7,031
<b>Feb</b>	0	0	0	0
<b>Mar</b>	12,440	88	1,266	-13,794
<b>Apr</b>	163,204	1,158	16,612	-180,974
<b>May</b>	106,348	707	10,825	-117,880
<b>Jun</b>	155,166	688	5,923	-161,777
<b>Jul</b>	147,055	619	4,678	-152,352
<b>TOTAL</b>	<b>1,031,501</b>	<b>5,591</b>	<b>65,568</b>	<b>-1,102,661</b>

- Notes:**
- 1 Input data are not required on this sheet. The information is automatically transferred from other sheets or calculated on this sheet.
  - 2 All the flows are summarized on the "Summary of Flows" sheet at the end of the model.
  - 3 The table must start with the same month as the runoff sheets.
  - 4 This sheet is protected. The password is simply Golder.

# Sheet 8-2

## Monthly Flows

### Tailings Management Facility Watershed

From cover sheet	<b>Mine:</b>	Osisko Hammond Reef Gold Project	<b>Revision #:</b>	A
	<b>Project #:</b>	11-1118-0117 (2000)	<b>Level of Study:</b>	Feasibility
	<b>Date:</b>	7-Nov-12	<b>Configuration:</b>	Closure - End of Year 1

Month	Flows (m <sup>3</sup> /month)					
	+R6	+R7	+R8	+R9	-E2	-F3
	Runoff from natural ground (From Sheet 8)	Direct precipitation to ponds (From Sheet 8)	Runoff from waste rock dams (From Sheet 8)	Runoff from re-vegetated tailings (From Sheet 8)	Evaporation from Pit Lake (From Sheet 6)	Pumped flow to Open Pit (Calculated)
<b>Aug</b>	57,989	57,271	68,846	270,433	-59,889	-394,650
<b>Sep</b>	67,891	53,640	64,482	316,611	-36,916	-465,708
<b>Oct</b>	30,417	40,055	48,150	141,853	-19,487	-240,988
<b>Nov</b>	28,046	13,850	16,649	89,921	0	-148,465
<b>Dec</b>	14,357	7,090	8,523	46,032	0	-76,002
<b>Jan</b>	5,005	2,472	2,971	16,048	0	-26,497
<b>Feb</b>	0	0	0	0	0	0
<b>Mar</b>	9,821	4,850	5,830	31,487	0	-51,987
<b>Apr</b>	128,845	63,625	76,485	413,103	-34,230	-647,828
<b>May</b>	83,959	41,460	49,840	269,189	-61,374	-383,073
<b>Jun</b>	45,937	60,492	72,718	214,231	-66,346	-327,032
<b>Jul</b>	36,280	57,330	68,917	169,193	-73,832	-257,887
<b>TOTAL</b>	<b>508,548</b>	<b>402,134</b>	<b>483,409</b>	<b>1,978,102</b>	<b>-352,074</b>	<b>-3,020,118</b>

- Notes:**
- 1 Input data are not required on this sheet. The information is automatically transferred from other sheets or calculated on this sheet.
  - 2 All the flows are summarized on the "Summary of Flows" sheet at the end of the model.
  - 3 The table must start with the same month as the runoff sheets.
  - 4 This sheet is protected. The password is simply Golder.



# Sheet 8-3

## Monthly Flows

### Detonator Storage Area Watershed

From cover sheet	<b>Mine:</b>	Osisko Hammond Reef Gold Project	<b>Revision #:</b>	A
	<b>Project #:</b>	11-1118-0117 (2000)	<b>Level of Study:</b>	Feasibility
	<b>Date:</b>	7-Nov-12	<b>Configuration:</b>	Closure - End of Year 1

Month	Flows (m <sup>3</sup> /month)	
	+R10	-F4
	From Remediated prepared ground (From Sheet 8)	Pumped flow to Open Pit (Calculated)
<b>Aug</b>	105	-105
<b>Sep</b>	107	-107
<b>Oct</b>	67	-67
<b>Nov</b>	37	-37
<b>Dec</b>	19	-19
<b>Jan</b>	7	-7
<b>Feb</b>	0	0
<b>Mar</b>	13	-13
<b>Apr</b>	169	-169
<b>May</b>	103	-103
<b>Jun</b>	101	-101
<b>Jul</b>	91	-91
<b>TOTAL</b>	<b>818</b>	<b>-818</b>

- Notes:**
- 1 Input data are not required on this sheet. The information is automatically transferred from other sheets or calculated on this sheet.
  - 2 All the flows are summarized on the "Summary of Flows" sheet at the end of the model.
  - 3 The table must start with the same month as the runoff sheets.
  - 4 This sheet is protected. The password is simply Golder.

# Sheet 8-4

## Monthly Flows

### Emulsion Plant Watershed

From cover sheet	<b>Mine:</b>	Osisko Hammond Reef Gold Project	<b>Revision #:</b>	A
	<b>Project #:</b>	11-1118-0117 (2000)	<b>Level of Study:</b>	Feasibility
	<b>Date:</b>	7-Nov-12	<b>Configuration:</b>	Closure - End of Year 1

Month	Flows (m <sup>3</sup> /month)	
	+R11	-F5
	From Remediated prepared ground (From Sheet 8)	Pumped flow to Open Pit (Calculated)
<b>Aug</b>	1,125	-1,125
<b>Sep</b>	1,149	-1,149
<b>Oct</b>	715	-715
<b>Nov</b>	396	-396
<b>Dec</b>	202	-202
<b>Jan</b>	71	-71
<b>Feb</b>	0	0
<b>Mar</b>	139	-139
<b>Apr</b>	1,817	-1,817
<b>May</b>	1,110	-1,110
<b>Jun</b>	1,080	-1,080
<b>Jul</b>	972	-972
<b>TOTAL</b>	<b>8,775</b>	<b>-8,775</b>

- Notes:**
- 1 Input data are not required on this sheet. The information is automatically transferred from other sheets or calculated on this sheet.
  - 2 All the flows are summarized on the "Summary of Flows" sheet at the end of the model.
  - 3 The table must start with the same month as the runoff sheets.
  - 4 This sheet is protected. The password is simply Golder.

# Sheet 8-5

## Monthly Flows

### Process Plant Watershed

From cover sheet	<b>Mine:</b>	Osisko Hammond Reef Gold Project	<b>Revision #:</b>	A
	<b>Project #:</b>	11-1118-0117 (2000)	<b>Level of Study:</b>	Feasibility
	<b>Date:</b>	7-Nov-12	<b>Configuration:</b>	Closure - End of Year 1

Month	Flows (m <sup>3</sup> /month)			
	+R12	+R13	-E3	-F6
	From remediated prepared ground  (From Sheet 8)	Direct Precipitation to Pond  (From Sheet 8)	Evaporation from Process Pond  (From Sheet 6)	Pumped flow to Open Pit  (Calculated)
<b>Aug</b>	26,172	5,760	-6,023	-25,909
<b>Sep</b>	26,742	5,394	-3,713	-28,424
<b>Oct</b>	16,641	4,028	-1,960	-18,709
<b>Nov</b>	9,206	1,393	0	-10,599
<b>Dec</b>	4,713	713	0	-5,426
<b>Jan</b>	1,643	249	0	-1,892
<b>Feb</b>	0	0	0	0
<b>Mar</b>	3,224	488	0	-3,711
<b>Apr</b>	42,293	6,399	-3,442	-45,249
<b>May</b>	25,837	4,170	-6,172	-23,834
<b>Jun</b>	25,131	6,083	-6,672	-24,542
<b>Jul</b>	22,627	5,765	-7,425	-20,967
<b>TOTAL</b>	<b>204,227</b>	<b>40,441</b>	<b>-35,407</b>	<b>-209,262</b>

- Notes:**
- 1 Input data are not required on this sheet. The information is automatically transferred from other sheets or calculated on this sheet.
  - 2 All the flows are summarized on the "Summary of Flows" sheet at the end of the model.
  - 3 The table must start with the same month as the runoff sheets.
  - 4 This sheet is protected. The password is simply Golder.

# Sheet 8-6

## Monthly Flows

### Overburden Stockpile Watershed

From cover sheet	<b>Mine:</b>	Osisko Hammond Reef Gold Project	<b>Revision #:</b>	A
	<b>Project #:</b>	11-1118-0117 (2000)	<b>Level of Study:</b>	Feasibility
	<b>Date:</b>	7-Nov-12	<b>Configuration:</b>	Closure - End of Year 1

Month	Flows (m <sup>3</sup> /month)	
	+R14	-F7
	From remediated prepared ground (From Sheet 8)	Pumped flow to Open Pit (Calculated)
<b>Aug</b>	15,751	-15,751
<b>Sep</b>	18,440	-18,440
<b>Oct</b>	8,262	-8,262
<b>Nov</b>	7,618	-7,618
<b>Dec</b>	3,900	-3,900
<b>Jan</b>	1,360	-1,360
<b>Feb</b>	0	0
<b>Mar</b>	2,667	-2,667
<b>Apr</b>	34,997	-34,997
<b>May</b>	22,805	-22,805
<b>Jun</b>	12,477	-12,477
<b>Jul</b>	9,854	-9,854
<b>TOTAL</b>	<b>138,131</b>	<b>-138,131</b>

- Notes:**
- 1 Input data are not required on this sheet. The information is automatically transferred from other sheets or calculated on this sheet.
  - 2 All the flows are summarized on the "Summary of Flows" sheet at the end of the model.
  - 3 The table must start with the same month as the runoff sheets.
  - 4 This sheet is protected. The password is simply Golder.

# Sheet 8-7

## Monthly Flows

### Low Grade Ore Stockpile Watershed

From cover sheet	<b>Mine:</b>	Osisko Hammond Reef Gold Project	<b>Revision #:</b>	A
	<b>Project #:</b>	11-1118-0117 (2000)	<b>Level of Study:</b>	Feasibility
	<b>Date:</b>	7-Nov-12	<b>Configuration:</b>	Closure - End of Year 1

Month	Flows (m <sup>3</sup> /month)	
	+R15	-F8
	From remediated prepared ground (From Sheet 8)	Pumped flow to Open Pit (Calculated)
<b>Aug</b>	11,004	-11,004
<b>Sep</b>	12,883	-12,883
<b>Oct</b>	5,772	-5,772
<b>Nov</b>	5,322	-5,322
<b>Dec</b>	2,725	-2,725
<b>Jan</b>	950	-950
<b>Feb</b>	0	0
<b>Mar</b>	1,864	-1,864
<b>Apr</b>	24,451	-24,451
<b>May</b>	15,933	-15,933
<b>Jun</b>	8,717	-8,717
<b>Jul</b>	6,885	-6,885
<b>TOTAL</b>	<b>96,506</b>	<b>-96,506</b>

- Notes:**
- 1 Input data are not required on this sheet. The information is automatically transferred from other sheets or calculated on this sheet.
  - 2 All the flows are summarized on the "Summary of Flows" sheet at the end of the model.
  - 3 The table must start with the same month as the runoff sheets.
  - 4 This sheet is protected. The password is simply Golder.

# Sheet 8-8

## Monthly Flows

### Intermediate Collection Pond Watershed

From cover sheet	<b>Mine:</b>	Osisko Hammond Reef Gold Project	<b>Revision #:</b>	A
	<b>Project #:</b>	11-1118-0117 (2000)	<b>Level of Study:</b>	Feasibility
	<b>Date:</b>	7-Nov-12	<b>Configuration:</b>	Closure - End of Year 1

Month	Flows (m <sup>3</sup> /month)				
	+R16	+R17	+R18	-E4	-F9
	From remediated prepared ground (From Sheet 8)	From remediated prepared ground (From Sheet 8)	From remediated prepared ground (From Sheet 8)	Evaporation from ICP (From Sheet 6)	Pumped flow to Open Pit (Calculated)
<b>Aug</b>	2,221	8,165	40	-42	-10,384
<b>Sep</b>	2,600	8,342	38	-26	-10,954
<b>Oct</b>	1,165	5,191	28	-14	-6,371
<b>Nov</b>	1,074	2,872	10	0	-3,956
<b>Dec</b>	550	1,470	5	0	-2,025
<b>Jan</b>	192	513	2	0	-706
<b>Feb</b>	0	0	0	0	0
<b>Mar</b>	376	1,006	3	0	-1,385
<b>Apr</b>	4,935	13,194	45	-24	-18,149
<b>May</b>	3,215	8,060	29	-43	-11,262
<b>Jun</b>	1,759	7,840	43	-47	-9,595
<b>Jul</b>	1,389	7,059	40	-52	-8,436
<b>TOTAL</b>	<b>19,476</b>	<b>63,711</b>	<b>283</b>	<b>-248</b>	<b>-83,223</b>

- Notes:**
- 1 Input data are not required on this sheet. The information is automatically transferred from other sheets or calculated on this sheet.
  - 2 All the flows are summarized on the "Summary of Flows" sheet at the end of the model.
  - 3 The table must start with the same month as the runoff sheets.
  - 4 This sheet is protected. The password is simply Golder.

# Sheet 8-9

## Monthly Flows

### Open Pit Watershed

From cover sheet	<b>Mine:</b>	Osisko Hammond Reef Gold Project	<b>Revision #:</b>	A
	<b>Project #:</b>	11-1118-0117 (2000)	<b>Level of Study:</b>	Feasibility
	<b>Date:</b>	7-Nov-12	<b>Configuration:</b>	Closure - End of Year 1

Month	Flows (m <sup>3</sup> /month)													
	+R1	+R2	+S1	-E1	+F1	+F2	+F3	+F4	+F5	+F6	+F7	+F8	-	-D1
	From Pit Walls (From Sheet 8)	Direct Precipitation to Pond (From Sheet 8)	Seepage into Open Pit (Note 5)	Evaporation from Pit Lake (From Sheet 6)	From Waste Rock Stockpile Watershed (From Sheet 9-1)	From TMF Watershed (From Sheet 9-2)	From Detonator Storage Watershed (From Sheet 9-3)	From Emulsion Plant Watershed (From Sheet 9-4)	From Process Plant Watershed (From Sheet 9-15)	From Overburden Stockpile Watershed (From Sheet 9-6)	From Low Grade Ore Stockpile Watershed (From Sheet 9-7)	From Intermediate Collection Pond Watershed (From Sheet 9-8)	Volume retained in the Open Pit (Calculated)	Overflow to Environment (Calculated)
<b>Aug</b>	17,330	133,166	16,148	-139,253	155,098	394,650	105	1,125	25,909	15,751	11,004	10,384	641,417	0
<b>Sep</b>	16,232	124,724	15,627	-85,837	147,077	465,708	107	1,149	28,424	18,440	12,883	10,954	755,488	0
<b>Oct</b>	12,121	93,135	16,148	-45,310	107,120	240,988	67	715	18,709	8,262	5,772	6,371	464,097	0
<b>Nov</b>	4,684	32,203	15,627	0	39,393	148,465	37	396	10,599	7,618	5,322	3,956	268,299	0
<b>Dec</b>	2,398	16,485	16,148	0	20,166	76,002	19	202	5,426	3,900	2,725	2,025	145,495	0
<b>Jan</b>	836	5,747	16,148	0	7,031	26,497	7	71	1,892	1,360	950	706	61,242	0
<b>Feb</b>	0	0	14,585	0	0	0	0	0	0	0	0	0	14,585	0
<b>Mar</b>	1,640	11,276	16,148	0	13,794	51,987	13	139	3,711	2,667	1,864	1,385	104,625	0
<b>Apr</b>	21,518	147,941	15,627	-79,592	180,974	647,828	169	1,817	45,249	34,997	24,451	18,149	1,059,128	0
<b>May</b>	12,546	96,403	16,148	-142,707	117,880	383,073	103	1,110	23,834	22,805	15,933	11,262	558,389	0
<b>Jun</b>	18,305	140,655	15,627	-154,267	161,777	327,032	101	1,080	24,542	12,477	8,717	9,595	565,641	0
<b>Jul</b>	17,348	133,302	16,148	-171,674	152,352	257,887	91	972	20,967	9,854	6,885	8,436	452,569	0
<b>TOTAL</b>	<b>124,957</b>	<b>935,039</b>	<b>190,129</b>	<b>-818,640</b>	<b>1,102,661</b>	<b>3,020,118</b>	<b>818</b>	<b>8,775</b>	<b>209,262</b>	<b>138,131</b>	<b>96,506</b>	<b>83,223</b>	<b>5,090,976</b>	<b>0</b>

**Notes:**

- 1 Input data are not required on this sheet. The information is automatically transferred from other sheets or calculated on this sheet.
- 2 All the flows are summarized on the "Summary of Flows" sheet at the end of the model.
- 3 The table must start with the same month as the runoff sheets.
- 4 This sheet is protected. The password is simply Golder.
- 5 Seepage rate is based on a maximum inflow rate of 375 m<sup>3</sup>/day for each of the East and West pits at the their ultimate configuration. A combined daily rate of 520.9 m<sup>3</sup>/day for the end of closure Year 1 was calculated by assuming a linear reduction in the seepage rate from the maximum rate at the ultimate configuration to 0 m<sup>3</sup>/h at elevation 431m (Mitta Lake elevation under existing conditions). The pit flooding model predicts that at the end of closure year 1 the pit water elevations will be 194.9 and 288.9m for the West and East Pits respectively.

## Sheet 9 Summary of All Flows

Mine:	Osisko Hammond Reef Gold Project	Project #:	11-1118-0117 (2000)	Date:	7-Nov-12	Revision #	A	Annual Precipitation:	758 mm	Model year:	Closure - End of Year 1				
		Flow (m <sup>3</sup> )													
		August	September	October	November	December	January	February	March	April	May	June	July	Annual	
<b>Flows associated with processing the ore</b>		31	30	31	30	31	31	28	31	30	31	30	31		
<b>Runoff from precipitation</b>														1	
R1	Open Pit Mine	Runoff from pit walls	17,330	16,232	12,121	4,684	2,398	836	0	1,640	21,518	12,546	18,305	17,348	124,957
R2		Direct precipitation to ponds	133,166	124,724	93,135	32,203	16,485	5,747	0	11,276	147,941	96,403	140,655	133,302	935,039
R3	Waste Rock Stockpile	Runoff from waste rock	146,904	137,591	102,743	35,525	18,186	6,340	0	12,440	163,204	106,348	155,166	147,055	1,031,601
R4		Runoff from remediated prepared ground	717	732	456	252	129	45	0	88	1,158	707	688	619	5,591
R5		Runoff from natural ground	7,477	8,753	3,922	3,616	1,851	645	0	1,266	16,612	10,825	5,923	4,678	65,568
R6	Tailings Management Facility	Runoff from natural ground	57,989	67,891	30,417	28,046	14,357	5,005	0	9,821	128,845	83,959	45,937	36,280	508,548
R7		Direct precipitation to ponds	57,271	53,640	40,055	13,850	7,090	2,472	0	4,850	63,625	41,460	60,492	57,330	402,134
R8		Runoff from waste rock	68,846	64,482	48,150	16,649	8,523	2,971	0	5,830	76,485	49,840	72,718	68,917	483,409
R9		Runoff from re-vegetated tailings	270,433	316,611	141,853	89,921	46,032	16,048	0	31,487	413,103	269,189	214,231	169,193	1,978,102
R10	Detonator Storage Area	Runoff from remediated prepared ground	105	107	67	37	19	7	0	13	169	103	101	91	818
R11	Emulsion Plant	Runoff from remediated prepared ground	1,125	1,149	715	396	202	71	0	139	1,817	1,110	1,080	972	8,775
R12	Process Plant Site	Runoff from remediated prepared ground	26,172	26,742	16,641	9,206	4,713	1,643	0	3,224	42,293	25,837	25,131	22,627	204,227
R13		Direct precipitation to ponds	5,760	5,394	4,028	1,393	713	249	0	488	6,399	4,170	6,083	5,765	40,441
R14	Overburden Stockpile	Runoff from overburden stockpile	15,751	18,440	8,262	7,618	3,900	1,360	0	2,667	34,997	22,805	12,477	9,854	138,131
R15	Low Grade Ore Stockpile	Runoff from stockpile	11,004	12,883	5,772	5,322	2,725	950	0	1,864	24,451	15,933	8,717	6,885	96,506
R16	Intermediate Collection Pond	Runoff from natural ground	2,221	2,600	1,165	1,074	550	192	0	376	4,935	3,215	1,759	1,389	19,476
R17		Runoff from remediated prepared ground	8,165	8,342	5,191	2,872	1,470	513	0	1,006	13,194	8,060	7,840	7,059	63,711
R18		Direct precipitation to ponds	40	38	28	10	5	2	0	3	45	29	43	40	283
<b>Evaporation</b>															
E1	Pit Lake	139,253	85,837	45,310	0	0	0	0	0	79,592	142,707	154,267	171,674	818,640	
E2	Tailings Management Facility Reclaim Pond	59,889	36,916	19,487	0	0	0	0	0	34,230	61,374	66,346	73,832	352,074	
E3	Process Plant Pond	6,023	3,713	1,960	0	0	0	0	0	3,442	6,172	6,672	7,425	35,407	
E4	Intermediate Collection Pond	42	26	14	0	0	0	0	0	24	43	47	52	248	
<b>Surface flows between elements</b>															
F1	Waste Rock Stockpile to Open Pit	155,098	147,077	107,120	39,393	20,166	7,031	0	13,794	180,974	117,880	161,777	152,352	1,102,661	
F2	TMF to Open Pit	394,650	465,708	240,988	148,465	76,002	26,497	0	51,987	647,828	383,073	327,032	257,887	3,020,118	
F3	Detonator Storage Area to Open Pit	105	107	67	37	19	7	0	13	169	103	101	91	818	
F4	Emulsion Plant to Open Pit	1,125	1,149	715	396	202	71	0	139	1,817	1,110	1,080	972	8,775	
F5	Process Plant watershed to Open Pit	25,909	28,424	18,709	10,599	5,426	1,892	0	3,711	45,249	23,834	24,542	20,967	209,262	
F6	Overburden Stockpile to Open Pit	15,751	18,440	8,262	7,618	3,900	1,360	0	2,667	34,997	22,805	12,477	9,854	138,131	
F7	Low Grade Ore Stockpile to Open Pit	11,004	12,883	5,772	5,322	2,725	950	0	1,864	24,451	15,933	8,717	6,885	96,506	
F8	Intermediate Collection Pond to Open Pit	10,384	10,954	6,371	3,956	2,025	706	0	1,385	18,149	11,262	9,595	8,436	83,223	
<b>Discharge to the environment</b>															
D1	Inflow to Mitta Lake	0	0	0	0	0	0	0	0	0	0	0	0	0	
<b>Open Pit</b>															
-	Volume retained in Open Pit	641,417	755,488	464,097	268,299	145,495	61,242	14,585	104,625	1,059,128	558,389	565,641	452,569	5,090,976	

**Note:** Input data are not required on this sheet. The information is automatically transferred from the other sheets. The sheet is protected. The password is simply Golder.  
A negative number means the flow does not exist (note that this convention is not consistent with that used in the rest of the model)



# **APPENDIX 4.II**

## **Flow Model for Long-term Post-closure**

# Sheet 1

## Site Wide Deterministic Flow (Water Balance) Model Ultimate Configuration Average Climatic Conditions

Mine	Osisko Hammond Reef Gold Project
Owner(s)	Osisko Hammond Reef Gold Ltd.
Operator	Osisko Hammond Reef Gold Ltd.
Location	Atikokan, Ontario
Product	Gold
Revision #	A
Date	November 7, 2012
Level of study	Feasibility
Configuration	Post-Closure Conditions
Golder Project #	11-1118-0117 (2000)

Data are only input into the orange shaded cells. Relevant data is automatically transferred to other sheets.  
Each sheet is password protected except for the orange shaded cells. The password is simply Golder.

**Golder Associates**

# Sheet 2

## Table of Contents

Sheet #

### INTRODUCTION

- 1 Cover Sheet
- 2 Table of Contents
- 3 Model Set-up
- 3 Water Management Assumptions
- 3 Symbols and Abbreviations
- 4 Flow Logic Diagram

### INPUT DATA

- 5 Hydrological Data
- 6 Watershed Areas
- 7 Runoff from Precipitation

### MONTHLY WATER BALANCES - By Pumping Station

- |     |                              |      |                              |
|-----|------------------------------|------|------------------------------|
| 8-1 | Open Pit Mine                | 8-6  | Process Plant                |
| 8-2 | Waste Rock Stockpile         | 8-7  | Overburden Stockpile         |
| 8-3 | Tailings Management Facility | 8-8  | Low Grade Ore Stockpile      |
| 8-4 | Detonator Storage Area       | 8-9  | Intermediate Collection Pond |
| 8-5 | Emulsion Plant               | 8-10 | Environment                  |

### SUMMARY OF WATER BALANCES

- 9 Summary of All Flows

**Note:** This sheet is protected. The password is simply Golder.

# Sheet 3

## Model Set-up

- The flow model is developed on linked Excel spreadsheets. Input data are only required in the orange shaded cells. The calculations are automatically carried out and linked to the relevant cells on other sheets.
- The flow logic and a list of flows specific to this mine site are shown on the sheet entitled "4 Flow Logic Diagram".
- Precipitation, evaporation, sublimation, seepage and runoff coefficients are input in the "5 Hydrological Data" sheet. The data on this sheet can be easily manipulated to model the impact of varying climatic conditions.
- The watersheds at the mine site, their surface area and the percentage covered by different land surface types are input in the sheet entitled "6 Watershed Areas".
- Runoff from the different land surface types in the watersheds at the mine site is calculated on the "7 Runoff from Precipitation"
- The sheets that follow ("8-1 Open Pit", "8-2 Waste Rock Stockpile", "8-3 TMF", "8-4 Detonator Storage Area", "8-5 Emulsion Plant", "8-6 Process Plant", "8-7 Overburden", "8-8 Ore", "8-9 ICP", and "8-10 Environment") show the monthly inflows and outflows to the different watersheds on the mine site.
- All the monthly inflows and outflows to the different watersheds on the mine site are summarized on the sheet entitled "9 Summary of Flows" at the end of the workbook.

## Water Management Assumptions

- It is assumed that under long-term post-closure conditions, the runoff from all site components will drain naturally by gravity into Marmion Lake, as the water quality will be deemed suitable for direct discharge.
- It is assumed that the Open pit has been flooded to elevation 420 m and that spillover will occur intermittently based on inflows associated with runoff from precipitation, seepage, and evaporation rates

**Note:** This sheet is protected. The password is simply Golder.

## Sheet 4 Flow Logic Diagram and List of Flows

<b>Mine:</b>	Osisko Hammond Reef Gold Project	<b>Revision #:</b>	A
<b>Project #:</b>	11-1118-0117 (2000)	<b>Level of Study:</b>	Feasibility
<b>Date:</b>	7-Nov-12	<b>Configuration:</b>	Post-Closure Conditions

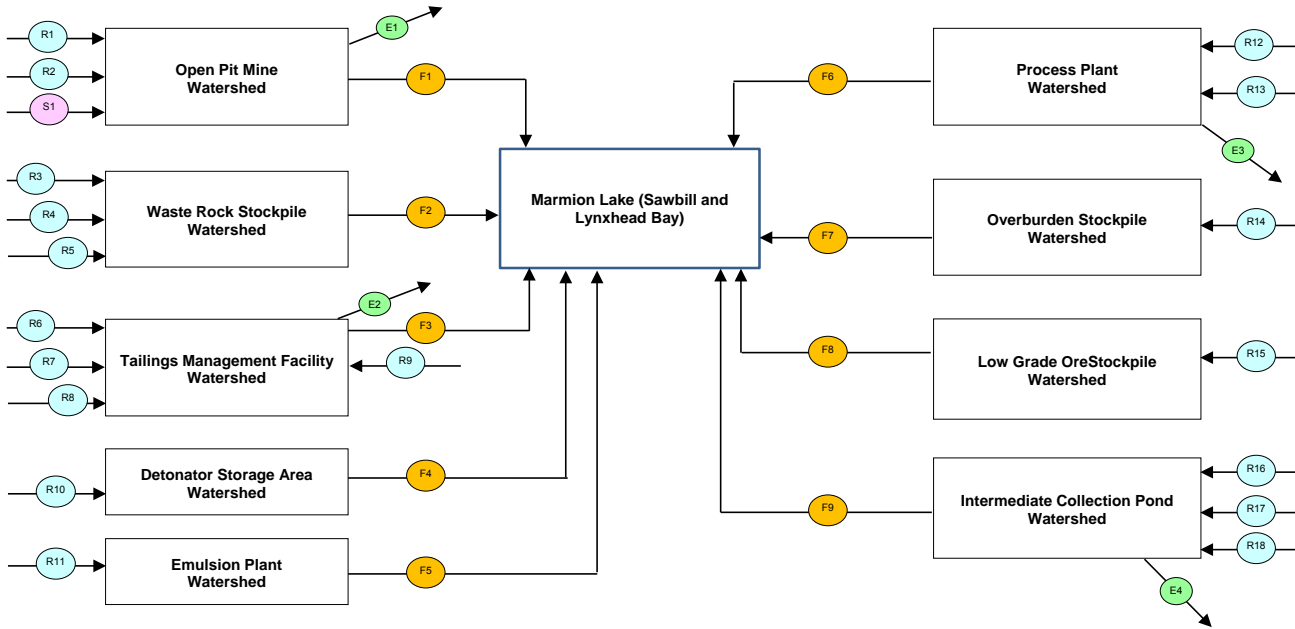

Area	Flow No.	Description	Area	Flow No.	Description	
<b>Flows associated with runoff from precipitation (R)</b>	R1	Open pit mine	<b>Evaporation from ponds (E)</b>	E1	Pit Lake	
	R2	Open pit mine		E2	Tailings Management Facility Reclaim Pond	
	R3	Waste Rock Stockpile		E3	Process Plant Pond	
	R4	Waste Rock Stockpile		E4	Intermediate Collection Pond	
	R5	Waste Rock Stockpile		F1	Open Pit Mine to environment	
	R6	Tailings Management Facility		F2	Waste Rock Stockpile to environment	
	R7	Tailings Management Facility		F3	TMF to environment	
	R8	Tailings Management Facility		F4	Detonator Storage Area to environment	
	R9	Tailings Management Facility		F5	Emulsion Plant to environment	
	R10	Detonator Storage Area	F6	Process Plant watershed to environment		
	R11	Emulsion Plant	F7	Overburden Stockpile to environment		
	R12	Process Plant Site	F8	Low Grade Ore Stockpile to environment		
	R13	Process Plant Site	F9	Intermediate Collection Pond		
	R14	Overburden Stockpile	<b>Seepage Flows (S)</b>	S1	Seepage into Open Pit	
	R15	Low Grade Ore Stockpile		<b>Discharge to environment (D)</b>	D1	Inflow to Mitta Lake
	R16	Intermediate Collection Pond				
	R17	Intermediate Collection Pond				
	R18	Intermediate Collection Pond				

## Sheet 5 Hydrological Data

Mine:	Osisko Hammond Reef Gold Project	Level of Study:	Feasibility	Date:	7-Nov-12
Project #:	11-1118-0117 (2000)	Revision No:	A	Configuration:	Post-Closure Conditions

<b>Meteorological Station(s)</b>	- Location	Atikokan (Climate ID: 6020379)			
	- Elevation (m)	395.3			
	- Mean annual precipitation (mm)	739.6			
	- Distance from the site (km)	24			

Precipitation (Note 1)			Sublimation (Note 2)		Factored Runoff (Notes 3 and 4)															
Month	Annual selected for flow modelling (mm/yr)		758.0	Rate estimate (mm/d)	0.3	From natural ground		From Ponds		From Waste Rock		From Overburden Stockpile		From Low Grade Ore Stockpile		From Remediated Prepared Ground		From Vegetated Tailings		From Pit
	Mean	Monthly Distribution	Precipitation	Months with sublimation (% of mm/d)	Runoff factor	Factored runoff used in the flow model	Runoff factor	Factored runoff used in the flow model	Runoff factor	Factored runoff used in the flow model	Runoff factor	Factored runoff used in the flow model	Runoff factor	Factored runoff used in the flow model	Runoff factor	Factored runoff used in the flow model	Runoff factor	Factored runoff used in the flow model	Runoff factor	Factored runoff used in the flow model
	(mm)	(% of total)	(mm)	(mm)		(mm)		(mm)		(mm)		(mm)		(mm)		(mm)		(mm)		(mm)
Aug	97.8	13.2	100.2	0	0.0	0.40	40.1	1.00	100.2	0.85	85.2	0.40	40.1	0.40	40.1	0.55	55.1	0.40	40.1	0.85
Sep	91.6	12.4	93.9	0	0.0	0.50	46.9	1.00	93.9	0.85	79.8	0.50	46.9	0.50	46.9	0.60	56.3	0.50	46.9	0.85
Oct	68.4	9.2	70.1	0	0.0	0.30	21.0	1.00	70.1	0.85	59.6	0.30	21.0	0.30	21.0	0.50	35.0	0.30	21.0	0.85
Nov	48.2	6.5	49.4	100	9.0	0.80	32.3	1.00	40.4	0.85	34.3	0.80	32.3	0.80	32.3	0.80	32.3	0.55	22.2	0.95
Dec	27.9	3.8	28.6	100	9.3	0.80	15.4	1.00	19.3	0.85	16.4	0.80	15.4	0.80	15.4	0.80	15.4	0.55	10.6	0.95
Jan	28.8	3.9	29.5	100	9.3	0.80	16.2	1.00	20.2	0.85	17.2	0.80	16.2	0.80	16.2	0.80	16.2	0.55	11.1	0.95
Feb	24.7	3.3	25.3	100	8.4	0.80	13.5	1.00	16.9	0.85	14.4	0.80	13.5	0.80	13.5	0.80	13.5	0.55	9.3	0.95
Mar	37.4	5.1	38.3	100	9.3	0.80	23.2	1.00	29.0	0.85	24.7	0.80	23.2	0.80	23.2	0.80	23.2	0.55	16.0	0.95
Apr	42.9	5.8	44.0	100	9.0	0.80	28.0	1.00	35.0	0.85	29.7	0.80	28.0	0.80	28.0	0.80	28.0	0.55	19.2	0.95
May	70.8	9.6	72.6	0	0.0	0.80	58.0	1.00	72.6	0.85	61.7	0.80	58.0	0.80	58.0	0.75	54.4	0.55	39.9	0.85
Jun	103.3	14.0	105.9	0	0.0	0.30	31.8	1.00	105.9	0.85	90.0	0.30	31.8	0.30	31.8	0.50	52.9	0.30	31.8	0.85
Jul	97.9	13.2	100.3	0	0.0	0.25	25.1	1.00	100.3	0.85	85.3	0.25	25.1	0.25	25.1	0.48	47.7	0.25	25.1	0.85
<b>TOTAL</b>	<b>739.7</b>	<b>100.0</b>	<b>758.0</b>		<b>54.3</b>	<b>0.52</b>	<b>351.6</b>	<b>1.00</b>	<b>703.7</b>	<b>0.85</b>	<b>598.1</b>	<b>0.52</b>	<b>351.6</b>	<b>0.52</b>	<b>351.6</b>	<b>0.62</b>	<b>430.1</b>	<b>0.43</b>	<b>293.2</b>	<b>0.88</b>

Month	Days/month	Lake Evaporation
		(mm)
Aug	31	104.8
Sep	30	64.6
Oct	31	34.1
Nov	30	0.0
Dec	31	0.0
Jan	31	0.0
Feb	28	0.0
Mar	31	0.0
Apr	30	59.9
May	31	107.4
Jun	30	116.1
Jul	31	129.2
<b>TOTAL</b>	<b>365</b>	<b>616.1</b>

**NOTES:**

- 1 For years that are wetter and drier than the mean year, it usually has to be assumed that the monthly distribution of precipitation is the same as the distribution in the mean year.
- 2 "Sublimation" is the term used to describe the process of snow and ice changing into water vapour in the air without first melting into water. The process is due to a combination of factors such as radiation from the sun, temperature, pressure and other atmospheric conditions.
- 3 The "runoff factor" is the percentage of the precipitation that runs off and ends up in the pond(s). It takes into account evapo-transpiration and infiltration. From natural ground it might be in the order of 20 to 70 % depending on the degree of ground saturation, the intensity of rainfall and the time of year. It will be greater from prepared surfaces and pit walls. For modeling purposes it can be assumed that 100 % of the precipitation that falls on the pond and wet tailings beach ends up in the pond. The runoff from a dry tailings beach is considerably less depending on the degree of saturation of the tailings. Flow measurements are seldom available to correlate with precipitation to establish runoff factors at a new mine site.
- 4 A flow model must be able to account for winter snow accumulation by entering a runoff distribution as a percentage of the total accumulated to date. For example if there is no runoff in January, February and March and 100% runoff in April then the total accumulation of snow over these three months will enter the inflow side of the water balance in April. For the flow model to function properly the precipitation and evaporation data has to start and end on the table in months that 100% of the factored runoff is discharged.
- 5  Information are only required in the orange shaded cells (data input cells).  Values used in the flow model.
- 6 This sheet is protected except for the orange shaded cells. The password is simply Golder.

## Sheet 6 Watershed Areas

<b>Mine:</b>	Osisko Hammond Reef Gold Project	<b>Revision #:</b>	A
<b>Project #:</b>	11-1118-0117 (2000)	<b>Level of Study:</b>	Feasibility
<b>Date:</b>	7-Nov-12	<b>Configuration:</b>	Post-Closure Conditions

Watershed		Sub Watersheds			Flow Number
Facility	Area (ha)	Collecting area	% of total	(m <sup>2</sup> )	
Open pit mine	153.22	Pit Walls	13.3	203,438	R1
		Pond	86.7	1,328,746	R2
		<b>TOTAL</b>	<b>100.0</b>	<b>203,438</b>	
Waste Rock Stockpile (includes Security Building)	192.40	Waste Rock	89.6	1,724,500	R3
		Remediated prepared ground	0.7	13,000	R4
		Natural ground	9.7	186,506	R5
		<b>TOTAL</b>	<b>89.6</b>	<b>1,924,006</b>	
Tailings Management Facility	957.2	Natural ground	15.1	1,446,541	R6
		Pond	6.0	571,456	R7
		From Waste Rock Dams	8.4	808,180	R8
		From Vegetated Tailings	70.5	6,746,016	R9
		<b>TOTAL</b>	<b>100.0</b>	<b>9,572,193</b>	
Detonator Storage Area	0.19	Remediated prepared ground	100	1,902	R10
		<b>TOTAL</b>	<b>100.0</b>	<b>1,902</b>	
Emulsion Plant	2.04	Remediated prepared ground	100	20,402	R11
		<b>TOTAL</b>	<b>100.0</b>	<b>20,402</b>	
Process Plant Site	53.23	Remediated prepared ground	89.2	474,820	R12
		Pond	10.8	57,470	R13
		<b>TOTAL</b>	<b>100.0</b>	<b>474,820</b>	
Overburden Stockpile	39.29	From Overburden	100	392,906	R14
		<b>TOTAL</b>	<b>100.0</b>	<b>392,906</b>	
Low Grade Ore Stockpile	27.45	From Low Grade Ore	100	274,506	R15
		<b>TOTAL</b>	<b>100.0</b>	<b>274,506</b>	
Office/Truck shop/Fuel bay to Intermediate Collection Pond	20.39	Remediated natural ground	27.2	55,400	R16
		Remediated prepared ground	72.6	148,125	R17
		Pond	0.2	402	R18
		<b>TOTAL</b>	<b>100.0</b>	<b>55,400</b>	

**Note:** The sub-watersheds are subdivided by percentages which will change as the mine develops.



Data are only input into the orange shaded cells. The calculations are carried out in the other cells and the relevant data are automatically transferred to other sheets. The sheet is protected except for the orange shaded cells. The password is simply Golder.





# Sheet 8-1

## Monthly Flows

### Open Pit Watershed

From cover sheet	<b>Mine:</b>	Osisko Hammond Reef Gold Project	<b>Revision #:</b>	A
	<b>Project #:</b>	11-1118-0117 (2000)	<b>Level of Study:</b>	Feasibility
	<b>Date:</b>	7-Nov-12	<b>Configuration:</b>	Post-Closure Conditions

Month	Flows (m <sup>3</sup> /month)				
	+R1	+R2	+S1	-E1	-F1
	From Pit Walls (From Sheet 8)	Direct Precipitation to Pond (From Sheet 8)	Seepage inflow (Note 5)	Evaporation from Pit Lake (From Sheet 6)	Outflow to Marmion Lake (Calculated)
<b>Aug</b>	17,330	133,166	980	-139,253	-12,224
<b>Sep</b>	16,232	124,724	948	-85,837	-56,067
<b>Oct</b>	12,121	93,135	980	-45,310	-60,925
<b>Nov</b>	4,684	32,203	948	0	-37,835
<b>Dec</b>	2,398	16,485	980	0	-19,862
<b>Jan</b>	836	5,747	980	0	-7,563
<b>Feb</b>	0	0	885	0	-885
<b>Mar</b>	1,640	11,276	980	0	-13,896
<b>Apr</b>	21,518	147,941	948	-79,592	-90,816
<b>May</b>	12,546	96,403	980	-142,707	32,779
<b>Jun</b>	18,305	140,655	948	-154,267	-5,641
<b>Jul</b>	17,348	133,302	980	-171,674	20,044
<b>TOTAL</b>	<b>124,957</b>	<b>935,039</b>	<b>11,534</b>	<b>-818,640</b>	<b>-252,889</b>

- Notes:**
- 1 Input data are not required on this sheet. The information is automatically transferred from other sheets or calculated on this sheet.
  - 2 All the flows are summarized on the "Summary of Flows" sheet at the end of the model.
  - 3 The table must start with the same month as the runoff sheets.
  - 4 This sheet is protected. The password is simply Golder.
  - 5 Seepage rate is based on a maximum inflow rate of 375 m<sup>3</sup>/day for each of the East and West pits at their ultimate configuration. A combined daily rate of 31.6 m<sup>3</sup>/day post closure was calculated by assuming a linear reduction in the seepage rate from the maximum rate at the ultimate configuration to 0 m<sup>3</sup>/h at elevation 431m (Mitta Lake elevation under existing conditions). Post closure the proposed maximum pit water elevation is 420m.

# Sheet 8-2

## Monthly Flows

### Waste Rock Stockpile Watershed

From cover sheet	<b>Mine:</b>	Osisko Hammond Reef Gold Project	<b>Revision #:</b>	A
	<b>Project #:</b>	11-1118-0117 (2000)	<b>Level of Study:</b>	Feasibility
	<b>Date:</b>	7-Nov-12	<b>Configuration:</b>	Post-Closure Conditions

Month	Flows (m <sup>3</sup> /month)			
	+R3	+R4	+R5	-F2
	Runoff from Waste Rock (From Sheet 8)	Runoff from remediated prepared ground (From Sheet 8)	Runoff from natural ground (From Sheet 8)	Outflow to Marmion Lake (Calculated)
<b>Aug</b>	146,904	717	7,477	-155,098
<b>Sep</b>	137,591	732	8,753	-147,077
<b>Oct</b>	102,743	456	3,922	-107,120
<b>Nov</b>	35,525	252	3,616	-39,393
<b>Dec</b>	18,186	129	1,851	-20,166
<b>Jan</b>	6,340	45	645	-7,031
<b>Feb</b>	0	0	0	0
<b>Mar</b>	12,440	88	1,266	-13,794
<b>Apr</b>	163,204	1,158	16,612	-180,974
<b>May</b>	106,348	707	10,825	-117,880
<b>Jun</b>	155,166	688	5,923	-161,777
<b>Jul</b>	147,055	619	4,678	-152,352
<b>TOTAL</b>	<b>1,031,501</b>	<b>5,591</b>	<b>65,568</b>	<b>-1,102,661</b>

- Notes:**
- 1 Input data are not required on this sheet. The information is automatically transferred from other sheets or calculated on this sheet.
  - 2 All the flows are summarized on the "Summary of Flows" sheet at the end of the model.
  - 3 The table must start with the same month as the runoff sheets.
  - 4 This sheet is protected. The password is simply Golder.

# Sheet 8-3

## Monthly Flows

### Tailings Management Facility Watershed

From cover sheet	<b>Mine:</b>	Osisko Hammond Reef Gold Project	<b>Revision #:</b>	A
	<b>Project #:</b>	11-1118-0117 (2000)	<b>Level of Study:</b>	Feasibility
	<b>Date:</b>	7-Nov-12	<b>Configuration:</b>	Post-Closure Conditions

Month	Flows (m <sup>3</sup> /month)					
	+R6	+R7	+R8	+R9	-E2	-F3
	Runoff from natural ground (From Sheet 8)	Direct precipitation to ponds (From Sheet 8)	Runoff from waste rock dams (From Sheet 8)	Runoff from re-vegetated tailings (From Sheet 8)	Evaporation from Pit Lake (From Sheet 6)	Outflow to Marmion Lake (Calculated)
<b>Aug</b>	57,989	57,271	68,846	270,433	-59,889	-394,650
<b>Sep</b>	67,891	53,640	64,482	316,611	-36,916	-465,708
<b>Oct</b>	30,417	40,055	48,150	141,853	-19,487	-240,988
<b>Nov</b>	28,046	13,850	16,649	89,921	0	-148,465
<b>Dec</b>	14,357	7,090	8,523	46,032	0	-76,002
<b>Jan</b>	5,005	2,472	2,971	16,048	0	-26,497
<b>Feb</b>	0	0	0	0	0	0
<b>Mar</b>	9,821	4,850	5,830	31,487	0	-51,987
<b>Apr</b>	128,845	63,625	76,485	413,103	-34,230	-647,828
<b>May</b>	83,959	41,460	49,840	269,189	-61,374	-383,073
<b>Jun</b>	45,937	60,492	72,718	214,231	-66,346	-327,032
<b>Jul</b>	36,280	57,330	68,917	169,193	-73,832	-257,887
<b>TOTAL</b>	<b>508,548</b>	<b>402,134</b>	<b>483,409</b>	<b>1,978,102</b>	<b>-352,074</b>	<b>-3,020,118</b>

- Notes:**
- 1 Input data are not required on this sheet. The information is automatically transferred from other sheets or calculated on this sheet.
  - 2 All the flows are summarized on the "Summary of Flows" sheet at the end of the model.
  - 3 The table must start with the same month as the runoff sheets.
  - 4 This sheet is protected. The password is simply Golder.

# Sheet 8-4

## Monthly Flows

### Detonator Storage Area Watershed

From cover sheet	<b>Mine:</b>	Osisko Hammond Reef Gold Project	<b>Revision #:</b>	A
	<b>Project #:</b>	11-1118-0117 (2000)	<b>Level of Study:</b>	Feasibility
	<b>Date:</b>	7-Nov-12	<b>Configuration:</b>	Post-Closure Conditions

Month	Flows (m <sup>3</sup> /month)	
	+R10	-F4
	From Remediated prepared ground (From Sheet 8)	Outflow to Marmion Lake (Calculated)
<b>Aug</b>	105	-105
<b>Sep</b>	107	-107
<b>Oct</b>	67	-67
<b>Nov</b>	37	-37
<b>Dec</b>	19	-19
<b>Jan</b>	7	-7
<b>Feb</b>	0	0
<b>Mar</b>	13	-13
<b>Apr</b>	169	-169
<b>May</b>	103	-103
<b>Jun</b>	101	-101
<b>Jul</b>	91	-91
<b>TOTAL</b>	<b>818</b>	<b>-818</b>

- Notes:**
- 1 Input data are not required on this sheet. The information is automatically transferred from other sheets or calculated on this sheet.
  - 2 All the flows are summarized on the "Summary of Flows" sheet at the end of the model.
  - 3 The table must start with the same month as the runoff sheets.
  - 4 This sheet is protected. The password is simply Golder.

# Sheet 8-5

## Monthly Flows

### Emulsion Plant Watershed

From cover sheet	<b>Mine:</b>	Osisko Hammond Reef Gold Project	<b>Revision #:</b>	A
	<b>Project #:</b>	11-1118-0117 (2000)	<b>Level of Study:</b>	Feasibility
	<b>Date:</b>	7-Nov-12	<b>Configuration:</b>	Post-Closure Conditions

Month	Flows (m <sup>3</sup> /month)	
	+R11	-F5
	From Remediated prepared ground (From Sheet 8)	Outflow to Marmion Lake (Calculated)
<b>Aug</b>	1,125	-1,125
<b>Sep</b>	1,149	-1,149
<b>Oct</b>	715	-715
<b>Nov</b>	396	-396
<b>Dec</b>	202	-202
<b>Jan</b>	71	-71
<b>Feb</b>	0	0
<b>Mar</b>	139	-139
<b>Apr</b>	1,817	-1,817
<b>May</b>	1,110	-1,110
<b>Jun</b>	1,080	-1,080
<b>Jul</b>	972	-972
<b>TOTAL</b>	<b>8,775</b>	<b>-8,775</b>

- Notes:**
- 1 Input data are not required on this sheet. The information is automatically transferred from other sheets or calculated on this sheet.
  - 2 All the flows are summarized on the "Summary of Flows" sheet at the end of the model.
  - 3 The table must start with the same month as the runoff sheets.
  - 4 This sheet is protected. The password is simply Golder.

# Sheet 8-6

## Monthly Flows

### Process Plant Watershed

From cover sheet	<b>Mine:</b>	Osisko Hammond Reef Gold Project	<b>Revision #:</b>	A
	<b>Project #:</b>	11-1118-0117 (2000)	<b>Level of Study:</b>	Feasibility
	<b>Date:</b>	7-Nov-12	<b>Configuration:</b>	Post-Closure Conditions

Month	Flows (m <sup>3</sup> /month)			
	+R12	+R13	-E3	-F6
	From remediated prepared ground (From Sheet 8)	Direct Precipitation to Pond (From Sheet 8)	Evaporation from Process Pond (From Sheet 6)	Outflow to Marmion Lake (Calculated)
<b>Aug</b>	26,172	5,760	-6,023	-25,909
<b>Sep</b>	26,742	5,394	-3,713	-28,424
<b>Oct</b>	16,641	4,028	-1,960	-18,709
<b>Nov</b>	9,206	1,393	0	-10,599
<b>Dec</b>	4,713	713	0	-5,426
<b>Jan</b>	1,643	249	0	-1,892
<b>Feb</b>	0	0	0	0
<b>Mar</b>	3,224	488	0	-3,711
<b>Apr</b>	42,293	6,399	-3,442	-45,249
<b>May</b>	25,837	4,170	-6,172	-23,834
<b>Jun</b>	25,131	6,083	-6,672	-24,542
<b>Jul</b>	22,627	5,765	-7,425	-20,967
<b>TOTAL</b>	<b>204,227</b>	<b>40,441</b>	<b>-35,407</b>	<b>-209,262</b>

- Notes:**
- 1 Input data are not required on this sheet. The information is automatically transferred from other sheets or calculated on this sheet.
  - 2 All the flows are summarized on the "Summary of Flows" sheet at the end of the model.
  - 3 The table must start with the same month as the runoff sheets.
  - 4 This sheet is protected. The password is simply Golder.

# Sheet 8-7

## Monthly Flows

### Overburden Stockpile Watershed

From cover sheet	<b>Mine:</b>	Osisko Hammond Reef Gold Project	<b>Revision #:</b>	A
	<b>Project #:</b>	11-1118-0117 (2000)	<b>Level of Study:</b>	Feasibility
	<b>Date:</b>	7-Nov-12	<b>Configuration:</b>	Post-Closure Conditions

Month	Flows (m <sup>3</sup> /month)	
	+R14	-F7
	From remediated prepared ground (From Sheet 8)	Outflow to Marmion Lake (Calculated)
<b>Aug</b>	15,751	-15,751
<b>Sep</b>	18,440	-18,440
<b>Oct</b>	8,262	-8,262
<b>Nov</b>	7,618	-7,618
<b>Dec</b>	3,900	-3,900
<b>Jan</b>	1,360	-1,360
<b>Feb</b>	0	0
<b>Mar</b>	2,667	-2,667
<b>Apr</b>	34,997	-34,997
<b>May</b>	22,805	-22,805
<b>Jun</b>	12,477	-12,477
<b>Jul</b>	9,854	-9,854
<b>TOTAL</b>	<b>138,131</b>	<b>-138,131</b>

- Notes:**
- 1 Input data are not required on this sheet. The information is automatically transferred from other sheets or calculated on this sheet.
  - 2 All the flows are summarized on the "Summary of Flows" sheet at the end of the model.
  - 3 The table must start with the same month as the runoff sheets.
  - 4 This sheet is protected. The password is simply Golder.

# Sheet 8-8

## Monthly Flows

### Mineralized Rock Stockpile Watershed

From cover sheet	<b>Mine:</b>	Osisko Hammond Reef Gold Project	<b>Revision #:</b>	A
	<b>Project #:</b>	11-1118-0117 (2000)	<b>Level of Study:</b>	Feasibility
	<b>Date:</b>	7-Nov-12	<b>Configuration:</b>	Post-Closure Conditions

Month	Flows (m <sup>3</sup> /month)	
	+R15	-F8
	From remediated prepared ground (From Sheet 8)	Outflow to Marmion Lake (Calculated)
<b>Aug</b>	11,004	-11,004
<b>Sep</b>	12,883	-12,883
<b>Oct</b>	5,772	-5,772
<b>Nov</b>	5,322	-5,322
<b>Dec</b>	2,725	-2,725
<b>Jan</b>	950	-950
<b>Feb</b>	0	0
<b>Mar</b>	1,864	-1,864
<b>Apr</b>	24,451	-24,451
<b>May</b>	15,933	-15,933
<b>Jun</b>	8,717	-8,717
<b>Jul</b>	6,885	-6,885
<b>TOTAL</b>	<b>96,506</b>	<b>-96,506</b>

- Notes:**
- 1 Input data are not required on this sheet. The information is automatically transferred from other sheets or calculated on this sheet.
  - 2 All the flows are summarized on the "Summary of Flows" sheet at the end of the model.
  - 3 The table must start with the same month as the runoff sheets.
  - 4 This sheet is protected. The password is simply Golder.



# Sheet 8-9

## Monthly Flows

### Intermediate Collection Pond Watershed

From cover sheet	<b>Mine:</b>	Osisko Hammond Reef Gold Project	<b>Revision #:</b>	A
	<b>Project #:</b>	11-1118-0117 (2000)	<b>Level of Study:</b>	Feasibility
	<b>Date:</b>	7-Nov-12	<b>Configuration:</b>	Post-Closure Conditions

Month	Flows (m <sup>3</sup> /month)				
	+R16	+R17	+R18	-E4	-F9
	From remediated prepared ground (From Sheet 8)	From remediated prepared ground (From Sheet 8)	From remediated prepared ground (From Sheet 8)	Evaporation from ICP (From Sheet 6)	Outflow to Marmion Lake (Calculated)
<b>Aug</b>	2,221	8,165	40	-42	-10,384
<b>Sep</b>	2,600	8,342	38	-26	-10,954
<b>Oct</b>	1,165	5,191	28	-14	-6,371
<b>Nov</b>	1,074	2,872	10	0	-3,956
<b>Dec</b>	550	1,470	5	0	-2,025
<b>Jan</b>	192	513	2	0	-706
<b>Feb</b>	0	0	0	0	0
<b>Mar</b>	376	1,006	3	0	-1,385
<b>Apr</b>	4,935	13,194	45	-24	-18,149
<b>May</b>	3,215	8,060	29	-43	-11,262
<b>Jun</b>	1,759	7,840	43	-47	-9,595
<b>Jul</b>	1,389	7,059	40	-52	-8,436
<b>TOTAL</b>	<b>19,476</b>	<b>63,711</b>	<b>283</b>	<b>-248</b>	<b>-83,223</b>

- Notes:**
- 1 Input data are not required on this sheet. The information is automatically transferred from other sheets or calculated on this sheet.
  - 2 All the flows are summarized on the "Summary of Flows" sheet at the end of the model.
  - 3 The table must start with the same month as the runoff sheets.
  - 4 This sheet is protected. The password is simply Golder.

# Sheet 8-10

## Monthly Flows

### Discharge to Environment

From cover sheet	<b>Mine:</b>	Osisko Hammond Reef Gold Project	<b>Revision #:</b>	A
	<b>Project #:</b>	11-1118-0117 (2000)	<b>Level of Study:</b>	Feasibility
	<b>Date:</b>	7-Nov-12	<b>Configuration:</b>	Post-Closure Conditions

Month	Flows (m <sup>3</sup> /month)									
	+F1	+F2	+F3	+F4	+F5	+F6	+F7	+F8	+F9	-D1
	From Open Pit Mine Watershed (Sheet 9-1)	From Waste Rock Stockpile Watershed (Sheet 9-2)	From TMF Watershed (Sheet 9-3)	From Detonator Storage Watershed (Sheet 9-4)	From Emulsion Plant Watershed (Sheet 9-5)	From Process Plant Watershed (Sheet 9-6)	From Overburden Stockpile Watershed (Sheet 9-7)	From Low Grade Ore Stockpile Watershed (Sheet 9-8)	From Intermediate Collection Pond Watershed (Sheet 9-9)	Inflow to Marmion Lake (Calculated)
<b>Aug</b>	12,224	155,098	394,650	105	1,125	25,909	15,751	11,004	10,384	-626,249
<b>Sep</b>	56,067	147,077	465,708	107	1,149	28,424	18,440	12,883	10,954	-740,809
<b>Oct</b>	60,925	107,120	240,988	67	715	18,709	8,262	5,772	6,371	-448,929
<b>Nov</b>	37,835	39,393	148,465	37	396	10,599	7,618	5,322	3,956	-253,620
<b>Dec</b>	19,862	20,166	76,002	19	202	5,426	3,900	2,725	2,025	-130,326
<b>Jan</b>	7,563	7,031	26,497	7	71	1,892	1,360	950	706	-46,074
<b>Feb</b>	885	0	0	0	0	0	0	0	0	-885
<b>Mar</b>	13,896	13,794	51,987	13	139	3,711	2,667	1,864	1,385	-89,457
<b>Apr</b>	90,816	180,974	647,828	169	1,817	45,249	34,997	24,451	18,149	-1,044,449
<b>May</b>	-32,779	117,880	383,073	103	1,110	23,834	22,805	15,933	11,262	-543,221
<b>Jun</b>	5,641	161,777	327,032	101	1,080	24,542	12,477	8,717	9,595	-550,962
<b>Jul</b>	-20,044	152,352	257,887	91	972	20,967	9,854	6,885	8,436	-437,400
<b>TOTAL</b>	<b>252,889</b>	<b>1,102,661</b>	<b>3,020,118</b>	<b>818</b>	<b>8,775</b>	<b>209,262</b>	<b>138,131</b>	<b>96,506</b>	<b>83,223</b>	<b>-4,912,381</b>

**Notes:**

- 1 Input data are not required on this sheet. The information is automatically transferred from other sheets or calculated on this sheet.
- 2 All the flows are summarized on the "Summary of Flows" sheet at the end of the model.
- 3 The table must start with the same month as the runoff sheets.
- 4 This sheet is protected. The password is simply Golder.

## Sheet 9 Summary of All Flows

Mine:	Osisko Hammond Reef Gold Project	Project #:	11-1118-0117 (2000)	Date:	7-Nov-12	Revision #	A	Annual Precipitation:	758 mm	Model year:	Post-Closure Conditions				
Flow (m <sup>3</sup> )															
	August	September	October	November	December	January	February	March	April	May	June	July	Annual		
	31	30	31	30	31	31	28	31	30	31	30	31	365		
<b>Flows associated with processing the ore</b>															
<b>Runoff from precipitation</b>															
R1	Open Pit Mine	Runoff from pit walls	17,330	16,232	12,121	4,684	2,398	836	0	1,640	21,518	12,546	18,305	17,348	124,957
R2		Direct precipitation to ponds	133,166	124,724	93,135	32,203	16,485	5,747	0	11,276	147,941	96,403	140,655	133,302	935,039
R3		Runoff from waste rock	146,904	137,591	102,743	35,525	18,186	6,340	0	12,440	163,204	106,348	155,166	147,055	1,031,501
R4	Waste Rock Stockpile	Runoff from remediated prepared ground	717	732	456	252	129	45	0	88	1,158	707	688	619	5,591
R5		Runoff from natural ground	7,477	8,753	3,922	3,616	1,851	645	0	1,266	16,612	10,825	5,923	4,678	65,568
R6		Runoff from natural ground	57,989	67,891	30,417	28,048	14,357	5,005	0	9,821	128,845	83,959	45,937	36,280	508,548
R7	Tailings Management Facility	Direct precipitation to ponds	57,271	53,640	40,055	13,850	7,090	2,472	0	4,850	63,625	41,460	60,492	57,330	402,134
R8		Runoff from waste rock	68,846	64,482	48,150	16,649	8,523	2,971	0	5,830	76,485	49,840	72,718	69,917	483,409
R9		Runoff from re-vegetated tailings	270,433	316,511	141,853	89,921	46,032	16,048	0	31,487	413,103	269,189	214,231	169,193	1,978,102
R10	Detonator Storage Area	Runoff from natural ground	105	107	67	37	19	7	0	13	169	103	101	91	818
R11	Emulsion Plant	Runoff from natural ground	1,125	1,149	715	396	202	71	0	139	1,817	1,110	1,080	972	8,775
R12	Process Plant Site	Runoff from remediated prepared ground	26,172	26,742	16,641	9,206	4,713	1,643	0	3,224	42,293	25,837	25,131	22,627	204,227
R13		Direct precipitation to ponds	5,760	5,394	4,028	1,393	713	249	0	488	6,399	4,170	6,083	5,765	40,441
R14	Overburden Stockpile	Runoff from overburden stockpile	15,751	18,440	8,262	7,618	3,900	1,360	0	2,667	34,997	22,805	12,477	9,854	138,131
R15	Low Grade Ore Stockpile	Runoff from stockpile	11,004	12,883	5,772	5,322	2,725	950	0	1,864	24,451	15,933	8,717	6,885	96,506
R16		Runoff from natural ground	2,221	2,600	1,165	1,074	550	192	0	376	4,935	3,215	1,759	1,389	19,476
R17	Intermediate Collection Pond	Runoff from remediated prepared ground	8,165	8,342	5,191	2,872	1,470	513	0	1,006	13,194	8,060	7,840	7,059	63,711
R18		Direct precipitation to ponds	40	38	28	10	5	2	0	3	45	29	43	40	283
<b>Evaporation</b>															
E1	Pit Lake		139,253	85,837	45,310	0	0	0	0	0	79,592	142,707	154,267	171,674	818,640
E2	Tailings Management Facility Reclaim Pond		59,889	36,916	19,487	0	0	0	0	0	34,230	61,374	66,346	73,832	352,074
E3	Process Plant Pond		6,023	3,713	1,960	0	0	0	0	0	3,442	6,172	6,672	7,425	35,407
E4	Intermediate Collection Pond		42	26	14	0	0	0	0	0	24	43	47	52	248
<b>Surface flows between elements</b>															
F1	Open Pit Mine to environment		12,224	56,067	60,925	37,835	19,862	7,563	885	13,896	90,816	-32,779	5,641	-20,044	252,889
F2	Waste Rock Stockpile to environment		155,098	147,077	107,120	39,393	20,166	7,031	0	13,794	180,974	117,880	161,777	152,352	1,102,661
F3	TMF to environment		394,650	465,708	240,988	148,465	76,002	26,497	0	51,987	647,828	383,073	327,032	257,887	3,020,118
F4	Detonator Storage Area to environment		105	107	67	37	19	7	0	13	169	103	101	91	818
F5	Emulsion Plant to environment		1,125	1,149	715	396	202	71	0	139	1,817	1,110	1,080	972	8,775
F6	Process Plant watershed to environment		25,909	28,424	18,709	10,599	5,426	1,892	0	3,711	45,249	23,834	24,542	20,967	209,262
F7	Overburden Stockpile to environment		15,751	18,440	8,262	7,618	3,900	1,360	0	2,667	34,997	22,805	12,477	9,854	138,131
F8	Low Grade Ore Stockpile to environment		11,004	12,883	5,772	5,322	2,725	950	0	1,864	24,451	15,933	8,717	6,885	96,506
F9	Intermediate Collection Pond		10,384	10,954	6,371	3,956	2,025	706	0	1,385	18,149	11,262	9,595	8,436	83,223
<b>Seepage</b>															
S1	Seepage into Open Pit		980	948	980	948	980	980	885	980	948	980	948	980	11,534
<b>Discharge to the environment</b>															
D1	Inflow to Marmion Lake		626,249	740,809	448,929	253,620	130,326	46,074	885	89,457	1,044,449	543,221	550,962	437,400	4,912,381

**Note:** Input data are not required on this sheet. The information is automatically transferred from the other sheets. The sheet is protected. The password is simply Golder. A negative number means the flow does not exist (note that this convention is not consistent with that used in the rest of the model)