



Appendix D.1

Light Impact Assessment Beaver Dam Mine Project, January 28, 2021 as
Completed for the Updated 2021 Beaver Dam Mine EIS



Light Impact Assessment

Beaver Dam Mine Project
Marinette, Nova Scotia

Atlantic Mining NS Inc.

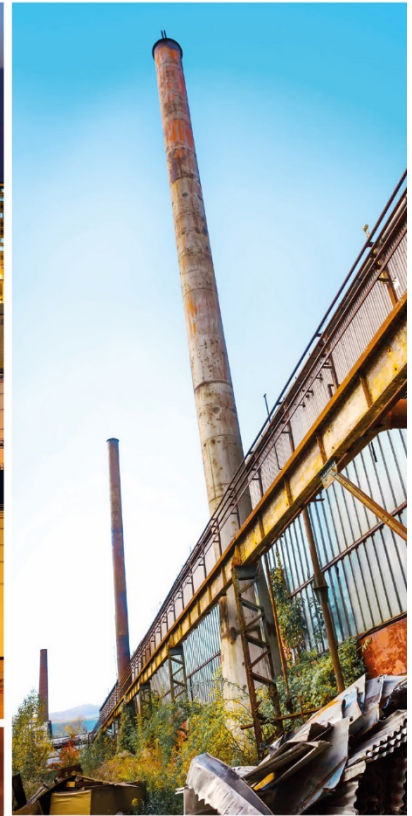



Table of Contents

1.	Introduction.....	1
2.	Baseline Conditions.....	2
3.	Proposed Lighting	2
4.	Sensitive Receptors	4
5.	Method of Assessment.....	4
6.	Results and Discussion	8
7.	Best Management Practices	10
8.	References	11

Figure Index

Figure 1A	Light shed map and Trespass from Beaver Dam Mine and Haul Road Traffic
Figure 1B	Site and Point of Reception Location Plan
Figure 2	Light Source and Receptor Separation Distance Plan - R1
Figure 3	Light Source and Receptor Separation Distance Plan - R2
Figure 4	Light Source and Receptor Separation Distance Plan - R3
Figure 5	Light Source and Receptor Separation Distance Plan - R4
Figure 6	Light Source and Receptor Separation Distance Plan - R5
Figure 7	Light Source and Receptor Separation Distance Plan - R6
Figure 8	Light Source and Receptor Separation Distance Plan - R7
Figure 9	Light Source and Receptor Separation Distance Plan - R8
Figure 10	Light Source and Receptor Separation Distance Plan - R9

Table Index

Table 1	Light Source Summary Tables	3
Table 2	Comparison of Light Levels at Receptors with Published Guidelines	7
Table 3	Distance to Sky Glow Dissipation.....	9

Appendix Index

Appendix A	Supporting Information
Appendix B	Institute of Lighting Professionals Guidance Note for the Reduction of Obtrusive Light



1. Introduction

This report is an update to the Light Impact Assessment Beaver Dam Mine Project (GHD 2017). The updates have been undertaken to reflect updates to the Beaver Dam Mine project description (e.g., reduction of the number of truck), which are described in the Beaver Dam Mine Updated Project Description (AMNS 2021).

GHD has undertaken an analysis of the proposed lighting installations for the proposed Beaver Dam Mine Project (Project) in Marinette, Nova Scotia. The Project is in a rural, mostly wooded area. The impacts of the proposed lighting installations at the mine and along the haul route on nearby sensitive receptors were quantified and compared with the guidelines published by The Institution of Lighting Professionals (ILP) in the document entitled "Guidance Notes for the Reduction of Obtrusive Light" (ILP 2020) included as Appendix B.

This report addresses the requirements specified in the Guidelines for the Preparation of an Environmental Impact Statement (CEAA 2016) that states in 6.1.1 and 6.4.1, respectively:

"existing ambient night-time light levels at the project site and at any other areas where project activities could have an effect on light levels. The EIS will describe night-time illumination levels during different weather conditions and seasons"

effects on the atmospheric environment (e.g. air emissions, noise, light) that could occur within Beaver Lake Indian Reserve 17 and as a result of project components that could require a federal decision."

In addition, this report addresses CEAA 2-5 Information Request that states:

"Provide a light shed map in consideration of Beaver Dam IR 17 and areas identified for current use practices. The model should use a conservative value in estimating moisture or particulate matter in the atmosphere."

The Light shed map and Trespass from Beaver Dam Mine and Haul Road Traffic is provided in Figure 1A.

Definitions

Light trespass is defined as the spilling of light beyond the boundary of the property or area being lit and is primarily a concern at night. Excess obtrusive light can be a nuisance to others, wastes electricity, and indirectly results in unnecessary emissions of greenhouse gases. Light trespass, or light pollution, can also negatively impact the surrounding ecosystem by disrupting the habits of native species. As such, it is important to understand the potential light impacts from this development, and to endeavor to minimize them.

Luminous flux is the quantity of the energy of the light emitted per second in all directions. The unit of luminous flux is lumen (lm).

Illuminance refers to the amount of light that covers a surface. If Φ is the luminous flux and S is the area of the given surface, then the illuminance E is determined by $E = \Phi/S$. Illumination is quantified



in terms of lux. One lux is the illuminance of a 1 square metres (m²) surface uniformly lit by 1 lm of luminous flux.

A residence that may experience an objectionable encroachment of light over the property line is referred to as a *residential receptor* or *sensitive receptor*. This undesirable light spill may include the entry of unwanted light through windows, or direct line of sight to bright light sources.

Effects of light on fauna are described in Information Request CEAA 2-5 and Section 6.13 of the Updated EIS (AMNS 2021) and presented in Figure 1A.

2. Baseline Conditions

The proposed Site is located in a historical mining area surrounded by forest, waterbodies, watercourses and wetlands. The nearest residential receptor to the mine is the Beaver Lake IR 17 (R2) located approximately 5 kilometres (km) southwest. A proposed haul route for transporting ore will connect the mine to the Touquoy Processing Plant, located approximately 19 km southwest of the mine, via approximately 34 km road.

The ILP has developed an Environmental Zone classification system whereby the existing ambient light levels at a site are used to determine the recommended maximum amount of light trespass to nearby receptors. The classification for rural areas, small villages, or relatively dark urban locations is "E2 Low district brightness areas". Based upon this classification, the light trespass limit at an off-site receptor after curfew (typically considered to be 11 PM) is 1 lux, which is the accepted equivalent to moonlight. The after curfew (post-curfew) limit was used to assess the impact of lighting from the mine as mining operations under full-scale operation are scheduled to be 24 hours per day.

Furthermore, the ILP trespass limit at an off-site receptors before curfew is 5 lux (ILP 2020). Atlantic Mining NS Inc. (AMNS) has indicated that trucking transport along the haul route will occur 12 to 16 hours a day, and not during post-curfew hours. No other proposed lighting will exist along the haul route. As such, the light trespass at receptors along the haul route was evaluated against the before curfew (pre-curfew) limit of 5 lux.

3. Proposed Lighting

Table 1 provides a complete listing of the proposed light sources to be installed at the Site. The mobile floodlights located at various points around the mine will be mounted on 8-metre (m) towers, facing downwards. AMNS provided model numbers for these mobile floodlight towers, and using manufacturer's specifications, GHD obtained the luminous flux for each floodlight tower. The supporting specifications are provided in Appendix A. The LED walkway lights illuminating the Operational Facilities area will be positioned on 3-m poles surrounding the area, facing downwards. GHD used specifications of a typical 75 watt LED light used for site lighting applications to obtain the luminous flux for each pole mounted light. Since the exact locations of the lights are unknown at this stage, estimates were used.

Table 1
Light Source Summary Tables
Beaver Dam Mine Project
Atlantic Gold Corporation
Marinette, Halifax Co., Nova Scotia

Percentage of incident lumens assumed to reach the receptor considering directionality and line of site obstructions: **50%**

Area	Source	Power (watts)	Qty	Total Power (watts)	Luminous Flux (1) (lumens)	Receptor #1 (R1)- 9 Beaver Dam Mine Road		Receptor # 2 (R2)- 4112 Highway 224 (Beaver Lake IR 17)		Receptor # 3 (R3)- 4115 Highway 224 (Cottage on Crownland)		Receptor # 4 (R4) - 3492 Highway 224 (Hobbs Property)		Receptor # 5 (R5) - 3379 Highway 224 (McLeod Property)		Receptor # 6 (R6) - 3373 Highway 224 (Smith Property)		Receptor # 7 (R7) - Tangier River (Deepwood Estates Property)		Receptor # 8 (R8) - Tangier River (Musquodoboit Lumber Co Ltd. Property/John Dickson Lease)		Receptor # 9 (R9) - 5579 Mooseland Road (Lloy Property)		
						Approx. Distance (m)	Illuminance (2) (lux)	Approx. Distance (m)	Illuminance (2) (lux)	Approx. Distance (m)	Illuminance (2) (lux)	Approx. Distance (m)	Illuminance (2) (lux)	Approx. Distance (m)	Illuminance (2) (lux)	Approx. Distance (m)	Illuminance (2) (lux)	Approx. Distance (m)	Illuminance (2) (lux)	Approx. Distance (m)	Illuminance (2) (lux)	Approx. Distance (m)	Illuminance (2) (lux)	Approx. Distance (m)
Open Pit	Mobile Equipment (3)																							
	Trucks (various)	6 mounted halogen lights	390	15	5850	117000	6400	1.43E-03	6000	1.63E-03	6050	1.60E-03	6500	1.38E-03	6875	1.24E-03	6900	1.23E-03	13690	3.12E-04	13650	3.14E-04	15260	2.51E-04
	Excavators	6 mounted halogen lights	390	6	2340	46800	6400	5.71E-04	6000	6.50E-04	6050	6.39E-04	6500	5.54E-04	6875	4.95E-04	6900	4.91E-04	13690	1.25E-04	13650	1.26E-04	15260	1.00E-04
	Loaders	6 mounted halogen lights	390	4	1560	31200	6400	3.81E-04	6000	4.33E-04	6050	4.26E-04	6500	3.69E-04	6875	3.30E-04	6900	3.28E-04	13690	8.32E-05	13650	8.37E-05	15260	6.70E-05
	Drills	6 mounted halogen lights	390	7	2730	54600	6400	6.67E-04	6000	7.58E-04	6050	7.46E-04	6500	6.46E-04	6875	5.78E-04	6900	5.73E-04	13690	1.46E-04	13650	1.47E-04	15260	1.17E-04
	Dozers	6 mounted halogen lights	390	5	1950	39000	6400	4.76E-04	6000	5.42E-04	6050	5.33E-04	6500	4.62E-04	6875	4.13E-04	6900	4.10E-04	13690	1.04E-04	13650	1.05E-04	15260	8.37E-05
	Grader	6 mounted halogen lights	390	1	390	7800	6400	9.52E-05	6000	1.08E-04	6050	1.07E-04	6500	9.23E-05	6875	8.25E-05	6900	8.19E-05	13690	2.08E-05	13650	2.09E-05	15260	1.67E-05
Operational Facilities	Mobile Floodlight Tower (4)	4 metal halide lights	4200	6	25200	2772000	6400	3.38E-02	6000	3.85E-02	6050	3.79E-02	6500	3.28E-02	6875	2.93E-02	6900	2.91E-02	13690	7.40E-03	13650	7.44E-03	15260	5.95E-03
	Mobile Floodlight Tower (4)	4 metal halide lights	4200	2	8400	924000	5600	1.47E-02	5500	1.53E-02	5400	1.58E-02	5775	1.39E-02	6025	1.27E-02	6050	1.26E-02	13220	2.64E-03	13160	2.67E-03	15080	2.03E-03
	Crusher (Mobile Equipment)	6 mounted halogen lights	390	1	390	7800	5600	1.24E-04	5500	1.29E-04	5400	1.34E-04	5775	1.17E-04	6025	1.07E-04	6050	1.07E-04	13220	2.23E-05	13160	2.25E-05	15080	1.71E-05
	Pole Mounted Lights (5)	LED roadway lights	75	28	2100	241500	5600	3.85E-03	5500	3.99E-03	5400	4.14E-03	5775	3.62E-03	6025	3.33E-03	6050	3.30E-03	13220	6.91E-04	13160	6.97E-04	15080	5.31E-04
Waste Rock Storage	Mobile Floodlight Tower (4)	4 metal halide lights	4200	2	8400	924000	6100	1.24E-02	4800	2.01E-02	5250	1.68E-02	6250	1.18E-02	6700	1.03E-02	6750	1.01E-02	12320	3.04E-03	12360	3.02E-03	13520	2.53E-03
Haul Route (7)	Hauling Truck (6)	6 mounted halogen lights	390	2	780	15600	100	7.80E-01	2300	1.47E-03	1450	3.71E-03	75	1.39E+00	600	2.17E-02	675	1.71E-02	40	4.88E+00	320	7.62E-02	75	1.39E+00
POST-CURFEW						Total, R1:	6.86E-02	Total, R2:	8.21E-02	Total, R3:	7.88E-02	Total, R4:	6.57E-02	Total, R5:	5.89E-02	Total, R6:	5.84E-02	Total, R7:	-	Total, R8:	-	Total, R9:	-	
PRE-CURFEW						Total, R1:	8.49E-01	Total, R2:	8.21E-02	Total, R3:	7.88E-02	Total, R4:	1.45E+00	Total, R5:	8.06E-02	Total, R6:	7.55E-02	Total, R7:	4.88E+00	Total, R8:	7.62E-02	Total, R9:	1.39E+00	

Notes:

- (1) Unless specified, the average Lumens /Watt used were as follows:
 LED lights typically are 58-113 lumens/ per watt.
 Compact Fluorescent lights are typically 70 lumens/watt.
 Linear Fluorescent lights are typically 108 lumens/watt.
 Incandescent lights are typically 15 lumens/watt.
 Halogen lights are typically 20 lumens/watt.
 High Pressure Sodium lights are typically 108 lumens/watt.
Source: United States Department of Energy, Solid-State Lighting LED Basics <https://energy.gov/eere/ssl/led-basics>
- (2) Illuminance = Luminous Flux/square of distance travelled; therefore 1 Lux = 1 lumen/m2.
- (3) Mobile equipment with headlights was assumed to be stationary for simplicity. It was assumed that each piece of equipment has 6 mounted halogen lamp lights, 65 watts each.
- (4) Atlantic Gold indicated that Generac Magnum MLT3060M floodlight towers will be used on Site. Manufacturer's specification were used to determine a luminous flux of 462,000 lumens. See Appendix A for Mobile Floodlight Tower specifications.
- (5) Illuminance for Pole Mounted Lights based on a 75 W LED light, with a luminous flux of 8625 lumens, typical for site lighting applications. See Appendix A for LED lighting specifications.
- (6) As a worst-case scenario, the light impacts from two trucks were assessed at each receptor along the Haul Route. The trucks were both assumed to be at the closest location to each receptor along the Haul Ro.

Comparison of Light Levels at Receptors with Published Guidelines
Beaver Dam Mine Project
Atlantic Gold Corporation
Marinette, Halifax, Nova Scotia

Receptor	Description	Illuminance (lux)		ILE Guidance Limit (1)		Percentage of Criteria (3)	
				Pre-Curfew (2)	Post-Curfew (2)	Pre-Curfew	Post-Curfew
		Pre-Curfew (2)	Post-Curfew	(lux)	(lux)	(%)	(%)
R1	9 Beaver Dam Mine Road (Debbie Marlborough Property)	8.49E-01	6.86E-02	5	1	16.97%	6.86%
R2	4112 Highway 224 (Beaver Lake IR 17)	8.21E-02	8.21E-02	5	1	1.64%	8.21%
R3	4115 Highway 224 (Cottage on Crownland)	7.88E-02	7.88E-02	5	1	1.58%	7.88%
R4	3492 Highway 224 (Hobbs Property)	1.45E+00	6.57E-02	5	1	29.05%	6.57%
R5	3379 Highway 224 (McLeod Property)	8.06E-02	5.89E-02	5	1	1.61%	5.89%
R6	3373 Highway 224 (Smith Property)	7.55E-02	5.84E-02	5	1	1.51%	5.84%
R7	Tangier River (Deepwood Estates Property)	4.88E+00	-	5	1	97.50%	-
R8	Tangier River (Musquodoboit Lumber Co Ltd. Property/John Dickson Lease)	7.62E-02	-	5	1	1.52%	-
R9	5579 Mooseland Road (Lloy Property)	1.39E+00	-	5	1	27.73%	-

Assumptions:

- (1) Based on an assumed classification of the area as Environmental Zone E2- Low district brightness areas.
Source: Guidance Notes for the Reduction of Obstrusive Light, The Institute of Lighting Professionals (2020).
- (2) Curfew = the time after which stricter requirements for the control of obtrusive light will apply. If not defined by the local planning authority, the ILP suggests 11:00 p.m.
Source: Guidance Notes for the Reduction of Obstrusive Light, "Table 1-Obtrusive Light Limitations for Exterior Lighting Installations", The Institute of Lighting Professionals (2020).
Haul road operations will only occur between 7 AM - 11PM (during Pre-Curfew hours)



Lighting was also considered along the haul route. As a worst-case scenario, the illuminance from two trucks at the closest location on the haul route to each nearby individual sensitive receptor shining light towards each receptor were considered. Other than the hauling trucks, no other lighting sources will be present along the haul route (i.e., street lights, traffic lights). For simplicity, the two trucks were combined as a single stationary source, and were assumed to have six 65 watt halogen lights each.

Lighting will not be installed along the haul road.

4. Sensitive Receptors

The nearest permanent residential receptor to the mine is the Beaver Lake IR 17 (R2), at a distance of approximately 4.6 km southwest from the Beaver Dam Mine Site boundary (Table 1). Five other residential receptors, farther away from the mine and located along Highway 224, are also considered; Marlborough property (R1), the cottage on crownland (R3), the Hobbs property (R4), the McLeod property (R5) and the Smith property (R6). These six residential receptors were mainly used in the analysis of the impacts of light trespass from the mine.

Sensitive receptors were also considered along the proposed Haul Route. Three seasonal residences located within 320 m of the haul route were assessed for light impacts from hauling trucks travelling along the route; the Deepwood Estates property (R7), the Musquodoboit Lumber Co property/John Dickson Lease (R8) and the Lloy property (R9) (Table 1). These three residential receptors were mainly used in the analysis of the impacts of light trespass from transport trucks travelling along the haul route. As previously mentioned, the illuminance from the haul route was evaluated against pre-curfew limits due to the hauling schedule.

Marlborough property (R1), the Hobbs property (R4), McLeod property (R5) and the Smith property (R6) were assessed for impacts of light trespass from both the transport trucks travelling along the haul route during Pre-Curfew Conditions and light trespass from the mine during Pre-Curfew and Post-Curfew conditions.

Figures 1B to 10 show the Site layout and the locations of all these receptors.

5. Method of Assessment

AMNS provided GHD with a list of proposed lighting as indicated in Section 3 of this Report. From known information about the power output of the installations and typical efficiencies, the luminous flux of each light source was calculated:

$$\text{Luminous Flux (lm)} = \text{Power Output (watts)} \times \text{Efficiency} \left(\frac{\text{lumens}}{\text{watt}} \right)$$



The power output of the proposed lighting was known from manufacturer information, and the efficiency was based on typical industry published values, as presented in the following table.

Type of Light	Typical Efficiency (lumens/watt)
LED	58 – 113
Compact Fluorescent	70
Linear Fluorescent	108
Incandescent	15
Halogen	20
High Pressure Sodium	100

Sample Calculation:

There are 4 loaders to be operated around the Open Pit area, each with 6 mounted halogen lights having a power output of 65 watts each and with average efficiencies of 20 lumens/watt. The luminous flux of the trucks can be calculated as follows:

$$Power\ Output = 4\ loaders \times 6 \frac{Lights}{Loader} \times 65 \frac{W}{Light} = 1560\ W$$

$$Luminous\ Flux = 1560\ W \times 20 \frac{lumens}{W} = 31,200\ lumens$$

After determining luminous flux estimates for each light source, the impacts of the incident light at the identified sensitive receptors can be determined. There are four main areas across the Site where lighting is to be located:

1. Open Pit
2. Operational Facilities
3. Waste Rock Storage
4. Haul Route

Table 1 indicates the estimated distance to the sensitive receptors from each of these areas. The illuminance level at a receptor is equal to the combined total from each light source. It has been conservatively assumed that 50 percent of the incident light will not reach the receptor due to the dense tree cover at the Site and surrounding area. The following equation was used to estimate the illuminance contribution from each light source:

$$E = \frac{\phi}{d^2} \times 50\%$$

Where:

E = illuminance (lux).

ϕ = luminous flux (lm).

d = distance to the receptor (m).



Sample Calculation:

The luminous flux from the four loaders at the open pit is an estimated 31,200 lm. The distance to the Beaver Lake IR receptor from the open pit is approximately 5,000 m. The illuminance contribution from the loaders to the Beaver Lake IR receptor can be estimated as follows:

$$\text{Illuminance} = \frac{31,200 \text{ lumens}}{(5000 \text{ m})^2} \times 50\% = 6.24 \times 10^{-4} \text{ lux}$$

This method was used to determine the estimated illuminance at each receptor from each of the light sources. The sum of all contributions for each receptor represents the total estimated level of light that will be present at the receptor.

For the purposes of this assessment, "pre-curfew" was assumed to be before 11 PM and included road activity as well as Beaver Dam Mine activities. "Post-curfew" was between 11 PM and 7 AM and included only overnight activities at the Beaver Dam Mine Site. The summary of results from the Light Impact Assessment is provided in the results section below and Table 2. The assessment of light impacts along the Haul Road was completed by considering a "worst case" scenario when two trucks are closest to each receptor and shining light towards the receptor. Because receptors along the Haul Road are not located on any road bends, with limited line of site to the travelling trucks, the assessed light impacts to these receptors were likely overestimated.

A cumulative effects assessment of light considers anticipated haul traffic from Fifteen Mile Stream (FMS) Gold Project and the Cochrane Hill (CH) Gold Project. During the operation phase of the FMS and CH Projects, gold concentrate mines will be transported to the Touquoy processing site for final processing into gold doré bar. The proposed haul route for each project may overlap with the Beaver Dam Mine Haul Road west of the Highway 224, along with trucking activity associated with the forest industry (Northern Timber). Eleven round-trips are proposed to carry gold concentrate from each of the FMS and CH Projects per day (totaling 22 vehicle round-trips per day or 44 1-way trips), plus 95 round-trips per day (or 190 1-way trips) between Beaver Dam and Touquoy.

Based on communications with Northern Timber regarding their lumbering operations (forestry), it has been confirmed that forestry operations may add approximately 925 truck trips per year and an additional 3000 service trucks per year for maintenance, of which 80% are estimated to occur in the spring and fall (Northern Timber pers comm). To account for these additional vehicles, a further 12 truck trips per day have been added to the total, but it is clear that forestry will not be a significant source of traffic on the Haul Road. The operation of the Beaver Dam Mine Project, the Fifteen Mile Stream Gold Project and the Cochrane Hill Gold Project are proposed roughly to occur during the same time from 2023 to 2027. During this time all three projects will use the portion of the Beaver Dam Haul Road west of Highway 224 to transport ore (Beaver Dam Mine) and concentrate (FMS and CH) to the Touquoy Mine. The FMS and CH projects will use the portion of the Beaver Dam Haul Road west of the Highway 224 to transport gold concentrate to the Touquoy Mine Site whereas the Beaver Dam project will use the entire haul road to transport ore bearing rock to the Touquoy Mine Site. Given the limitations of traffic on the Beaver Dam Haul Road (2 lanes, only 2 trucks can be in one place at one time), the 10% increase in volume of traffic due FMS and CH Mine operations will not result in a cumulative impact on light levels, particularly related to light levels on receptors.



6. Results and Discussion

Table 1 provides a summary of the light sources at the Site, and the expected impacts from each source on the receptors. The combined effects of all the applicable sources during Pre-Curfew as well as Post-Curfew at each receptor were summed and compared to the illuminance limits recommended by the ILP (2020), as shown in Table 2. Table 3 shows total luminous flux from the Beaver Dam Mine and Haul Road, along with distance to the 5.0 lux and 1.0 lux assessment criteria. Furthermore, Table 3 also shows the distance to a maximum 0.1 lux illuminance level which is considered as background light level for this assessment. The 0.1 Lux light level is the maximum illuminance assessment criteria during post-curfew for the environmental zone E1 which is considered a natural, relatively uninhabited rural area such as national parks and areas of outstanding natural beauty.

Figure 1A shows the Light shed map as per the requirement of CEAA 2-05 in consideration of Beaver Dam IR 17 and areas identified for current use practices and shows Light Trespass from Beaver Dam Mine and Haul Road Traffic.

The light shed map (Figure 1A) shows that the light levels from the Beaver Dam Mine Site reach maximum 5 Lux at a distance of 719 m from the source, maximum 1 Lux light level at distance of 1,607 m from the source and maximum 0.1 Lux (background level) at a distance of 5082 m from the source. Table 3 and Figure 1A also show that during Pre-Curfew conditions when the haul road is in operation, when two trucks pass the same point simultaneously, the ambient light may be 5 lux or more out to a maximum distance of 39 m from the haul road (on an instantaneous basis, this will not be a continuous light level, it will occur only where two trucks are passing each other, and only for the brief period they are both affecting the same receptor). At a distance of 279 m, the light under these same conditions will be less than 0.1 lux (or less than background).

Receptors R1, R4, R5 to R6 are located close to the Mine and Haul Road light sources and therefore these receptors have been assessed for light originating from both the Beaver Dam Mine and Haul Road for the Pre-Curfew conditions and only Mine lights for the post-curfew conditions. Receptors R2 and R3 were assessed for light originating from Beaver Dam Mine during Pre-Curfew and Post Curfew conditions. Receptor R7, R8 and R9 were only assessed for light from Haul Road during Pre-Curfew conditions.

The results presented on Table 2 and Figure 1A show that none of the ILP Guidance Light Limits (Pre-Curfew or Post Curfew) is exceeded at any of these receptors during both Pre-Curfew and Post-Curfew. It is expected that Receptors R1 – R6 may observe light impacts from the Beaver Dam Mine Project equaling at least an order of magnitude less than 1 Lux light levels during Post-Curfew conditions and at least an order of magnitude less than 5 Lux during Pre-Curfew conditions.

Furthermore, Table 2 and Figure 1A show that Receptors R7, R8 and R9 which are located close to the haul road will not experience any exceedances of ILP Guide light standard of 5 Lux during Pre-Curfew conditions (ILP 2020). It is to be noted that no haul road operations will occur during Post-Curfew conditions. Figure 1A also shows that these receptors will not be impacted by lights originating from Beaver Dam Mine itself as the light from Beaver Dam reaches background level at 5,082 m from the light source.



Table 3

**Distance to Sky Glow Dissipation
Beaver Dam Mine Project
Atlantic Gold Corporation
Marinette, Halifax, Nova Scotia**

	Total Luminous Flux (Lumens)	Distance to Below 5.0 Lux (m)	Distance to Below 1.0 Lux (m)	Distance to Below 0.1 Lux (m)
Beaver Dam Mine (based on 50% Incident light)	5165700	719	1607	5082
Haul Road (based on 50% Incident light)	15600	39	88	279

Notes:

1.0 Lux is approximately the brightness of a full moon under clear sky.

0.1 Lux is less bright than the full moon, but brighter than a moonless night.

On particularly overcast nights, sky glow may be visible farther due to reflection from low cloud cover



The calculated light levels at the identified sensitive receptors are below the limits recommended by the ILP guidelines during both post- and pre-curfew conditions, as shown in Table 2.

The predicted illuminance levels represent the worst-case operating conditions of the mine. The assessment considers all the mobile equipment at the mine would be in use at the same time, illuminating towards receptors. The areas surrounding the Site are wooded with varying topography and inhibit the spread of light. It was conservatively assumed for screening purposes that 50 percent of the light will not reach the receptors due to directionality and line of sight obstructions. The amount of light blocked by the surrounding woodland and topographic changes, however, will likely be much greater than this (i.e., >90 percent), especially during the seasons when deciduous trees are leaf-on.

The additional service truck round trips along the Haul Road are not anticipated to change the assessment results. The worst-case would still occur when two trucks are close to a single receptor and shining lights toward that receptor. As the road is only 2 lanes, only two trucks could approach a receptor at one time (one from each direction). During daylight hours, the truck lights are insignificant compared to ambient light levels, in the dawn, dusk and evening hours (until 11 PM when curfew is implemented), potential light impacts will be as presented in Table 1.

In a previous assessment under a separate cover, light impacts from the Touquoy Processing Plant were assessed against limits recommended by the ILP guidelines (2020). This assessment determined that light impacts from the Touquoy facility were also below the ILP limits. Although the light impacts from the Touquoy facility and Beaver Dam Mine were not evaluated in combination, it is expected that the ILP limits at nearby receptors will not be exceeded from light trespass at both facilities. This is expected due to the low illuminance levels assessed at each receptor in both assessments and due to the large distances from the receptors to the sources of light at the other facilities.

7. Best Management Practices

Best management practices can minimize the light pollution incurred during the daily operation of a facility. AMNS has indicated that floodlights on site will employ a "full horizontal cut off". A full horizontal cut off allows no direct light emissions above a horizontal plane through the luminaire's lowest light emitting part. This practice has been shown to significantly reduce light trespass in other applications. Where possible, all lighting fixtures will be facing towards the working area at the Site, to limit obtrusive light "spill" to nearby receptors. Also, AMNS has indicated that lighting not being utilized will be turned off when practical.

The majority of the light fixtures to be used on site will utilize LED Light. This is one of the more energy efficient types of light, yielding significantly more lumens per watt than traditional halogen and incandescent bulbs, in addition to having a longer lifespan. Where possible, AMNS will choose energy efficient for light replacements or additions.

Routine monitoring of the light levels at the Site, once constructed and operational, using a light meter will provide an opportunity to monitor light levels. More refined light level measurements could assist in further quantifying the effects of light sources on the sensitive receptors.



8. References

AMNS (Atlantic Mining NS Inc.). 2021. Beaver Dam Mine Project Updated Environmental Impact Assessment. 2021.

CEAA (Canadian Environmental Assessment Agency). 2016. Guidelines for the Preparation of an Environmental Impact Statement. Pursuant to the *Canadian Environmental Assessment Act*, 2012 and Nova Scotia Registration Document pursuant to the *Nova Scotia Environment Act*. Beaver Dam Mine. Atlantic Gold Corporation. January 2016.

GHD. 2017. Light Impact Assessment. Beaver Dam Mine Project, Marinette, Nova Scotia. Prepared for the Atlantic Gold Beaver Dam Mine Project Revised Environmental Impact Statement – February 28, 2019, Appendix D.1. Prepared by GHD. December 17, 2017.

ILP (Institute of Lighting Professionals). 2020. Guidance Note 01/20: Guidance Note for the Reduction of Obtrusive Light.

Figures

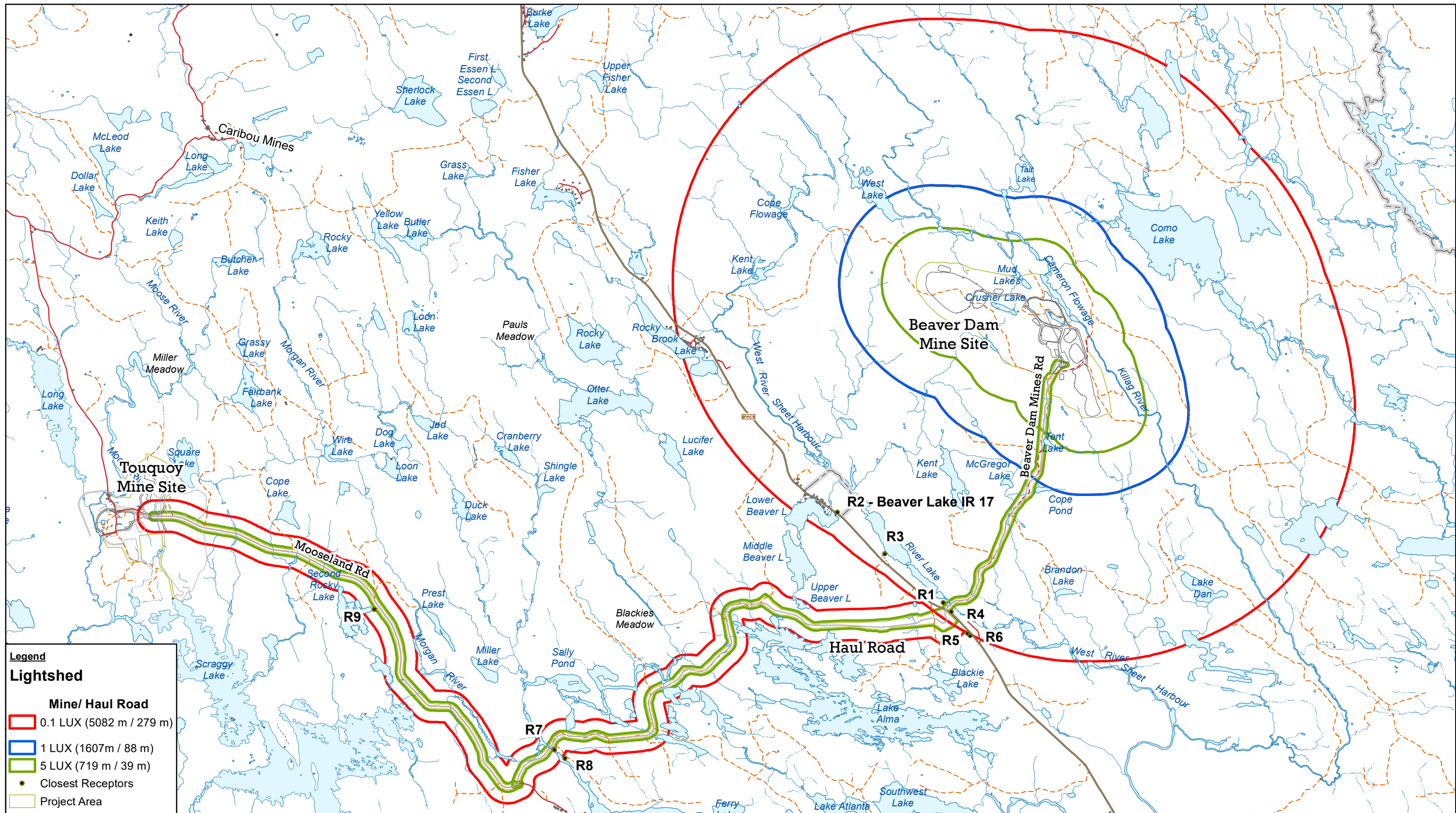

Source: Service Nova Scotia, GHD

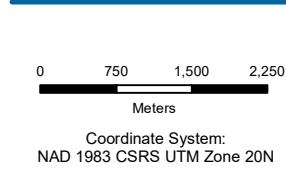

Map shows light trespass from Beaver Dam Mine and Haul Road traffic only. Light trespass from (existing) Touquoy Mine is not presented.



ATLANTIC GOLD CORPORATION
MARINETTE, HALIFAX CO., NOVA SCOTIA
ENVIRONMENTAL IMPACT STATEMENT - BEAVER DAM MINE
LIGHT IMPACT FROM BEAVER
DAM MINE AND HAUL ROAD

088664 (014)
Dec 3, 2020

FIGURE 1A

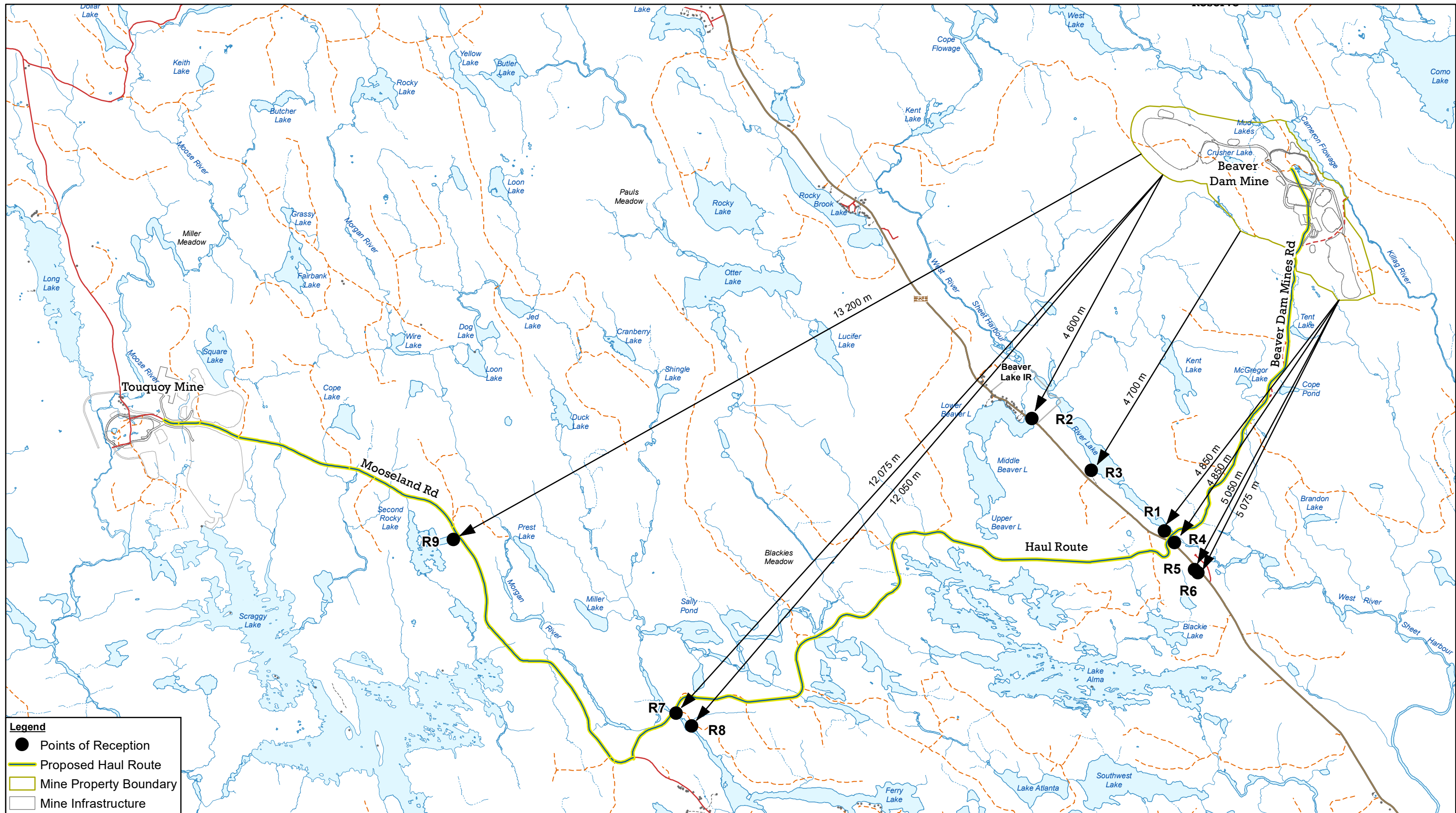

Legend

- Points of Reception
- Proposed Haul Route
- ▭ Mine Property Boundary
- ▭ Mine Infrastructure

Source: Insert source text here.

0 600 1,200 1,800
Meters

Coordinate System:
NAD 1983 CSRS UTM Zone 20N



ATLANTIC GOLD CORPORATION
MARINETTE, HALIFAX CO., NOVA SCOTIA
ENVIRONMENTAL IMPACT STATEMENT - BEAVER DAM MINE

088664 (017)
Dec 2, 2020

SITE AND POINT OF RECEPTION LOCATION PLAN

FIGURE 1B

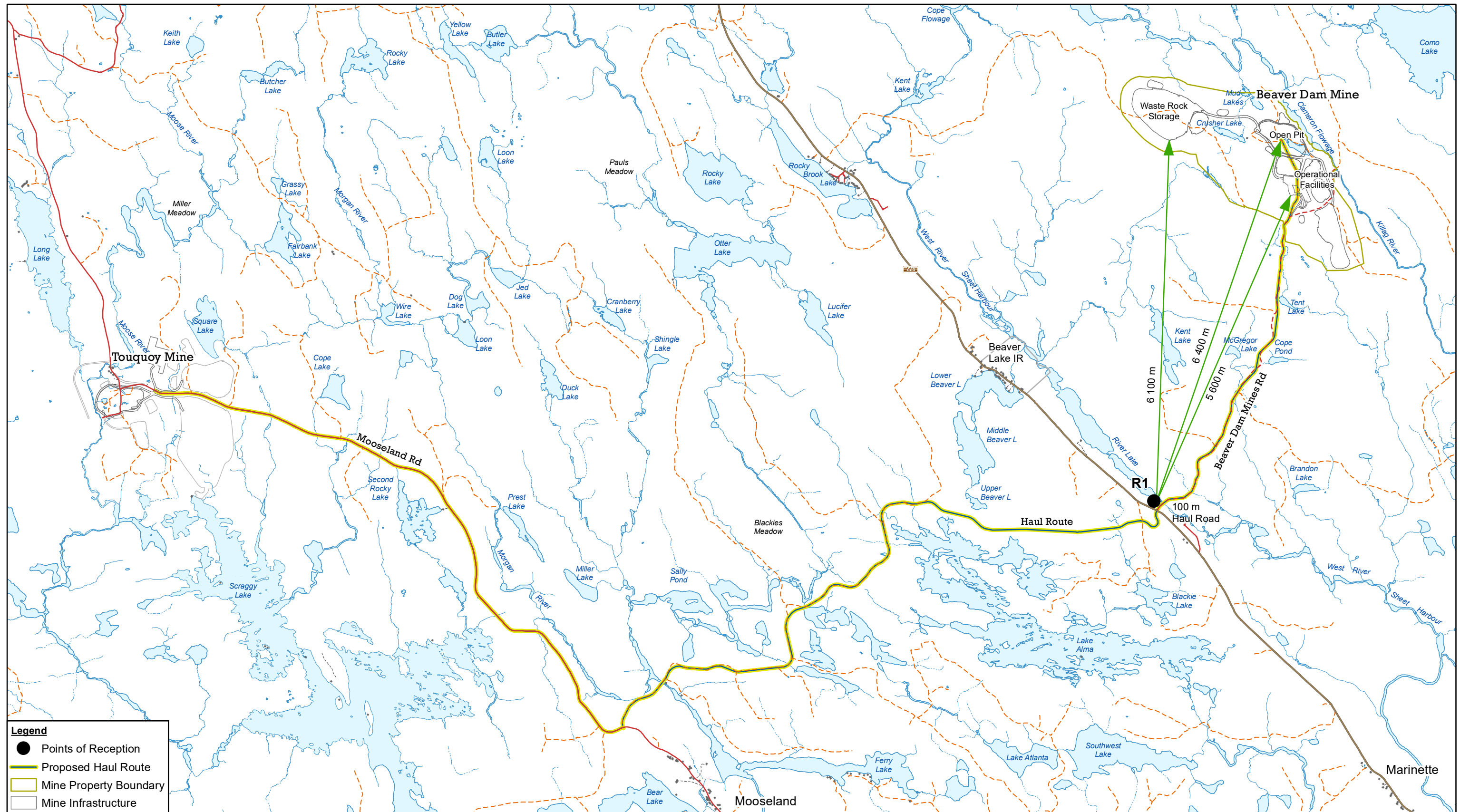

Legend

- Points of Reception
- Proposed Haul Route
- - - Mine Property Boundary
- ▭ Mine Infrastructure

Source: Insert source text here.

0 600 1,200 1,800
Meters

Coordinate System:
NAD 1983 CSRS UTM Zone 20N



ATLANTIC GOLD CORPORATION
MARINETTE, HALIFAX CO., NOVA SCOTIA
ENVIRONMENTAL IMPACT STATEMENT - BEAVER DAM MINE
LIGHT SOURCE AND RECEPTOR SEPARATION
DISTANCE PLAN - R1

088664 (017)
Dec 2, 2020

FIGURE 2

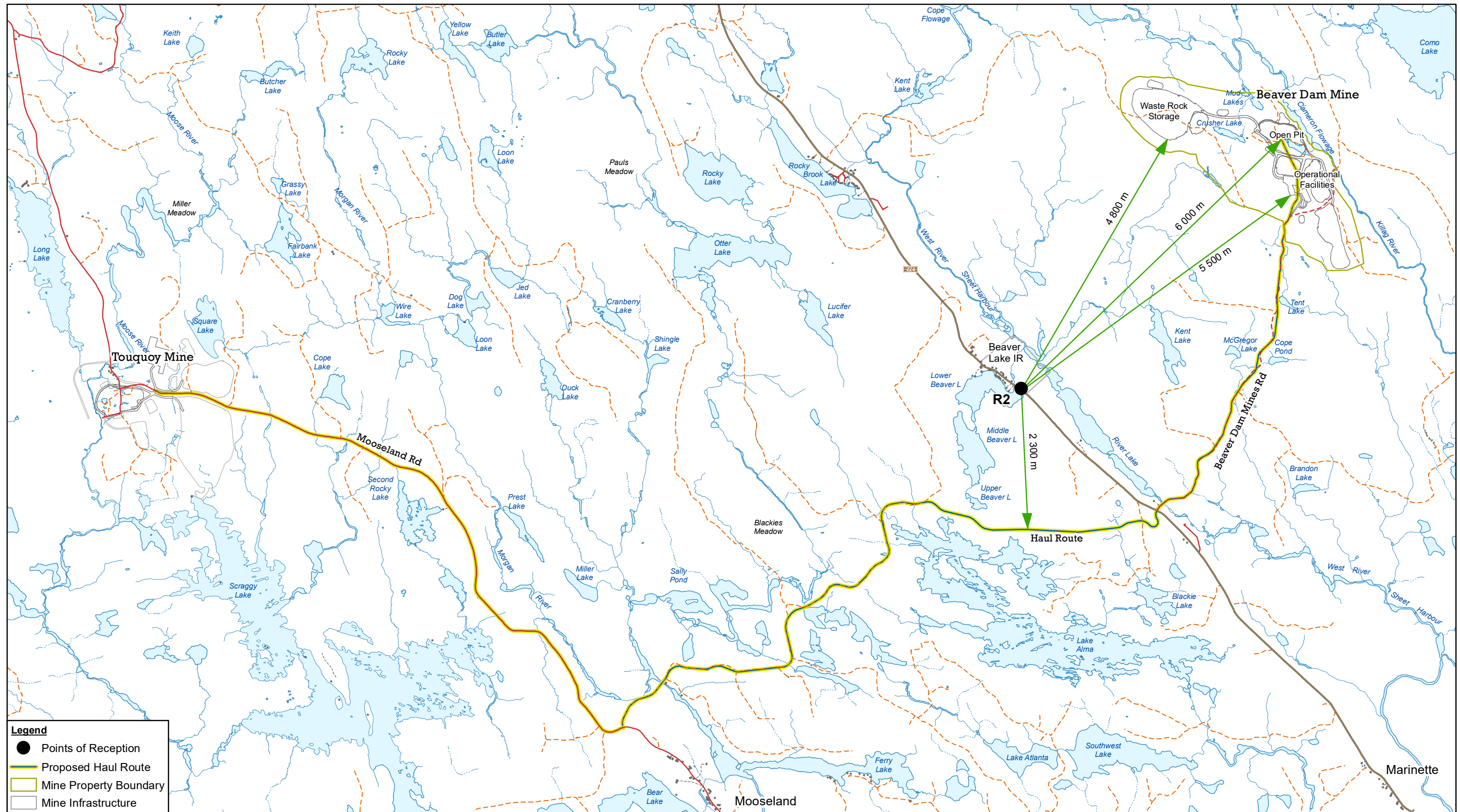

Source: Insert source text here.

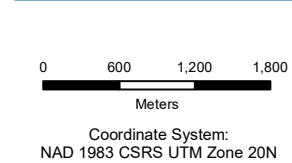

ATLANTIC GOLD CORPORATION
MARINETTE, HALIFAX CO., NOVA SCOTIA
ENVIRONMENTAL IMPACT STATEMENT - BEAVER DAM MINE
LIGHT SOURCE AND RECEPTOR SEPARATION
DISTANCE PLAN - R2

088664 (017)
Dec 2, 2020

FIGURE 3

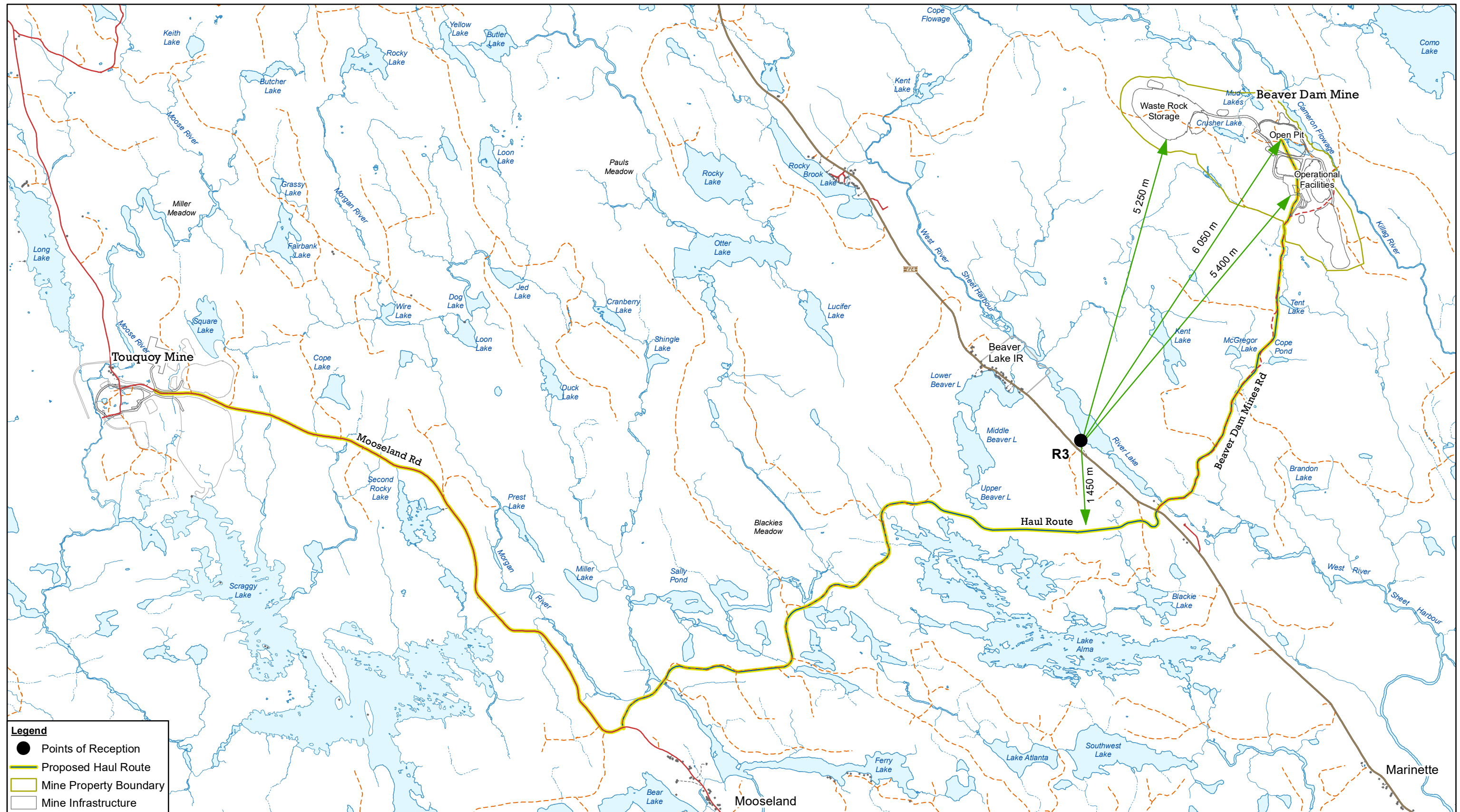

Legend

- Points of Reception
- Proposed Haul Route
- - - Mine Property Boundary
- ▭ Mine Infrastructure

Source: Insert source text here.

0 600 1,200 1,800
Meters

Coordinate System:
NAD 1983 CSRS UTM Zone 20N



ATLANTIC GOLD CORPORATION
MARINETTE, HALIFAX CO., NOVA SCOTIA
ENVIRONMENTAL IMPACT STATEMENT - BEAVER DAM MINE
LIGHT SOURCE AND RECEPTOR SEPARATION
DISTANCE PLAN - R3

088664 (017)
Dec 2, 2020

FIGURE 4

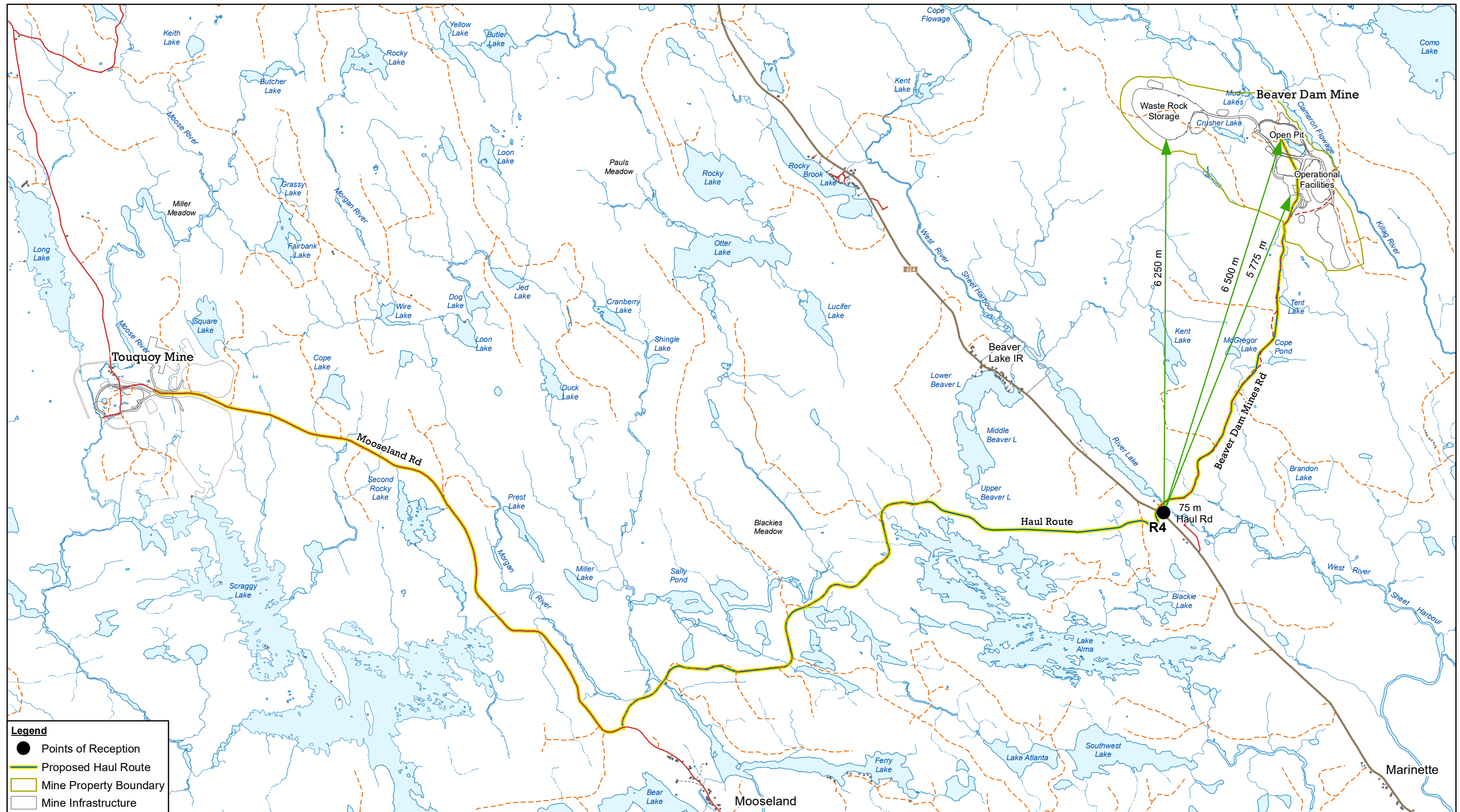

Source: Insert source text here.

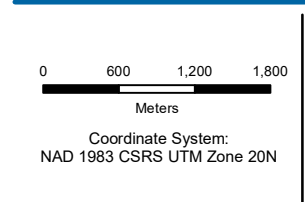

ATLANTIC GOLD CORPORATION
MARINETTE, HALIFAX CO., NOVA SCOTIA
ENVIRONMENTAL IMPACT STATEMENT - BEAVER DAM MINE
LIGHT SOURCE AND RECEPTOR SEPARATION
DISTANCE PLAN - R4

088664 (017)
Dec 2, 2020

FIGURE 5

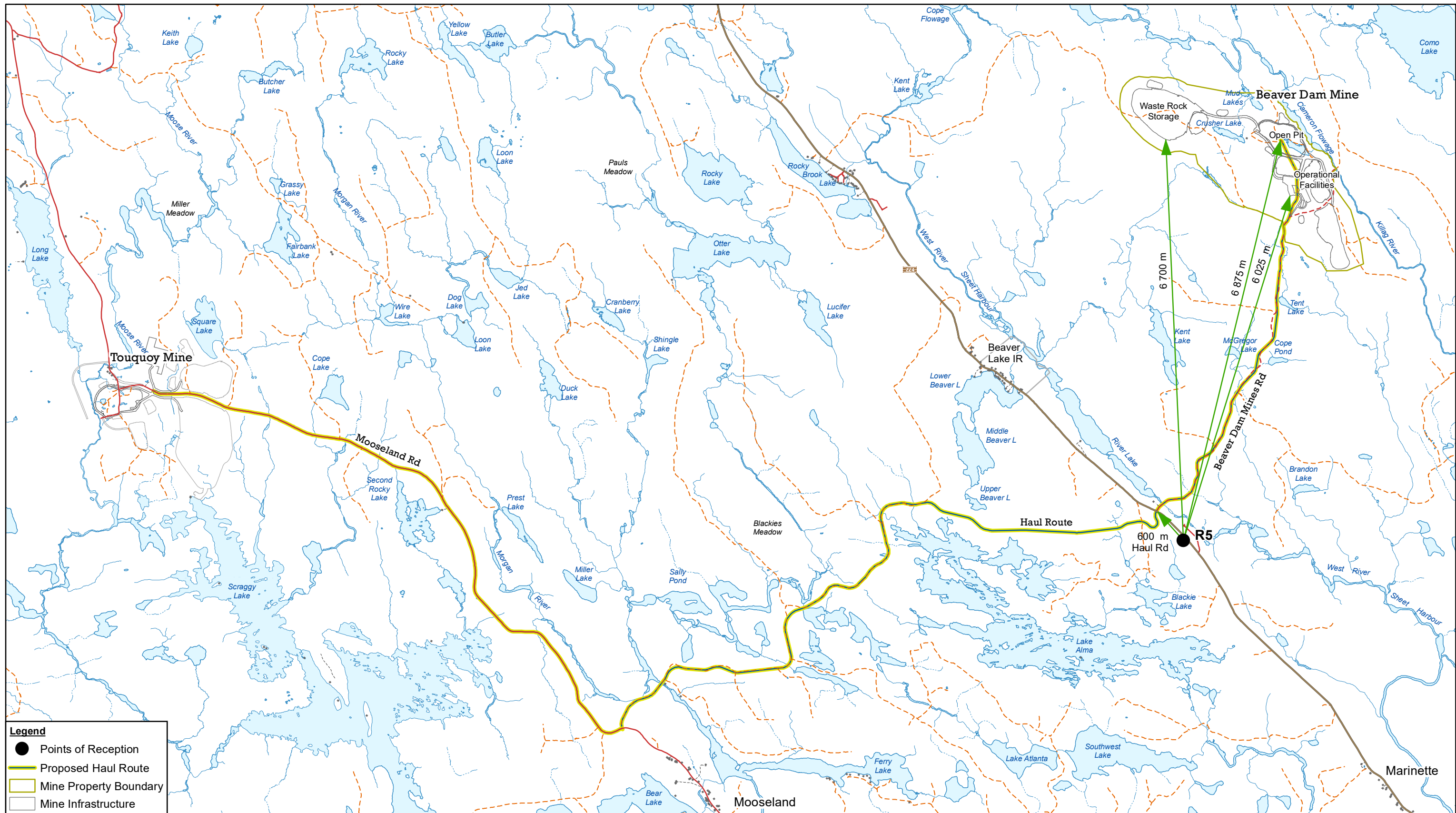

Source: Insert source text here.

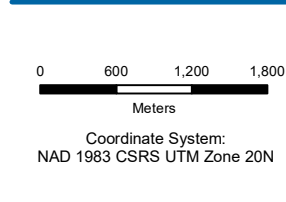

ATLANTIC GOLD CORPORATION
MARINETTE, HALIFAX CO., NOVA SCOTIA
ENVIRONMENTAL IMPACT STATEMENT - BEAVER DAM MINE
LIGHT SOURCE AND RECEPTOR SEPARATION
DISTANCE PLAN - R5

088664 (017)
Dec 2, 2020

FIGURE 6

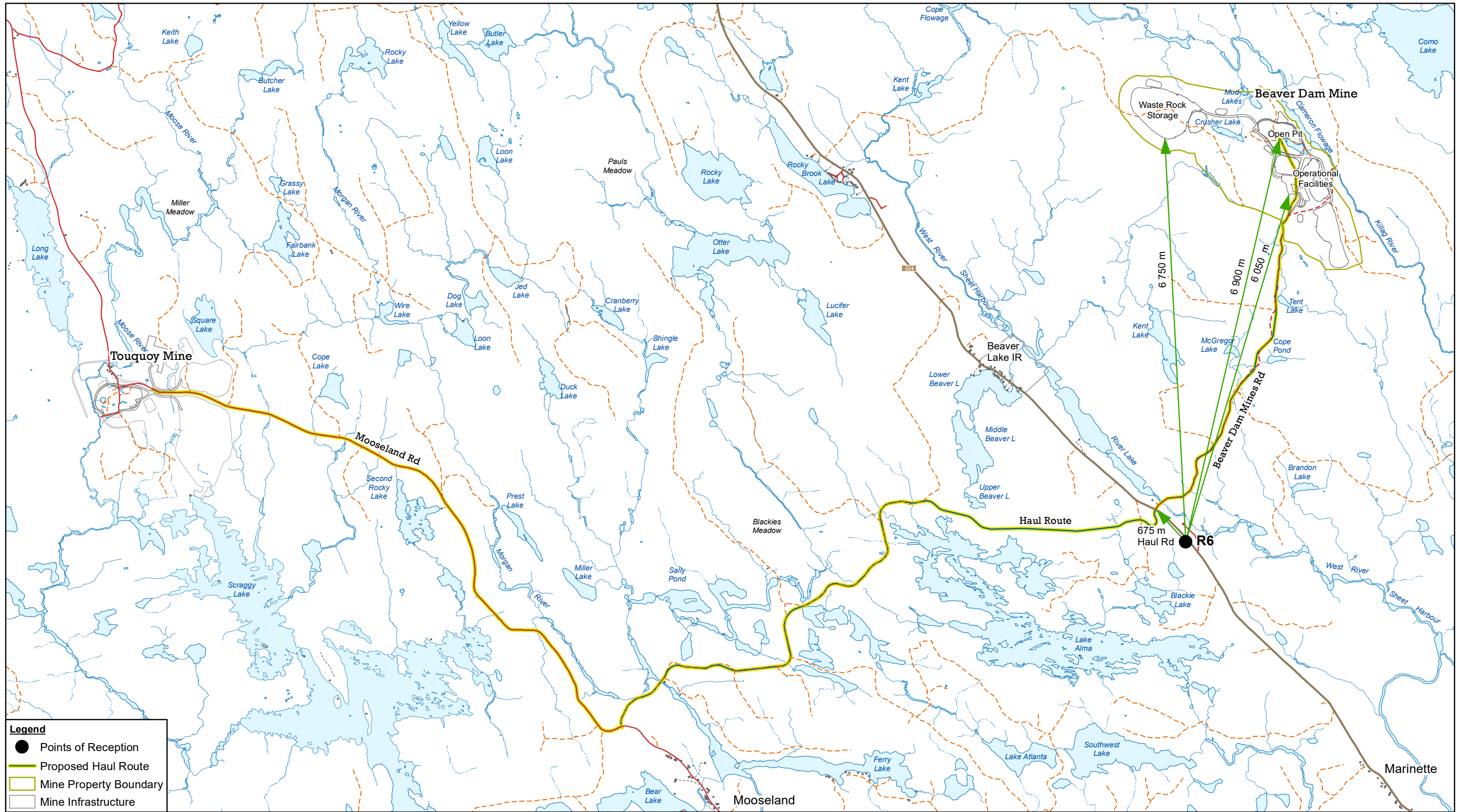

Legend

- Points of Reception
- Proposed Haul Route
- - - Mine Property Boundary
- ▭ Mine Infrastructure

Source: Insert source text here.

0 600 1,200 1,800
Meters

Coordinate System:
NAD 1983 CSRS UTM Zone 20N



ATLANTIC GOLD CORPORATION
MARINETTE, HALIFAX CO., NOVA SCOTIA
ENVIRONMENTAL IMPACT STATEMENT - BEAVER DAM MINE
LIGHT SOURCE AND RECEPTOR SEPARATION
DISTANCE PLAN - R6

088664 (017)
Dec 2, 2020

FIGURE 7

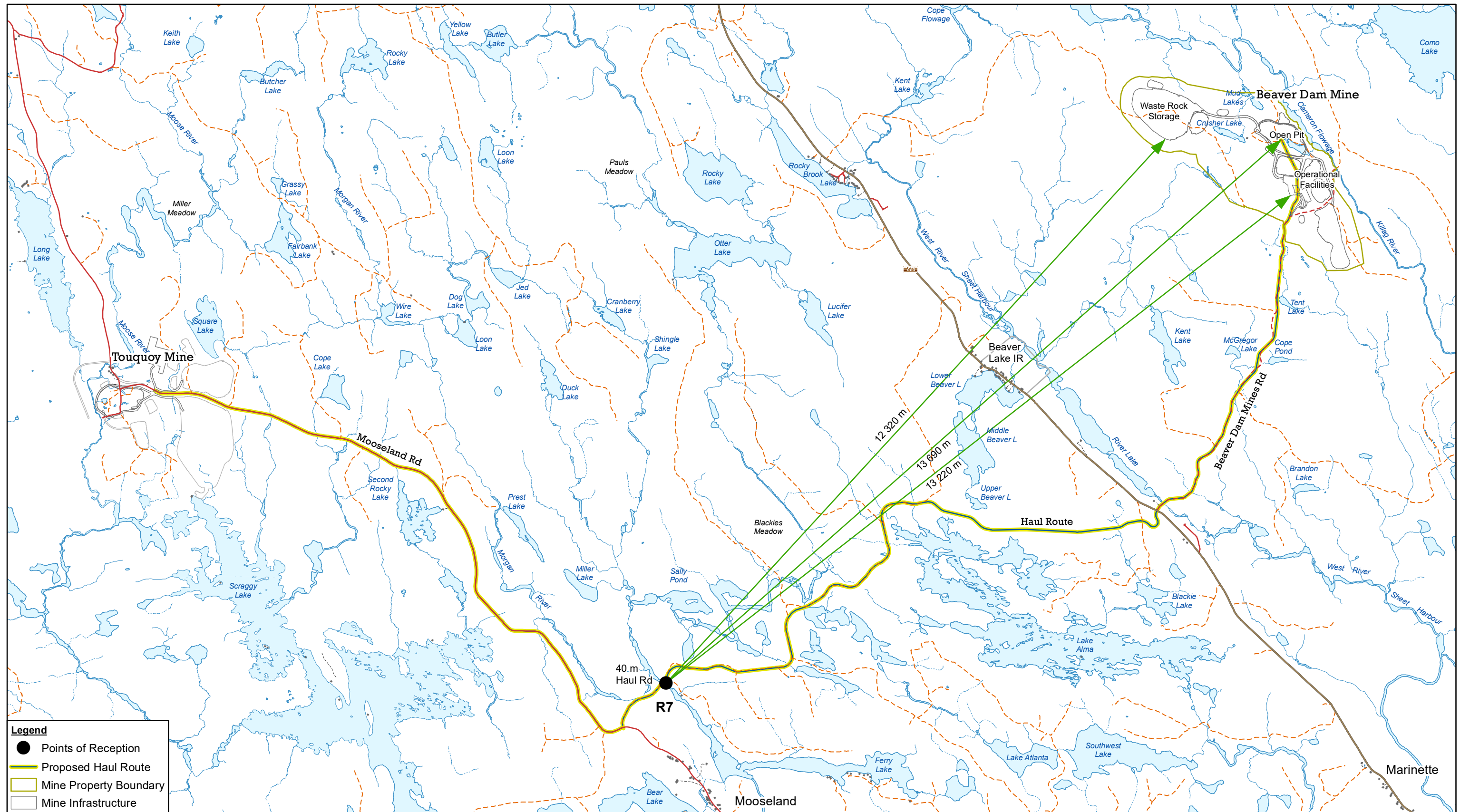

Source: Insert source text here.

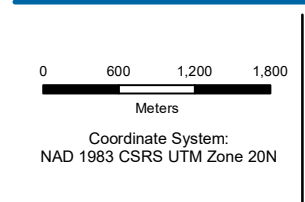

ATLANTIC GOLD CORPORATION
 MARINETTE, HALIFAX CO., NOVA SCOTIA
 ENVIRONMENTAL IMPACT STATEMENT - BEAVER DAM MINE
 LIGHT SOURCE AND RECEPTOR SEPARATION
 DISTANCE PLAN - R7

088664 (017)
 Dec 2, 2020

FIGURE 8

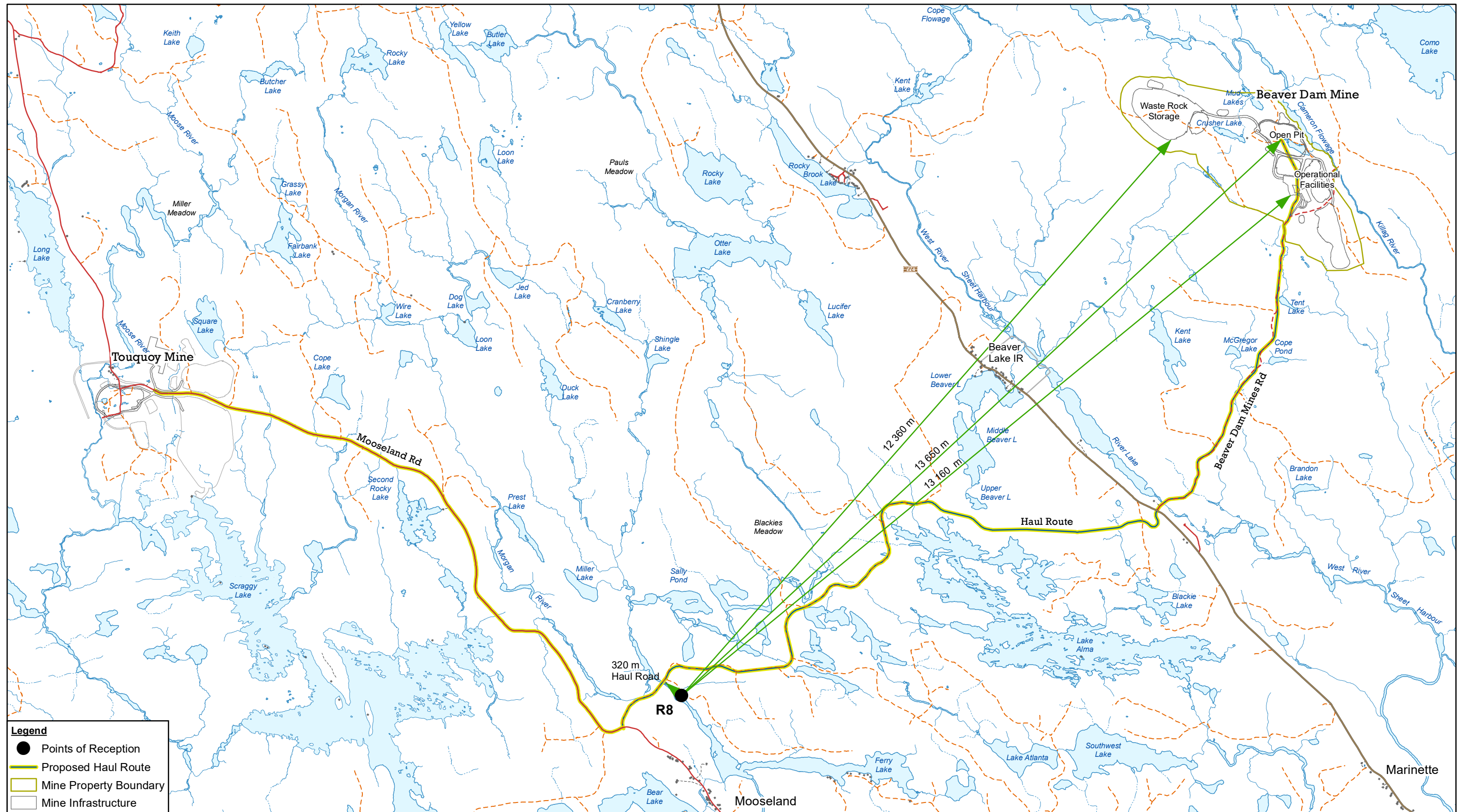

Source: Insert source text here.

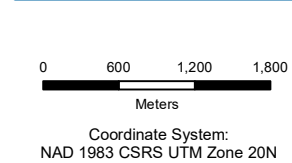

ATLANTIC GOLD CORPORATION
MARINETTE, HALIFAX CO., NOVA SCOTIA
ENVIRONMENTAL IMPACT STATEMENT - BEAVER DAM MINE
LIGHT SOURCE AND RECEPTOR SEPARATION
DISTANCE PLAN - R7

088664 (014)
Dec 2, 2020

FIGURE 9

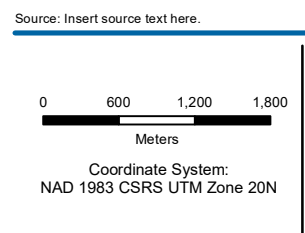
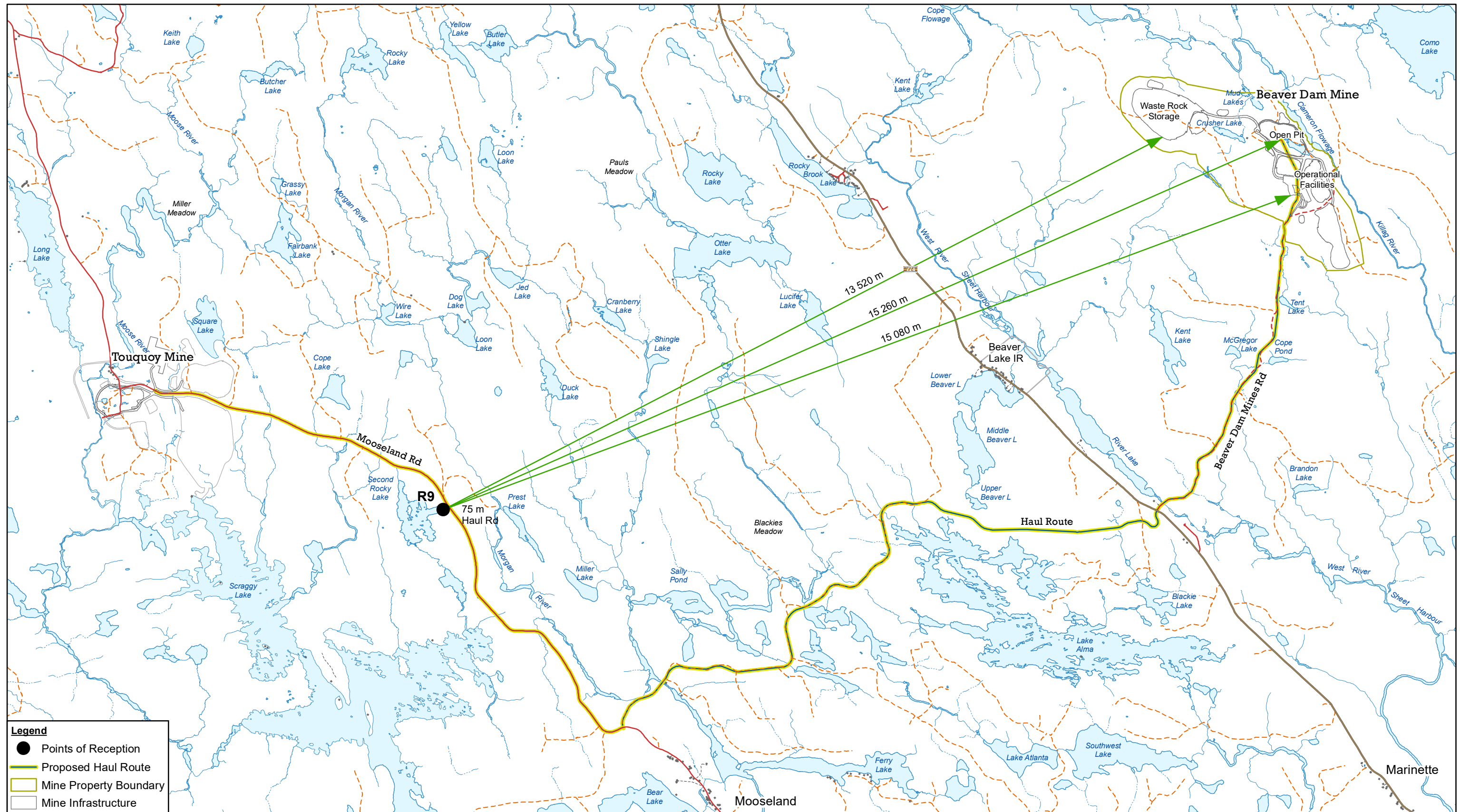

ATLANTIC GOLD CORPORATION
 MARINETTE, HALIFAX CO., NOVA SCOTIA
 ENVIRONMENTAL IMPACT STATEMENT - BEAVER DAM MINE
 LIGHT SOURCE AND RECEPTOR SEPARATION
 DISTANCE PLAN - R9

088664 (017)
 Dec 2, 2020

FIGURE 10

Appendix A

Supporting Information

ENGINE

- Mitsubishi® L3E-W461ML - liquid cooled, diesel engine; Final Tier 4
 - Standby - 12.2 hp @ 1800 rpm
 - Prime - 10.5 hp @ 1800 rpm
 - 3 cylinder
 - 0.95 L displacement
- Polyethylene Fuel Tank:
 - Fuel Type: Diesel
 - Fuel Capacity: 33.6 gal. (127.9 L)
 - 3.5 in. (88.9 mm) fill port
- Fuel Consumption:
 - Full Load: 0.47 gph (1.78 Lph)*
 - Lights Only: 0.24 gph (1.78 Lph)*
 - Maximum Runtime (Lights Only): 140 hours*
- 60 Hz engine/generator
- Cooling system capable of operating at 120°F (49°C) ambient
- 750 hour service interval**
- Full flow oil filter, spin on type
- Fuel filter with replaceable element
- Dry type cartridge air filter
- Wind Rating: 65 mph (105 kph)

**Results based on engine manufacturer and field test data after 100-hour engine break-in period and may vary based on factors including age and maintenance of equipment, environmental conditions and fuel density. Consult the Owner's Manual for fuel and maintenance recommendations.*

***To achieve maximum service interval, replacement of oil filter after 50-hour break-in period is required. Consult Owner's Manual for required oil filter model number.*



GENERATOR

- Marathon Electric®
 - Brushless
- 6 kW standby output
- 120/240 VAC – 50/25A
- +/-6% capacitor voltage regulation

ENGINE CONTROLS

- Engraved, aluminum punched and anodized control panel
- Four position keyed switch – glow plugs (preheat, off, run, start)
- Hour meter
- Automatic low oil/high temperature shutdown system

ELECTRICAL AND SYSTEM CONTROLS

- Individual floodlight circuits with 15A breakers
- Ballast indicator lights
- 30A start limit breaker (assures no load condition exists before starting)
- Standard individually breakered convenience outlets:
 - (1) 120 VAC 20 Amp GFCI duplex outlets (NEMA 5-20R type)
 - (1) 240 VAC 30 Amp Twistlock outlets (NEMA L6-30R type)
- 440CCA wet cell battery

FLOODLIGHTS

- Four (4) 1050 watt metal halide; 462,000 total lumens
- Oval aluminum reflector
- Tempered glass lens
- Silicone gaskets for moisture and dust protection
- Friction disc mounting for tool less positioning
- Individual floodlight On/Off switches

MAST

- Horizontal mast; 30 ft. (9.14 m) maximum extension, 3-section
- Tubular steel frame – 3 in. (76.2 mm) square tube with 3/16 in. (4.78 mm) wall
- Urethane guides on all sides of mast tubes
- Industrial black powder coat finish
- Dual winch system located at ergonomic height allowing single person operation
- 359° ground-level rotation with locking system
- Coiled mast cord

ENCLOSURE

- Steel enclosure – 14-gauge
 - UV & fade resistant, high temperature cured, white polyester powder paint
 - 68 dB(A) at 23 ft. (7 m) – prime power
- Stainless steel hinges on doors
- Multi-lingual operating/safety decals
- License plate holder with light
- Manual holder with operating manual
- Equipped with single lifting eye and fork pockets

TRAILER

- Removable tongue – 48 in. (1219.20 mm) long
- (4) 2000 lb. (907.18 kg) adjustable leveling jacks – 4 point stance
- All jacks transport and lock in horizontal position for storage
- Side outriggers – 96.25 in. (2.45 m) span
- 7800 lb. (3538 kg) safety chains with spring loaded safety hooks
- 2 in. (50.8 mm) ball hitch
- Single wall polyethylene fenders
- DOT approved tail, side, brake, and directional lights
 - Recessed rear lights
- 2200 lb. (997.90 kg) leaf spring axle
- ST175/80D13 – 6 ply
- 40.75 in. (1035.05 mm) axle span

WEIGHT & DIMENSIONS

- Dry weight: 1640 lbs. (744 kg)
- Operating weight: 1856 lbs. (842 kg)
- Mast stowed: 170 x 49 x 68 in. (4.32 x 1.25 x 1.73 m)

WARRANTY

2 Years / 2000 Hours

CERTIFICATIONS

CSA Certified

OPTIONS

Contact sales representative or factory for a list of current available options.

For more information, consult the Owner's Manual at <http://www.generacmobileproducts.com/resources-tools/manuals>

naturalLED®

Turning Light into Savings ▶▶▶



SAL Slim Area Light

29W, 50W, 75W, 100W
180W, 240W, 360W

naturalLED® Slim Area Light constructed with durable, die-cast aluminum housing and excellent thermal design. Our SAL series are low profile replacements for up to 1,000 watt existing Metal Halide and HPS area lighting. Our SAL features a high efficiency LED driver with high lumens and long life LED chip. With excellent optical design improves light distribution and evenness. Perfect for parking lots, streets, walkways, streetscape, and providing you with uniform and consistent color.

Our fixtures are DLC 4.0 Premium and IP65 rated with four installation methods including: Swivel Bracket, Slip Fitter, 6" Extruded Arm and Yoke Mount. Compatible Integrated autonomous and photocell motion sensors are available as options to address your needs.



Key Features & Benefits

- ▶ DLC 4.0 Premium
- ▶ IP65
- ▶ Uniform and consistent color
- ▶ Aluminum die cast housing
- ▶ Excellent thermal design
- ▶ CRI:70
- ▶ Universal Voltage 120-277V
- ▶ Operating Temp: -22°F~122°F
- ▶ 50,000 Hours rated average life
- ▶ 1-10V dimming
- ▶ Motion sensor compatible
- ▶ Photocell sensor compatible

Applications

- ▶ Parking Lot Lighting
- ▶ Street Lighting
- ▶ Site Lighting
- ▶ Streetscape Lighting
- ▶ Area Lighting

2 Color Choices





















































































































































Dark Bronze





























White

Qualifications



Item Code	Description	Color Temp	Wattage	Lumen Output	Equivalent Wattage	Voltage (V)	CRI	Beam Angle	Color			
29W - 100W												
7616	LED-FXSAL29/40K/DB/3S	4000K	29	3190	100-150	120-277	70	Type 3	Dark Bronze			
7617	LED-FXSAL29/50K/DB/3S	5000K	29	3190	100-150	120-277	70	Type 3	Dark Bronze			
7618	LED-FXSAL29/40K/WH/3S	4000K	29	3190	100-150	120-277	70	Type 3	White			
7619	LED-FXSAL29/50K/WH/3S	5000K	29	3190	100-150	120-277	70	Type 3	White			
7620	LED-FXSAL50/40K/DB/3S	4000K	50	5750	250	120-277	70	Type 3	Dark Bronze			
7621	LED-FXSAL50/50K/DB/3S	5000K	50	5750	250	120-277	70	Type 3	Dark Bronze			
7622	LED-FXSAL50/40K/WH/3S	4000K	50	5750	250	120-277	70	Type 3	White			
7623	LED-FXSAL50/50K/WH/3S	5000K	50	5750	250	120-277	70	Type 3	White			
7624	LED-FXSAL75/40K/DB/3S	4000K	75	8625	250-400	120-277	70	Type 3	Dark Bronze			
7625	LED-FXSAL75/50K/DB/3S	5000K	75	8625	250-400	120-277	70	Type 3	Dark Bronze			
7626	LED-FXSAL75/40K/WH/3S	4000K	75	8625	250-400	120-277	70	Type 3	White			
7627	LED-FXSAL75/50K/WH/3S	5000K	75	8625	250-400	120-277	70	Type 3	White			
7628	LED-FXSAL100/40K/DB/3S	4000K	100	12000	400	120-277	70	Type 3	Dark Bronze			
7629	LED-FXSAL100/50K/DB/3S	5000K	100	12000	400	120-277	70	Type 3	Dark Bronze			
7630	LED-FXSAL100/40K/WH/3S	4000K	100	12000	400	120-277	70	Type 3	White			
7631	LED-FXSAL100/50K/WH/3S	5000K	100	12000	400	120-277	70	Type 3	White			
7644	LED-FXSAL29/40K/DB/5S	4000K	29	3190	100-150	120-277	70	Type 5	Dark Bronze			
7645	LED-FXSAL29/50K/DB/5S	5000K	29	3190	100-150	120-277	70	Type 5	Dark Bronze			
7646	LED-FXSAL29/40K/WH/5S	4000K	29	3190	100-150	120-277	70	Type 5	White			
7647	LED-FXSAL29/50K/WH/5S	5000K	29	3190	100-150	120-277	70	Type 5	White			
7648	LED-FXSAL50/40K/DB/5S	4000K	50	5750	250	120-277	70	Type 5	Dark Bronze			
7649	LED-FXSAL50/50K/DB/5S	5000K	50	5750	250	120-277	70	Type 5	Dark Bronze			
7650	LED-FXSAL50/40K/WH/5S	4000K	50	5750	250	120-277	70	Type 5	White			
7651	LED-FXSAL50/50K/WH/5S	5000K	50	5750	250	120-277	70	Type 5	White			
7652	LED-FXSAL75/40K/DB/5S	4000K	75	8625	250-400	120-277	70	Type 5	Dark Bronze			
7653	LED-FXSAL75/50K/DB/5S	5000K	75	8625	250-400	120-277	70	Type 5	Dark Bronze			
7654	LED-FXSAL75/40K/WH/5S	4000K	75	8625	250-400	120-277	70	Type 5	White			
7655	LED-FXSAL75/50K/WH/5S	5000K	75	8625	250-400	120-277	70	Type 5	White			
7656	LED-FXSAL100/40K/DB/5S	4000K	100	12000	400	120-277	70	Type 5	Dark Bronze			
7657	LED-FXSAL100/50K/DB/5S	5000K	100	12000	400	120-277	70	Type 5	Dark Bronze			
7658	LED-FXSAL100/40K/WH/5S	4000K	100	12000	400	120-277	70	Type 5	White			
7659	LED-FXSAL100/50K/WH/5S	5000K	100	12000	400	120-277	70	Type 5	White			
180W - 360W												
7632	LED-FXSAL180/40K/DB/3S	4000K	180	21600	400-575	120-277	70	Type 3	Dark Bronze			
7633	LED-FXSAL180/50K/DB/3S	5000K	180	21600	400-575	120-277	70	Type 3	Dark Bronze			
7634	LED-FXSAL180/40K/WH/3S	4000K	180	21600	400-575	120-277	70	Type 3	White			
7635	LED-FXSAL180/50K/WH/3S	5000K	180	21600	400-575	120-277	70	Type 3	White			
7636	LED-FXSAL240/40K/DB/3S	4000K	240	28800	750-1000	120-277	70	Type 3	Dark Bronze			
7637	LED-FXSAL240/50K/DB/3S	5000K	240	28800	750-1000	120-277	70	Type 3	Dark Bronze			
7638	LED-FXSAL240/40K/WH/3S	4000K	240	28800	750-1000	120-277	70	Type 3	White			
7639	LED-FXSAL240/50K/WH/3S	5000K	240	28800	750-1000	120-277	70	Type 3	White			
7640	LED-FXSAL360/40K/DB/3S	4000K	360	43200	1000-1250	120-277	70	Type 3	Dark Bronze			
7641	LED-FXSAL360/50K/DB/3S	5000K	360	43200	1000-1250	120-277	70	Type 3	Dark Bronze			
7642	LED-FXSAL360/40K/WH/3S	4000K	360	43200	1000-1250	120-277	70	Type 3	White			
7643	LED-FXSAL360/50K/WH/3S	5000K	360	43200	1000-1250	120-277	70	Type 3	White			
7660	LED-FXSAL180/40K/DB/5S	4000K	180	21600	400-575	120-277	70	Type 5	Dark Bronze			
7661	LED-FXSAL180/50K/DB/5S	5000K	180	21600	400-575	120-277	70	Type 5	Dark Bronze			
7662	LED-FXSAL180/40K/WH/5S	4000K	180	21600	400-575	120-277	70	Type 5	White			
7663	LED-FXSAL180/50K/WH/5S	5000K	180	21600	400-575	120-277	70	Type 5	White			

Item Code	Description	Color Temp	Wattage	Lumen Output	Equivalent Wattage	Voltage (V)	CRI	Beam Angle	Color			
7664	LED-FXSAL240/40K/DB/5S	4000K	240	28800	750-1000	120-277	70	Type 5	Dark Bronze			
7665	LED-FXSAL240/50K/DB/5S	5000K	240	28800	750-1000	120-277	70	Type 5	Dark Bronze			
7666	LED-FXSAL240/40K/WH/5S	4000K	240	28800	750-1000	120-277	70	Type 5	White			
7667	LED-FXSAL240/50K/WH/5S	5000K	240	28800	750-1000	120-277	70	Type 5	White			
7668	LED-FXSAL360/40K/DB/5S	4000K	360	43200	1000-1250	120-277	70	Type 5	Dark Bronze			
7691	LED-FXSAL360/50K/DB/5S	5000K	360	43200	1000-1250	120-277	70	Type 5	Dark Bronze			
7670	LED-FXSAL360/40K/WH/5S	4000K	360	43200	1000-1250	120-277	70	Type 5	White			
7671	LED-FXSAL360/50K/WH/5S	5000K	360	43200	1000-1250	120-277	70	Type 5	White			

Mounting

P10101	MT-SAL/SF/DB	Slip Fitter
P10103	MT-SAL/SB/DB	Swivel Bracket
P10105	MT-SAL/EA6/DB	6" Extended Arm Dark
TBD	TBD	Yoke Mount

► Dimensions

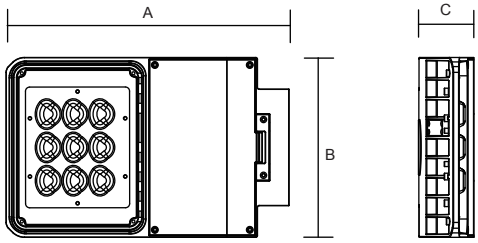
	Wattage	A	B	C	Weight
	29 50 75 100	13.38-in	8.66-in	2.56-in	- lbs
Coming soon	Wattage	A	B	C	Weight
	180 240 360				

► Master Carton Package

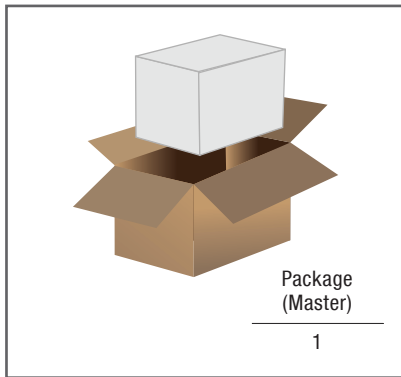

Appendix B
Institute of Lighting Professionals Guidance
Note for the Reduction of Obtrusive Light

Guidance Note 01/20

Guidance note for the reduction of obtrusive light



Copyright © 2020 ILP

All rights reserved. No part of this publication may be reproduced, stored in a retrieval system or transmitted in any form or by any means: electronic, electrostatic, magnetic tape, mechanical, photocopying, recording or otherwise, without permission in writing from the Institution of Lighting Professionals.

The copyright of the data detailed within this guide belongs to CIE, email ciecb@cie.co.at
This document should be used in conjunction with CIE 150:2017 and CIE 126:1997 and not as a replacement for the procedures contained therein.

These documents can be obtained from <https://www.techstreet.com/cie/pages/home> and members of a National Committee of the CIE can purchase them with a discount of 66.7%.

Institution of Lighting Professionals
Regent House
Regent Place
Rugby
Warwickshire
CV21 2PN

Tel: (01788) 576492
Email: info@theilp.org.uk

Website: www.theilp.org.uk

Registered Charity Number 268547

This guidance note has been revised to reflect the changes in international guidance regarding obtrusive light as detailed in CIE 150:2017 *Guide on the limitation of the effects of obtrusive light from outdoor lighting installations*.¹ It also considers industry comment regarding the assessment and definition of obtrusive lighting.

Good lighting practice is the provision of the right light, at the right time, in the right place, controlled by the right system.

Humanity's invention of artificial light and its application in the external environment has done much to safeguard and enhance our night-time environment but, if not properly controlled, *obtrusive light* (sometimes referred to as light pollution) can present serious physiological and ecological problems.

Obtrusive light – whether it keeps you awake through a bedroom window, impedes your view of the night sky or adversely affects the performance of an adjacent lighting installation – is a form of pollution, which may also be a nuisance in law and which can be substantially mitigated without detriment to the lighting requirements of the task.

Sky glow, the brightening of the night sky, *glare* the uncomfortable brightness of a light source when viewed against a darker background, *light spill* the spilling of light beyond the boundary of the area being lit and *light intrusion* (“nuisance”)² are all forms of obtrusive light which may cause nuisance to others, or adversely affect fauna and flora as well as waste money and energy.

Considerations to be made

Think before you light. Is it necessary? What effect could it have on others? Has it the potential to cause a nuisance? How can you mitigate and manage any potential adverse effects from your lighting installation?

There are published standards and guidance for most lighting tasks, adherence to which will help mitigate obtrusive lighting aspects. Organisations from which full details of these standards can be obtained are given later in this Guidance Note.

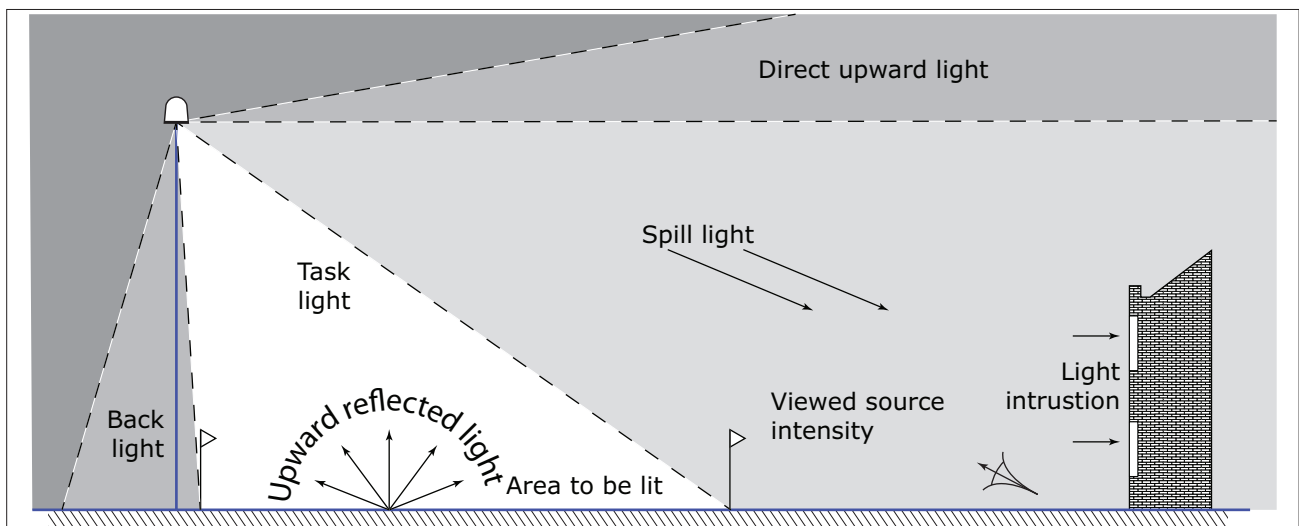

Figure 1: Types of intrusive light

1 The copyright of the data detailed within this guide belongs to CIE, email ciecb@cie.co.at. This document should be used in conjunction with CIE 150:2017 and CIE 126:1997 and not as a replacement for the procedures contained therein. These documents can be obtained from <https://www.techstreet.com/cie/pages/home> and members of a National Committee of the CIE can purchase them with a discount of 66.7%.

2 The term light trespass is sometimes used, but trespass is to physically encroach on land and light can't do that, so the term nuisance should always be used.

For the purpose of this Guidance Note the following two Commission Internationale De L'Éclairage (CIE) documents are specifically referenced; they provide guidance to the mitigation of obtrusive light from exterior lighting installations:

- CIE 150:2017 Guide on the limitation of the effects of obtrusive light from outdoor lighting installations;
- CIE 126-1997 Guidelines for minimizing sky glow

When considering any lighting installation these two documents should be referenced.

Whilst this Guidance Note specifically considers the effects from external lighting installations, the considerations within it can be relevant when considering modern office blocks and shop fronts where the main external facing structure is transparent and light from within the buildings could become a source of illumination to the exterior environment.

"Good Design Equals Good Lighting"

It cannot be stressed sufficiently that employing a competent lighting designer with proven experience in the lighting application being considered will provide a suitable lighting installation where all obtrusive lighting aspects are mitigated³.

Any lighting scheme consists of three basic elements: a light source, a luminaire (incorporating the optical control system) and a method of installation/mounting.

Light sources (lamps/LEDs)

Remember that the light source output in lumens is not the same as the wattage and that it is the former that is important in combating the problems of obtrusive light.

Most night-time visual tasks are only dependent on light radiated within the visual spectrum. It is therefore not necessary for light sources to emit either ultra-violet or infra-red radiation unless specifically required to do so. The majority of light sources used in external lighting do not contain these wavelengths or where they are present their spectral power is very low.

Research indicates that light from the blue end of the spectrum could have important adverse effects on fauna and flora. The lighting designer should consider the blue light spectral power of the light source and try to balance the needs of the task to be lit with any impact on fauna and flora within the environment.

Luminaires

The choice of luminaire with the right optical distribution at the right mounting height is critical to minimising light spill and obtrusive light effects while providing the right lighting performance on the task area.

Sky glow is the general diffuse sheen that is visible in the direction of large cities, airports, and industrial complexes. It occurs from both natural and artificial light sources and does not depend exclusively on the lighting design. It also depends on the atmospheric conditions (humidity, aerosols, clouds, haze, atmospheric pollution, etc). Light propagating into the atmosphere either directly from upward directed or incompletely shielded sources, or after reflection from the ground or other surfaces, is partially scattered back towards observers on the ground; the impact being shown in Table 1.

It is therefore important to consider the luminaire, its light distribution, how it is installed, and how it is set up.

For most general sports and area lighting installations the use of luminaires with asymmetric optics designed so that the front glazing is kept at or near parallel to

³ Competency can be determined through membership of a professional lighting body supported by the appropriate qualifications and experience in the application of lighting required.

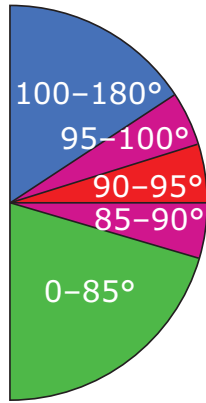

Indicative diagram

Table 1: The effect on the ability to view the night sky at various angles		
Angle of light emitted (degrees)	Sky glow effect	Glare effect
100 – 180	Local	Little
95 – 100	Significant	Some
90 – 95	High	High
85 – 90	Significant	High
0 – 85	Minimal	Some

the surface being lit should, if correctly aimed, ensure minimum obtrusive light.

Appendices 1 and 2 in this Guidance Note give more details of how to choose luminaires, and if necessary modify them through the use of louvres and shields.

Installation

In most cases it will be beneficial to use as high a mounting height as possible, giving due regard to the daytime appearance of the installation.

It should be noted that a lower mounting height is perhaps not better as can be seen from Figures 2a and 2b from CIE 150. A lower mounting height can create a higher level of light spill and require additional lighting points.

Keep glare to a minimum by ensuring that the main beam angle of all luminaires directed towards any potential observer is no greater than 70°. Higher mounting

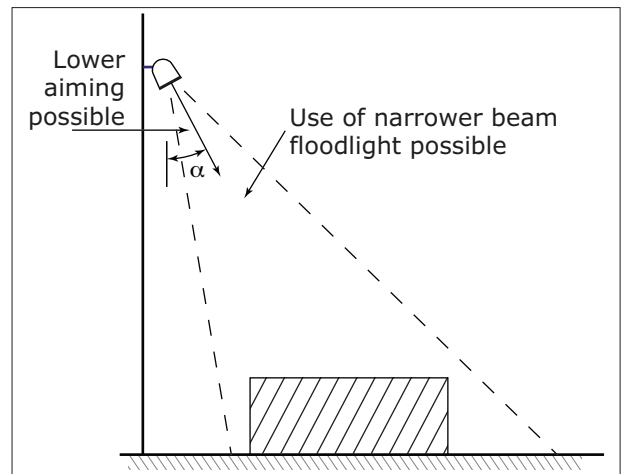

Figure 2a: Higher mounting height – less spill light and glare

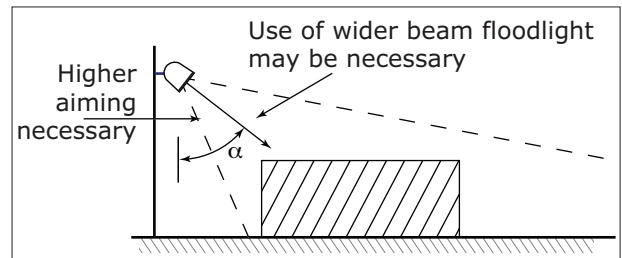

Figure 2b: Lower mounting height – more spill light and glare

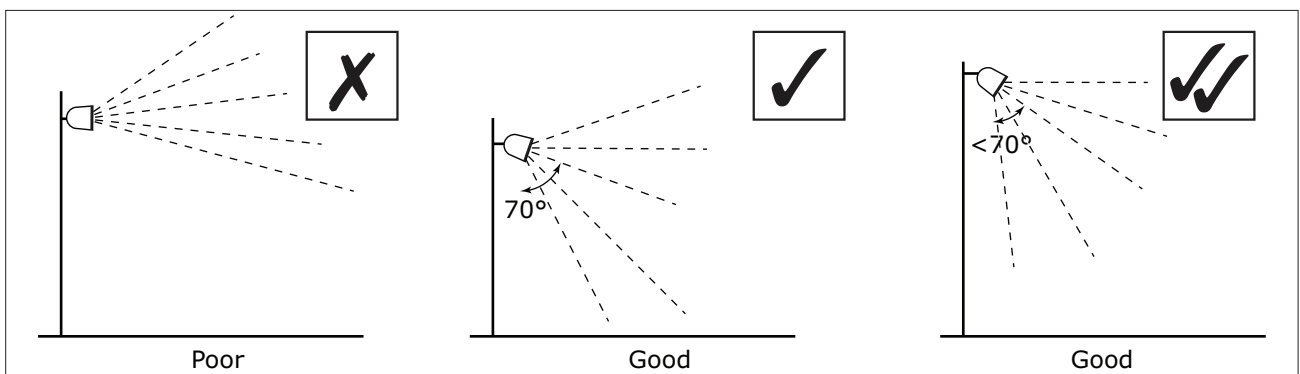

Figure 3 Luminaire aiming angles

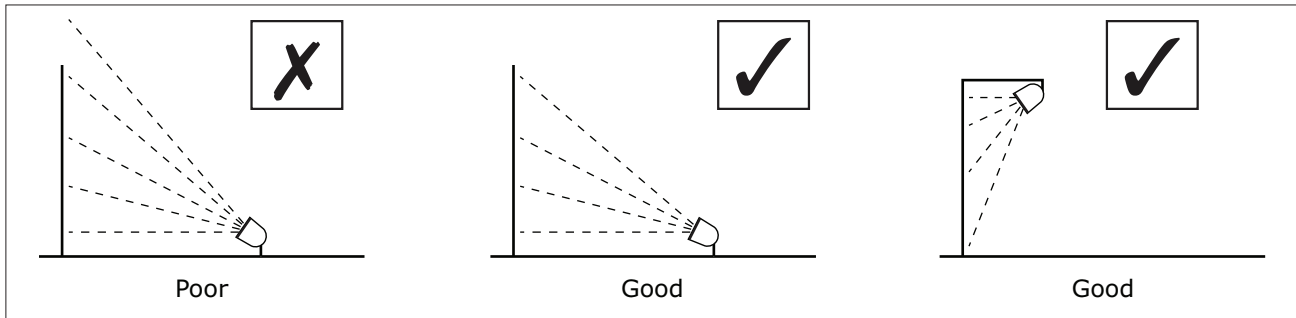

Figure 4 Façade illumination

heights allow lower main beam angles, which can assist in reducing glare.

In areas with low ambient light levels, glare can be very obtrusive, and extra care should be taken when positioning and aiming lighting equipment. With regard to domestic security lighting, the ILP produces an information leaflet GN09:2018 *Domestic exterior lighting: getting it right!* which is freely available from its website.

When lighting vertical structures such as advertising signs, direct light downwards wherever possible. If there is no alternative to up-lighting, as with much decorative lighting of buildings, then the use of luminaires with the correct optical distribution, coupled where required with shields, baffles and louvres, will help minimise spill light around and over the structure.

For road and amenity lighting installations, light near to and above the horizontal should normally be minimised to reduce glare and sky glow (Note the Upward Lighting Ratios (ULR's) advised in Tables 5 and 6). In rural areas the use of full horizontal cut off luminaires installed at 0° uplift will, in addition to reducing sky glow, help to minimise visual intrusion within the open landscape. However, in some urban locations, luminaires fitted with a more decorative bowl and good optical control of light should be acceptable and may be more appropriate.

Clean Neighbourhoods and Environment Act 2005 (CNEA)

The Clean Neighbourhoods and Environment Act 2005 (CNEA) gives local authorities and the Environment Agency additional powers to deal with a wide range of issues by classifying artificial light emitted from defined premises as a statutory nuisance.

The CNEA 2005 amended paragraph 79(1)(fb) of the Environmental Protection Act 1990 to extend the statutory nuisance regime to include light nuisance stating the following:

'artificial light emitted from premises so as to be prejudicial to health or a nuisance'.

Guidance produced on Sections 101 to 103 of the CNEA 2005 by DEFRA (DEFRA, April 2006) extends the duty on local authorities to ensure their areas are checked periodically for existing and potential sources of statutory nuisances including nuisances arising from artificial lighting. Local authorities must take reasonable steps to investigate complaints of such nuisances from artificial light. Once satisfied that a statutory nuisance exists or may occur or recur, local authorities must issue an abatement notice (in accordance with section 80(2) of the Environmental Protection Act 1990), requiring that the nuisance cease or be abated within a set timescale.

National Planning Policy Framework (NPPF)

The NPPF was introduced as a more concise and useable planning document to aid developers and designers in the design and construction of developments within the UK.

The National Planning Policy Framework 2019 makes little reference to lighting with regard to the control of obtrusive light with section being the only reference, which states:

c) limit the impact of light pollution from artificial light on local amenity, intrinsically dark landscapes and nature conservation.

With regard to the planning aspect, many local planning authorities (LPAs) have already produced, or are producing, policies that within the planning system will become part of their local development framework. For new developments there is an opportunity for LPAs to impose planning conditions related to external lighting, including curfew hours.

National planning policy

The national on-line planning guidance resource looks at when lighting pollution concerns should be considered.

The guidance provides a high-level overview for planners, with links to appropriate documents looking at the subject through seven discussion points:

- What light pollution considerations does planning need to address?
- What factors can be considered when assessing whether a development proposal might have implications for light pollution?
- What factors are relevant when considering where light shines?
- What factors are relevant when considering when light shines?
- What factors are relevant when considering how much the light shines?

- What factors are relevant when considering possible ecological impacts of lighting?
- What other information is available that could inform approaches to lighting and help reduce light pollution?

It is to be hoped that whilst the guide does not specifically require it planners will consider the application of artificial light and consult with lighting designers. The planners can then be advised on the planning conditions that might be applicable for each project and review any submissions to determine if the planning conditions have been met.

The Scottish Executive has published a design methodology document (March 2007) entitled “*Controlling Light Pollution and Reducing Lighting Energy Consumption*” to further assist in mitigating obtrusive light elements at the design stage.

Environmental zones

It is recommended that local planning authorities specify the environmental zones given in Table 2 for exterior lighting control within their development plans.

Design guidance

The following limitations based upon CIE150 may be supplemented or replaced by an LPA’s own planning guidance for exterior lighting installations. As lighting design is not as simple as it may seem, you are advised to consult and/or work with a competent professional lighting designer when considering any exterior lighting.

Table 2: Environmental zones

Zone	Surrounding	Lighting environment	Examples
E0	Protected	Dark (SQM 20.5+)	Astronomical Observable dark skies, UNESCO starlight reserves, IDA dark sky places
E1	Natural	Dark (SQM 20 to 20.5)	Relatively uninhabited rural areas, National Parks, Areas of Outstanding Natural Beauty, IDA buffer zones etc.
E2	Rural	Low district brightness (SQM ~15 to 20)	Sparsely inhabited rural areas, village or relatively dark outer suburban locations
E3	Suburban	Medium district brightness	Well inhabited rural and urban settlements, small town centres of suburban locations
E4	Urban	High district brightness	Town/city centres with high levels of night-time activity

Notes:

1. Where an area to be lit lies on the boundary of two zones the obtrusive light limitation values used should be those applicable to the most rigorous zone.
2. Rural zones under protected designations should use a higher standard of policy.
3. Zone E0 must always be surrounded by an E1 Zone.
4. Zoning should be agreed with the local planning authority and due to local requirements a more stringent zone classification may be applied to protect special/specific areas.
5. SQM (Sky Quality Measurements) referenced by the International Dark-Sky Association (IDA), the criteria for E0 being revised in mid 2019 but not retrospective.
6. Astronomical observable dark skies will offer clearer views of the Milky Way and of other objects such as the Andromeda galaxy and the Orion Nebula.
7. Although values of SQM 20 to 20.5 may not offer clear views of astronomical dark sky objects such as the Milky Way, these skies will have their own relative intrinsic value in the UK.

Table 3 (CIE 150 table 2): Maximum values of vertical illuminance on properties.

Light technical parameter	Application conditions	Environmental zone				
		E0	E1	E2	E3	E4
Illuminance in the vertical plane (E_v)	Pre-curfew	n/a	2 lx	5 lx	10 lx	25 lx
	Post-curfew	n/a	<0.1 lx*	1 lx	2 lx	5 lx

Note:

- * If the installation is for public (road) lighting then this may be up to 1 lx.

Recommended maximum values of light parameters for the control of obtrusive light

Limitation of illumination on surrounding properties

Light intrusion/nuisance

Limits apply to nearby dwellings/premises or potential dwellings/premises and specifically windows; the values are the summation of all lighting installations.

Spill light

Table 3 can also be considered for the management of spill light; however, designers must consider the task performance requirements of any adjacent lit areas and ensure that any spill light does not adversely affect these performance parameters as this could affect their safe use. This may result in a need to minimise spill and intrusive lighting values to less than might be expected for the environmental zone within which the installation lies.

Limitation of bright luminaires in the field of view.

The limits for the luminous intensity of bright luminaires are dependent on the viewing distance d , (between the observer and the bright luminaire(s)) and the projected area A_p , of the bright part of the luminaire in the direction of the observer.

Table 4 shows the maximum values for the luminous intensity of luminaires in designated directions where views of bright surfaces of luminaires are likely to be a nuisance to occupants of premises or from positions where such views are likely to be maintained, that is, not momentary or short-term.

Considerations to aid the application of Table 4 and the assessment process.

- a) The assessment of A_p for observers can prove difficult and will vary for all observer positions and distances. To aid this assessment values of A_p corresponding to the geometric mean diameter of each luminaire group have been extracted from CIE 150 Annex C and included within Table 4. These areas can be considered for an assessment of likely A_p in the observer direction to calculate a maximum luminous intensity value.
- b) The above information is applicable for the consideration of a single luminaire but where two or more luminaires are located in close proximity to each other that to the observer they appear as a single light source then the assessment shall be undertaken based upon the combined bright surfaces of luminaires (A_p) in the direction of the observer or, from positions where such views are likely to be maintained.
- c) In installations that involve mast lighting the luminaires will often be viewed against the night sky. The contrast between the background sky and the bright surface areas of the luminaires can be considerable. In such installations the curfew levels set for each environmental zone shall be applied with the exception that such installations within an E4 zone will be designed to suit the curfew requirements of an E3 zone.

Limitation of the effects on transport systems

Limits apply where users of road networks are subject to a reduction in the ability to see essential information. CIE 150 2017; Table 5 gives values that are for relevant positions and for viewing directions in the path of travel.

This assessment does not just apply to road lighting installations but to any installation where luminaires positioning falls under the above definition.

Limitation of sky glow

See Tables 6 and 7

Table 4 (CIE 150 table 3 (amended)): Limits for the luminous intensity of bright luminaires⁴.

Light technical parameter	Application conditions	Luminaire group (projected area A_p in m^2)					
		$0 < A_p \leq 0.002$	$0.002 < A_p \leq 0.01$	$0.01 < A_p \leq 0.03$	$0.03 < A_p \leq 0.13$	$0.13 < A_p \leq 0.50$	$A_p > 0.5$
Maximum luminous intensity emitted by luminaire (I in cd)	E0						
	Pre-curfew	0	0	0	0	0	0
	Post-curfew	0	0	0	0	0	0
	E1						
	Pre-curfew	0.29 <i>d</i>	0.63 <i>d</i>	1.3 <i>d</i>	2.5 <i>d</i>	5.1 <i>d</i>	2,500
	Post-curfew	0	0	0	0	0	0
	E2						
	Pre-curfew	0.57 <i>d</i>	1.3 <i>d</i>	2.5 <i>d</i>	5.0 <i>d</i>	10 <i>d</i>	7,500
	Post-curfew	0.29 <i>d</i>	0.63 <i>d</i>	1.3 <i>d</i>	2.5 <i>d</i>	5.1 <i>d</i>	500
	E3						
	Pre-curfew	0.86 <i>d</i>	1.9 <i>d</i>	3.8 <i>d</i>	7.5 <i>d</i>	15 <i>d</i>	10,000
	Post-curfew	0.29 <i>d</i>	0.63 <i>d</i>	1.3 <i>d</i>	2.5 <i>d</i>	5.1 <i>d</i>	1,000
	E4						
	Pre-curfew	1.4 <i>d</i>	3.1 <i>d</i>	6.3 <i>d</i>	13 <i>d</i>	26 <i>d</i>	25,000
	Post-curfew	0.29 <i>d</i>	0.63 <i>d</i>	1.3 <i>d</i>	2.5 <i>d</i>	5.1 <i>d</i>	2,500
	Aid to gauging A_p		2 to 5cm	5 to 10cm	10 to 20cm	20 to 40cm	40 to 80cm
Geometric mean of diameter (cm)		3.2	7.1	14.1	26.3	56.6	>80
Corresponding A_p representative area (m^2)		0.0008	0.004	0.016	0.063	0.251	>0.5

Notes:

1. *d* is the distance between the observer and the glare source in metres;
2. A luminous intensity of 0 cd can only be realised by a luminaire with a complete cut-off in the designated directions;
3. A_p is the apparent surface of the light source seen from the observer position
4. For further information refer to Annex C of CIE 150
5. Upper limits for each zone shall be taken as those with column $A_p > 0.5$

Limitations of the effect of over-lit building façades and signs

Table 8 provides recommendations regarding luminance values that provide visibility in order that a balanced urban lighting master plan can be considered and

such lighting does not cause negative impacts such as a continuous increase in the lighting levels (ratcheting) between buildings and within areas and light pollution.

Illuminated advertising signage should be assessed as advised in the ILP's Professional Lighting Guide *The brightness of illuminated advertisements*, (PLG 05)

⁴ Amended based upon the approach taken by NSVV Nederlandse Stichting Voor Verlichtingskunde (Dutch: Dutch Foundation for Illumination; The Netherlands) and to consider CIE 150 Annex C Table C.2

Table 5 (CIE 150 table 4): Maximum values of threshold increment and viewing direction in the path of travel.

Light technical parameter	Road classification*			
	No road lighting	M6/M5	M4/M3	M2/M1
Veiling luminance [†] (L_v)	0.037 cd/m ²	0.23 cd/m ²	0.40 cd/m ²	0.84 cd/m ²
Threshold increment	15% based on adaption luminance of 0.1 cd/m ²	15% based on adaption luminance of 1.0 cd/m ²	15% based on adaption luminance of 2.0 cd/m ²	15% based on adaption luminance of 5 cd/m ²

Notes:

* Road classifications as given in CIE 115:2010

† The veiling luminance values specified in this table are based upon on a permissible TI value of 15%

Definitions:

TI The measure of disability glare (the reduction in visibility caused by intense light sources in the field of view) expressed as the percentage increase in contrast required between an object and its background for it to be seen equally well with a source of glare present. Note: Higher values of TI correspond to greater disability glare.

L_v The luminance that would need to be superimposed on a scene in object space to reduce the scene's contrast by an amount equal to the added retinal illuminance from scattered light on the scene's retinal image. It is most commonly used to describe the contrast-reducing effect of a glare source in the field of view.

Table 6 (CIE 150 table 5): Maximum values of upward light ratio (ULR) of luminaires.

Light technical parameter	Environmental zones				
	E0	E1	E2	E3	E4
Upward light ratio (ULR)/%	0	0	2.5	5	15

Note:

This does not take into account the effect of light reflected upwards from ground that also contributes to sky glow. This is the traditional method to limit sky glow and is suitable to compare different single luminaires.

For illuminated advertising signs the aim should be to achieve the limits advised in PLG05.

Table 7 (CIE 150 table 6): Maximum values of upward flux ratio of installation (of four or more luminaires).

Light technical parameter	Type of installation	Environmental zones				
		E0	E1	E2	E3	E4
Upward flux ratio (UFR)/%	Road	n/a	2	5	8	12
	Amenity	n/a	n/a	6	12	35
	Sports	n/a	n/a	2	6	15

Notes:

Table 7 allows the effect of both direct and reflected upward components of a whole installation to be taken into account. The factor being the upward flux ratio (UFR) and CIE 150 suggests that table 7 is used for all installations consisting of four or more luminaires.

Clauses 6.4.2 and 6.4.3 of CIE 150:2017 describe the calculation methods for both ULP and UFR.

Light emitted just above the horizontal in a zone between 90° and 110° is extra critical for sky glow in large open areas around observatories. An additional measure in these areas limits the luminous intensities ($I_{90} - I_{110}$) as follows:

- between 90° and 100° < 0.5 cd/1000lm;
- between 100° and 110° 0 cd.

Table 8 (CIE 150 table 7): Maximum permitted values of average surface luminance (cd/m²).

Light technical parameter	Application conditions	Environmental zones				
		E0	E1	E2	E3	E4
Building façade luminance (L_b)	Taken as the product of the design average illuminance and reflectance divided by n	< 0.1	< 0.1	5	10	25
Sign luminance (L_s)	Taken as the product of the design average illuminance and reflectance divided by n, or for self-luminous signs, its average luminance.	< 0.1	50	400	800	1.000

Note:

The values apply to both pre- and post-curfew, except that in zones 0 and 1 the values shall be zero post curfew. The values for signs do not apply to signs for traffic control purposes.

Relevant publications and standards

British Standards

- BS 5489-1:2013 *Code of practice for the design of road lighting – Part 1 Lighting of roads and public amenity areas;*
- BS EN 13201-2:2015 *Road lighting. Part 2: Performance requirements;*
- BS EN 13201-3:2015 *Road lighting. Part 3: Calculation of performance;*
- BS EN 13201-4:2015 *Road lighting. Part 4: Methods of measuring lighting performance;*
- BS EN 12193:2018 *Light and lighting. Sports lighting;*
- BS EN 12464-2:2014 *Lighting of work places. Outdoor work places;*
- PD CEN TR 13201-1:2014 *Road lighting. Guidelines on selection of lighting classes.*

CIE publications

- CIE 001 *Guidelines for minimizing urban sky glow near astronomical observatories;*
- CIE 094-1993 *Guide for floodlighting;*
- CIE 112-1994 *Glare evaluation system for use within outdoor sport and area lighting;*
- CIE 115:2010 *Lighting of roads for motor and pedestrian traffic;*
- CIE 126:1997 *Guidelines for minimizing sky glow;*
- CIE 129:1998 *Guide for lighting exterior work areas;*
- CIE 136:2000 *Guide to the lighting of urban areas;*
- CIE 150:2017 *Guide on the limitation of the effects of obtrusive light from outdoor lighting installations;*
- CIE 169:2005 *Practical design guidelines for the lighting of sport events for colour.*

ILP publications

- PLG04 *Guidance on undertaking environmental lighting impact assessments;*

- PLG05 *The brightness of illuminated advertisements;*
- PLG06 *Guidance on installation and maintenance of seasonal decorations and lighting column attachments*
- GN09 *Domestic exterior lighting: getting it right!*

SLL/CIBSE Publications

- LG01 *The industrial environment* (2018);
- LG04 *Sports lighting;*
- LG06/16 *The exterior environment;*
- LGL0L *Guide to limiting obtrusive light.*

NB: These notes are intended as guidance only and the application of the values given in the various tables should be given due consideration along with all other factors in the lighting design. Lighting is a complex subject with both objective and subjective criteria to be considered. The notes are therefore no substitute for professionally assessed and designed lighting, where the various and maybe conflicting visual requirements need to be balanced.

Acknowledgements

Allan Howard – WSP (Chair)

Peter Raynham – UCL

Dan Oakley – South Downs National Park

Appendix 2 images – acdc

Appendix 1

Outdoor luminaire classification system

Based upon CIE 150:2017 and for the purpose of this and associated documents the following figures illustrate the luminaire classification (CIE 150:2017)

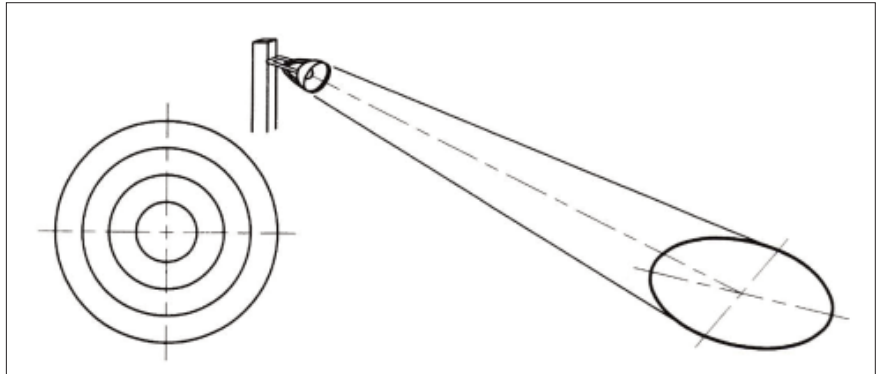
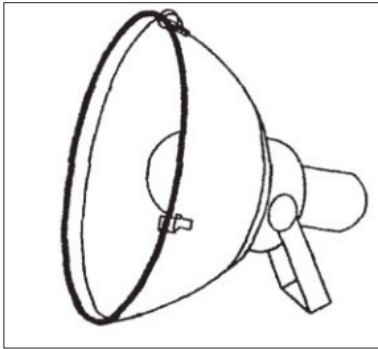

Type A: Floodlight/projector producing a symmetrical beam

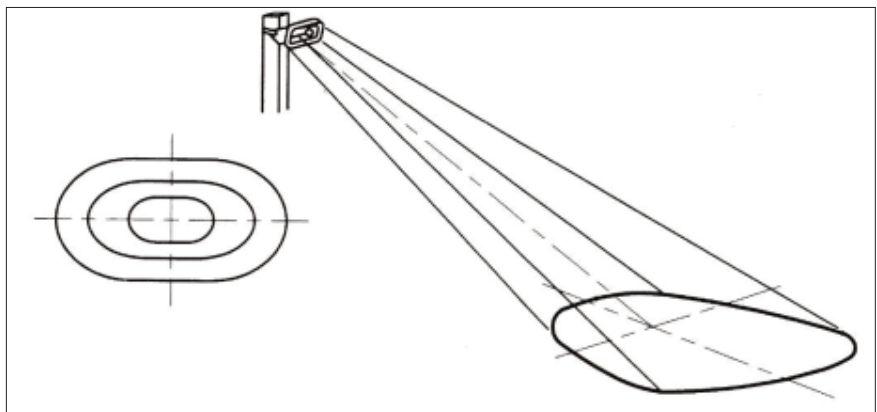
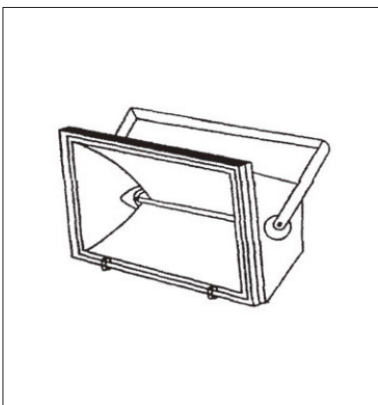

Type B: Floodlight/projector producing a fan-shaped beam

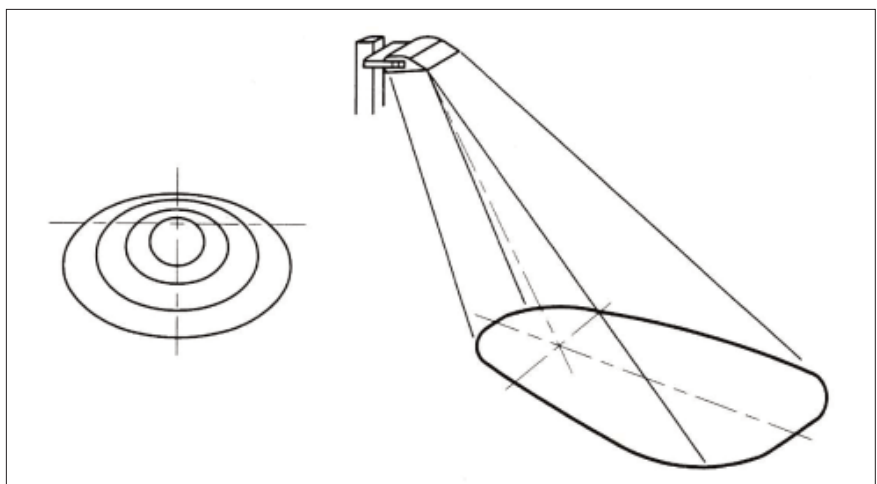
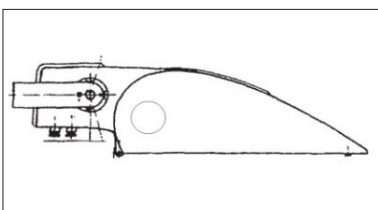

Type C: Floodlight/projector producing a double asymmetric distribution in the vertical plane

Appendix 2

Illustrations of luminaire accessories for limiting obtrusive light



Luminaire with cowl, hood and shield



With louvre



With cowl



about GHD

GHD is one of the world's leading professional services companies operating in the global markets of water, energy and resources, environment, property and buildings, and transportation. We provide engineering, environmental, and construction services to private and public sector clients.

Gordon Reusing
Gordon.Reusing@ghd.com
519.340.4231

www.ghd.com