

**APPENDIX I
HYDROLOGY AND CLIMATE TECHNICAL SUPPORT DOCUMENT**



ADDENDUM – HYDROLOGY

RESPONSE LETTER TO COMMENTS ON THE IAMGOLD CÔTÉ GOLD PROJECT ENVIRONMENTAL IMPACT STATEMENT (EIS)/DRAFT ENVIRONMENTAL ASSESSMENT (EA) REPORT TECHNICAL SUPPORT DOCUMENT: HYDROLOGY

1.0 INTRODUCTION

This addendum to Appendix I - Hydrology Technical Support Document (TSD) has been prepared to address comments received from the Aboriginal groups, government reviewers and interested stakeholders on the Environmental Impact Statement (EIS)/Draft Environmental Assessment (EA) Report.

Comments submitted to IAMGOLD have been provided and responded to in Appendix Z of the Amended EIS/Final EA Report. Minor editorial comments related to the TSD have been directly addressed through updates in the TSD, and these changes are tracked in Appendix Z. Comments that request additional information to support the TSD have been addressed through this addendum to the Hydrology TSD and generally focused on the following technical areas:

- data collection uncertainty;
- Mesomikenda Lake freshwater removals; and
- Bagsverd Creek.

2.0 DATA COLLECTION UNCERTAINTY

This section provides responses to Comments #479 and 481, which were related to uncertainty in the hydrological rating curves developed at the site, and the flow contribution from each of the studied watersheds. Data collected during the period 2012 and 2013 as described in the Hydrology TSD noted transient changes to rating curves at some locations, primarily due to the construction of beaver dams and changes to road crossings and culverts. Where possible, these transient changes were addressed by shifting rating curves or by incorporating survey data, presented in Appendix I. Monitoring of the previously described hydrological stations has continued into 2014 and is ongoing.

During the development of the hydrological model, the simulated output based on the applied rating curves was compared to the relative contributing area in each of the major studied watersheds (i.e., the Mesomikenda Lake and Mollie River watersheds). As detailed in Table 1a, the relative simulated average annual discharge at the monitored and simulated flow locations were within 4% of the relative watershed contributing areas. In this respect, the applied rating curves were considered acceptable. As noted, hydrological monitoring is ongoing at the Project Site.



Table 1a: Watershed Area and Average Annual Discharge

Location	Watershed	Watershed Area (ha)	Simulated Average Annual Discharge (m ³ /d)	Area % of Total Watershed	Discharge % of Total Discharge	Difference
Mesomikenda Lake Outflow	Mesomikenda	63,700	498,600	100%	100%	0%
Neville Lake Outflow	Mesomikenda	30,000	234,400	47%	47%	0%
Somme River Outflow	Mesomikenda	20,000	155,300	31%	31%	0%
Effluent Discharge at Bagsverd Creek	Mesomikenda	8,400	69,500	13%	14%	1%
Bagsverd Creek Upstream of Effluent Discharge	Mesomikenda	8,200	68,200	13%	14%	1%
Un-named Lake 2 Outflow	Mesomikenda	1,300	10,000	2%	2%	0%
Bagsverd Lake Outflow	Mesomikenda	4,300	34,000	7%	7%	0%
Schist Lake Outflow	Mesomikenda	3,100	24,700	5%	5%	0%
Little Clam Lake Outflow	Mesomikenda	30	200	<1%	<1%	0%
West Beaver Pond Outflow	Mesomikenda	380	1,900	<1%	<1%	0%
Dividing Lake Outflow	Mollie River	9,200	79,700	100%	100%	0%
Delaney Lake Outflow	Mollie River	900	7,500	10%	9%	1%
Three Duck Lakes Outflow	Mollie River	5,700	50,100	62%	63%	1%
Weeduck Outflow	Mollie River	100	800	1%	1%	0%
Côté Lake Outflow	Mollie River	4,300	39,000	46%	49%	3%
Clam Lake Outflow	Mollie River	400	3,100	4%	4%	0%
Chester Lake Outflow	Mollie River	3,300	31,500	36%	40%	4%

Note:

ha - hectare

m³/d – cubic metre per day

% - percent

watershed area includes upstream area (e.g. the Côté Lake contributing area includes the upstream Clam Lake and Chester Lake contributing areas).

3.0 MESOMIKENDA LAKE – FRESHWATER REMOVALS

This section provides responses to Comments #183, 473, 474 and 687 which were related to seasonal change in flow and the capacity of Mesomikenda Lake to provide freshwater to the Project under various climate conditions and withdrawal scenarios. The ability of Mesomikenda Lake to provide this process water and/or additional water demand under dry conditions will be further investigated during the Permit To Take Water application; however, we have completed additional screening calculations to assess seasonal variability and dry conditions; the results of this analysis follows.

3.1 Seasonal Conditions

The simulated seasonal variability in discharge and water level Mesomikenda Lake is summarized in Table 2a. Seasons with low discharge (summer) coincide with higher operating water level in Mesomikenda Lake and seasons with greater discharge (winter) occur during lake drawdown to allow for the capture of the spring freshet. Simulated seasonal Bagsverd Creek and Neville Lake discharges are provided for:

- 1:25-year wet, 1:25-year dry and average climate conditions; and
- Existing Conditions and Operations Phase.

Table 2a: Simulated Seasonal Discharge

Location	Watershed	Season	Seasonal Discharge (m ³ /d), Existing Conditions			Seasonal Discharge (m ³ /d), Operations Phase		
			Wet Climate Conditions	Average Climate	Dry Climate Conditions	Wet Climate Conditions	Average Climate	Dry Climate Conditions
			1:25 year		1:25 year	1:25 year		1:25 year
Bagsverd Creek upstream of Effluent Discharge	Mesomikenda	Winter	27,100	16,900	17,200	23,100	13,900	14,000
		Spring	214,100	215,500	130,600	170,600	169,800	103,600
		Summer	12,200	10,100	5,300	9,900	7,600	3,000
		Fall	86,900	30,100	44,800	71,000	26,600	36,300
Effluent Discharge at Bagsverd Creek	Mesomikenda	Winter	27,300	17,100	18,200	23,400	14,100	15,000
		Spring	218,700	219,900	132,900	181,700	176,000	105,900
		Summer	12,400	10,200	5,300	23,200	17,500	3,000
		Fall	88,800	30,900	46,200	77,800	29,200	37,700
Neville Lake Outflow	Mesomikenda	Winter	77,600	64,100	65,400	73,000	61,000	61,900
		Spring	713,200	700,300	430,100	672,700	652,300	401,100
		Summer	93,500	85,600	41,800	104,500	93,700	39,500
		Fall	289,700	87,700	104,100	277,500	85,200	94,300
Mesomikenda Lake Outflow	Mesomikenda	Winter	279,200	306,300	277,100	276,100	304,000	274,900
		Spring	725,900	590,900	549,500	691,500	558,200	531,800
		Summer	198,900	206,100	0	195,900	195,200	0
		Fall	1,252,200	891,000	614,300	1,246,100	889,600	593,700

Notes:
m³/d – cubic metre per day
zero discharge simulated when lake elevation falls below stop log setting. No seepage or low flow bypass simulated.

3.2 Mesomikenda Lake – Extended Dry Periods

To test the resiliency of Mesomikenda Lake during sustained dry periods, the 1:25-year dry climate condition was assessed as a scenario that could lead to low water levels in the studied watersheds. As summarized in Appendix I (Hydrology TSD), the 1:25-year dry year was characterized by an annual precipitation of 734 mm and an annual evaporation rate of 646 mm, resulting in an annual water surplus of 88 mm.

This climate condition was repeated for a period of ten years to represent a prolonged dry period. The model was run for this ten year period under existing conditions and under operational conditions with lake withdrawals simulated at a typical rate of 840 m³/d and a conservative scenario where process water demand and other removals totalled 55,840 m³/d (i.e., the full mill demand plus an allowance for other removals). Average annual discharge and water level for each of the ten years are displayed in Table 3a. The results suggest that there is will be no temporal trend in declining water level and/or discharge at the lake outlet and that the lake is maintained within the typical operating range.

Table 3a: Average Water Level and Discharge, Mesomikenda Lake, Ten year Dry Period

Dry Year	Existing Conditions		Operations Phase with Typical Removal rate (840 m ³ /d)		Operations Phase with Conservative Removal rate (55,840 m ³ /d)	
	Annual Average Water Level (masl)	Annual Average Discharge (m ³ /d)	Annual Average Water Level (masl)	Annual Average Discharge (m ³ /d)	Annual Average Water Level (masl)	Annual Average Discharge (m ³ /d)
1	363.5	370,000	363.5	350,000	363.4	300,000
2	363.5	370,000	363.5	360,000	363.4	300,000
3	363.5	370,000	363.5	360,000	363.4	300,000
4	363.5	370,000	363.5	360,000	363.4	300,000
5	363.5	370,000	363.5	360,000	363.4	300,000
6	363.5	370,000	363.5	360,000	363.4	300,000
7	363.5	370,000	363.5	360,000	363.4	300,000
8	363.5	370,000	363.5	360,000	363.4	300,000
9	363.5	370,000	363.5	360,000	363.4	300,000
10	363.5	370,000	363.5	360,000	363.4	300,000

Note:
m³/d – cubic metre per day
masl – metres at sea level

3.3 Mesomikenda Lake – Sensitivity to Increased Freshwater Removal Rates

To test the resiliency of Mesomikenda Lake to changes in water demand at the Project Site, additional scenarios were completed that based water removals on the following:

- an additional process water removal rate of 11,000 m³/d, representing approximately 20% of the total ore processing plant demand plus an estimated allowance for other water demand, taken as the typical rate of 840 m³/d; and
- an additional process water removal rate of 55,000 m³/d, representing the full ore processing plant demand plus an estimated allowance for other water demand, taken as the typical rate of 840 m³/d.

These additional removal rates were applied to the three climate scenarios (1:25-year dry, average and 1:25-year wet) and assumed no change to the operating plan at the outlet dam. Seasonal change in discharge and water level are summarized in Table 4a. For the largest removal case (55,840 m³/d), water level decreases were on the order of 0.1 m from the base case removal rate (840 m³/d) and discharge decreases were largest in magnitude in the dry year (Table 4a).

Table 4a: Freshwater Removal Rates at Mesomikenda Lake

Climate Condition	Season	Typical Operational Conditions (840 m ³ /d)		Additional Removal Scenario One (11,840 m ³ /d)		Additional Removal Scenario Two (55,840 m ³ /d)	
		Lake Elevation (masl)	Lake Outflow (m ³ /d)	Lake Elevation (masl)	Lake Outflow (m ³ /d)	Lake Elevation (masl)	Lake Outflow (m ³ /d)
1:25-year Dry	Winter	363.0	275,000	363.0	265,000	362.9	226,000
	Spring	363.7	532,000	363.7	524,000	363.7	493,000
	Summer	363.7	0	363.6	0	363.5	0
	Fall	363.5	594,000	363.5	570,000	363.4	479,000
Average	Winter	363.0	304,000	363.0	294,000	362.9	256,000
	Spring	364.1	558,000	364.1	546,000	364.1	500,000
	Summer	364.9	195,000	364.9	185,000	364.8	147,000
	Fall	364.0	890,000	364.0	877,000	363.9	825,000
1:25-year Wet	Winter	363.0	276,000	363.0	266,000	362.9	226,000
	Spring	364.3	691,000	364.3	680,000	364.2	632,000
	Summer	364.9	196,000	364.9	186,000	364.8	148,000
	Fall	364.3	1,246,000	364.3	1,233,000	364.3	1,178,000

Notes:

zero discharge simulated when lake elevation falls below stop log setting. No seepage or low flow bypass simulated.
no operational changes between climate conditions (e.g. changes to stop log settings based on water level)
assumes freshwater removal occurs each day at stated rate
m³/d – cubic metre per day
masl – metres at sea level

These results provide a range of potential water level and discharge changes to Mesomikenda Lake. At this time, it is anticipated that no more than 20% of the mill demand, plus an allowance for freshwater, fire and truck wash if required, will be withdrawn from Mesomikenda Lake. This allowance will be refined during future engineering studies, however, the total removal (20% plus allowance) will likely be approximately 12,000 m³/d, represented by Additional Removal Scenario One in Table 4a above. The actual removal rate will be determined in coordination with continuing engineering and permitting phases and will be in accordance with conditions outlined in the Permit to Take Water, when approved.

4.0 BAGSVERD CREEK

This section provides a response for Comment #476. Additional investigation of Bagsverd Creek was completed to complement aquatic habitat and fish passage studies. To address comments regarding the potential changes in discharge and water level along Bagsverd Creek we have:

- 1) Completed additional in-field surveying of Bagsverd Creek in summer 2014, including cross sections and longitudinal profiles at several locations in the channel.
- 2) Completed additional modelling to simulate potential change in water level and stream velocity at select locations.

For this analysis, we identified riffle sections (i.e., boulder dominated features of relatively higher gradient) along the east-west oriented portion of Bagsverd Creek, upstream of Neville Lake, as potential locations where water level change may influence opportunities for fish passage. There are two such riffle locations, each less than 60 m in length and one of which is of higher gradient and therefore has shallower water. This reach was selected to model for potential change in water level with respect to fish passage. The measured cross section for this stream reach is displayed in Figure 1a. Note that the irregularities in the cross section channel bed elevations are due to the boulders observed throughout the channel at this location.

HEC-River Analysis System, a hydraulic simulation program (U.S. Army Corps of Engineers 2010), was utilized to estimate the potential change in water level and velocity along a 100 m longitudinal profile at this reach (designated as BC-07) under a dry (1:25-year) summer flow condition for existing and operational conditions. Water level and stream velocity changes along this 100 m modelled reach are summarized in Table 5a.

Table 5a: Simulated Water Level and Stream Velocity, Riffle Reach

Reach ID	Modelled Reach Station (m)	Water level (m)			Velocity (m/s)		
		Existing Conditions (Summer)	Operations Phase (Summer)	Change	Existing Conditions (Summer)	Operations Phase (Summer)	Change
BC-07	100	1.36	1.31	-0.05	0.01	<0.01	<-0.01
	75	1.86	1.81	-0.05	<0.01	<0.01	0.00
	60	0.24	0.19	-0.05	0.16	0.15	-0.01
	50	0.19	0.14	-0.05	0.25	0.24	-0.01
	30	0.09	0.07	-0.02	0.79	0.67	-0.12
	20	0.13	0.10	-0.03	0.45	0.38	-0.07
	0	0.13	0.10	-0.03	0.46	0.38	-0.08

Note:
m – metre
m/s – metre per second

The majority of the channel at Bagsverd Creek is wetland dominated and characterized by mostly deep pools with low gradients and slow moving water. Measurements completed in summer 2014 showed that the channel shape within this portion of the stream is uniform, and can generally be characterized as 'U' shaped, as presented in Figure 1a.

A 100 m reach (designated as BC-02) was simulated using this profile to illustrate potential water level and stream velocity change in these more typical parts of Bagsverd Creek for the purpose of fish habitat assessment. For this, we used the same conditions as the riffle reach simulation (dry year, Existing Conditions and Operations Phase). Simulated change in stream velocity and water level is summarized in Table 6a.

Table 6a: Simulated Water Level and Stream Velocity, Typical Reach

Reach ID	Modelled Reach Station (m)	Water level (m)			Velocity (m/s)		
		Existing Conditions (Summer)	Operations Phase (Summer)	Change	Existing Conditions (Summer)	Operations Phase (Summer)	Change
BC-02	100	0.49	0.46	-0.03	0.02	0.01	-0.01
	85	0.84	0.81	-0.03	0.01	<0.01	<-0.01
	75	1.06	1.03	-0.03	0.01	<0.01	<-0.01
	60	0.19	0.16	-0.03	0.14	0.12	-0.02
	50	0.24	0.21	-0.03	0.09	0.06	-0.03
	40	0.54	0.51	-0.03	0.02	0.01	-0.01
	30	0.68	0.65	-0.03	0.01	0.01	0.00
	20	0.5	0.47	-0.03	0.02	0.01	-0.01
	10	0.89	0.86	-0.03	0.01	<0.01	<-0.01
	0	0.13	0.10	-0.03	0.31	0.30	-0.01

Note:
m – metre
m/s – metre per second

The results of this additional analysis of Bagsverd Creek were passed to the aquatics assessment team for further interpretation.

As described in the Hydrology TSD, several stream and lake outflow locations will have changes in flow of >100% as a result of channel realignments. For each of these locations, specific engineering and channel design that considers erosional processes as well as fish habitat and fish passage requirements will be completed.

5.0 EDITORIAL CHANGES

The following editorial changes have been made to the Hydrology TSD based on Comments received:

- Change to Figure 6 as per Comment #542, the figure has been edited to reflect the missing legend item.

Note that we have also edited:

- Figure 7, as the temperature time series was erroneously shortened;
- revised numbered Item 4) on Page 4 of Attachment 2, which stated a routing function or basin lag was applied (none was applied as per Section 3.2.3);
- included the appropriate reference (Golder 2013b) in Section 3.2.3; and
- corrected the Operational Phase Flow Schematic throughout.

6.0 CONCLUDING REMARKS

These additional hydrological analyses presented herein support the conclusions presented in the EIS/Draft EA; that the planned project will have a minimal influence on hydrological function within the Mesomikenda and Mollie River drainage systems. Practical engineering controls and environmental monitoring and mitigation plans will be implemented during each of the project phases.

7.0 REFERENCES

U.S. Army Corps of Engineers. 2010. HEC-RAS River Analysis System user's Manual. Version 4.1. CPD-68. Form approved OMB No. 0704-0188. Institute for Water Resources (HEC).

GOLDER ASSOCIATES LTD.

Stephen Kautman, M.Sc.
Hydrologist

Karen Besemann, P.Geol.
Associate/Hydrogeologist

SK/JP/KAB/ls

Attachment: Figure 1a

m:\active\2014\1190 sudbury\1192\1400877 iamgold ea follow-up gogama\reporting\responses to regulators\2. hydrology and climate addendum\1400877r3_15jan19_revised_iamgold_ea_addendum_hydrology.docx

IAMGOLD Corporation
Addendum to Hydrology TSD
Bagsverd Creek Cross Sections

FIGURE 1a

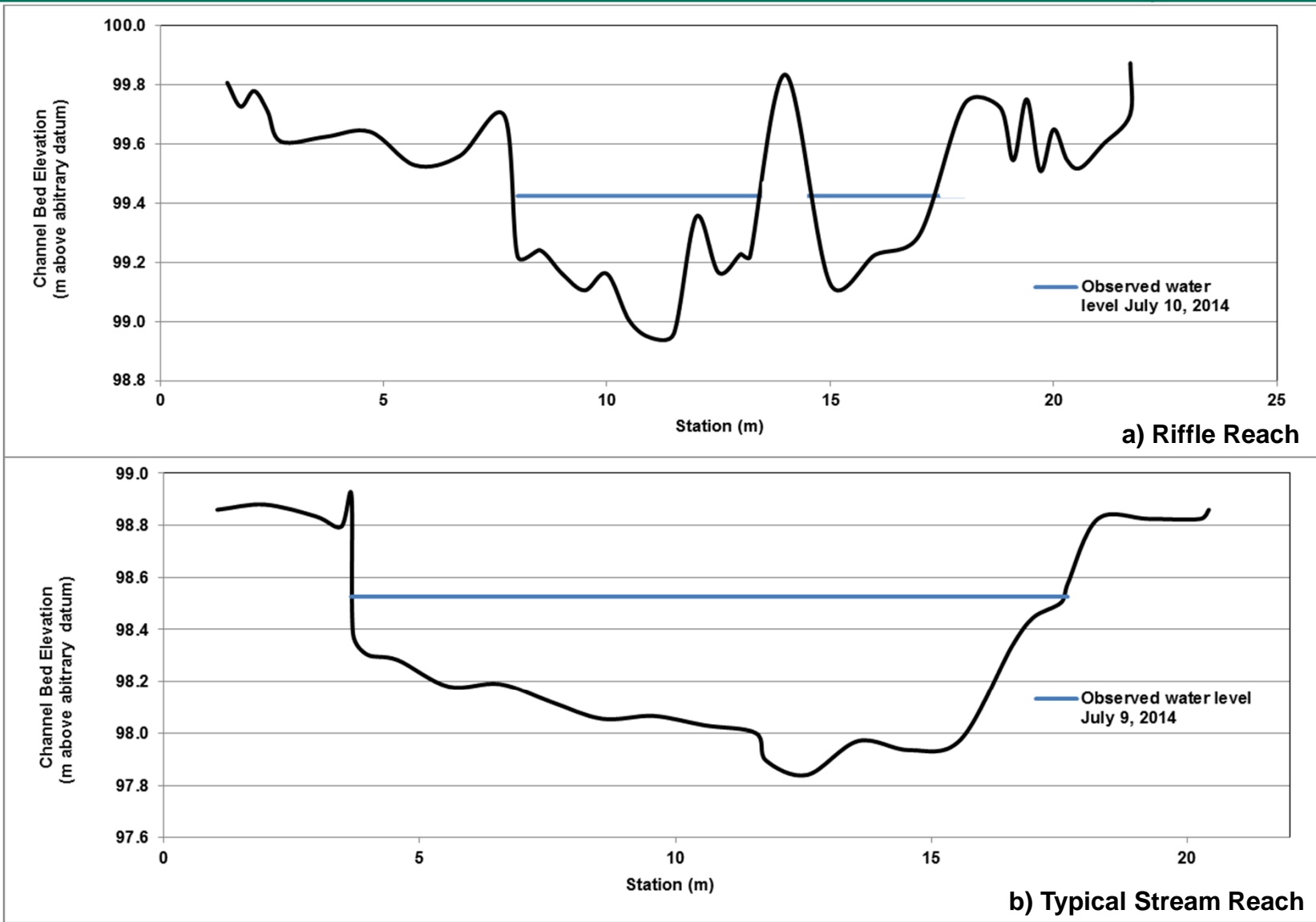



November 7, 2014

IAMGOLD CORPORATION

CÔTÉ GOLD PROJECT

ENVIRONMENTAL
ASSESSMENT REPORT

TECHNICAL SUPPORT
DOCUMENT:
HYDROLOGY

Version R2

Submitted to:
IAMGOLD Corporation
401 Bay Street, Suite 3200
Toronto, Ontario
M5H 2Y4

Uploaded via Buzzsaw

Report Number: 13-1192-0021R2

Distribution:

1 - e-copy - IAMGOLD Corporation
1 copy - Golder Associates Ltd.

REVISED REPORT





Executive Summary

IAMGOLD Corporation (IAMGOLD) intends to develop and operate an open pit gold mine and associated facilities and infrastructure in northern Ontario approximately 20 kilometres (km) southwest of Gogama, 130 km southwest of Timmins, and 200 km northwest of Sudbury; this mining project is referred to as the Côté Gold Project (the Project). The landscape is characterized with an extensive tree cover and subdued topography, and is dominated by numerous lakes, streams and wetlands along with extensive bedrock outcrops that is typical of northern Ontario. The area has experienced historical mining exploration and development, and current activities include forestry, mine exploration and some recreational activities.

The Project site will be developed through the construction of surface water realignments comprising dams and excavated channels, dewatering of Côté Lake and overburden stripping in the footprint of the open pit and the construction of a Mine Rock Area (MRA) and Tailings Management Facility (TMF). The open pit mine will be excavated to a final depth of approximately 550 m below ground and the MRA and TMF developed to their full extents during the operations phase. Active pumping of on-site water will likely be discontinued at mine closure although some pumping may continue into post-closure phases in order to facilitate flooding of the open pit and until such time as it is determined that water quality is suitable for release to the environment. These activities have the potential to affect the hydrological environment, primarily as a result of surface water realignments and changes to contributing watershed areas.

Surface water flow has been identified as an effects assessment indicator. Changes in surface water flow, as a result of Project activities could potentially affect: aquatic habitat, availability of water for human use, availability of water for hydroelectric power generation and in-stream hydrological characteristics.

A Local Study Area has been defined for the purpose of completing a prediction of the effects on surface water flow. The Local Study Area is defined by lakes and watersheds in the vicinity of, and downstream of the Project infrastructure.

A Regional Study Area was extended downstream of the project footprint, to the confluence of the Mollie River and the Makani River downstream of Mesomikenda Lake. These waterways both ultimately discharge to Minisinakwa Lake near the community of Gogama and subsequently to the Mattagami River.

Field investigations have been conducted since 2012 in order to characterize hydrological conditions. This program has included the installation of fourteen hydrological monitoring locations with automatic water level pressure dataloggers and manual staff gauges. Manual surface water flow measurements were also conducted at each location (approximately monthly) through standard velocity-area methods, using a wading rod and velocity meter. Additional bathymetric data not previously supplied was collected for several lakes.

A meteorological tower was installed on-site in May 2012 to initiate the collection of long-term climate data for the Project area. This climate station includes a datalogger connected to sensors for total precipitation, air temperature, relative humidity, wind speed, wind direction and solar radiation. The sensors and datalogger were mounted on, or are adjacent to, a 10 m aluminum tower and are downloaded approximately quarterly.

Surface water flow was broadly divided into two watersheds, defined for the purposes of the study; the Mollie River watershed which drains the southern portion of the Project site (where the MRA, open pit and processing



plant will be located), and the Mesomikenda Lake watershed which drains the northern portion of the Project Site (where the TMF and polishing pond will be located). Monitoring is ongoing, and for the period of mid-2012 to mid-2013, surface water flow at the Project Site was characterized by observed discharge conditions that ranged from less than 1 L/s in headwater lakes to greater than 8,000 L/s in monitored lakes with the largest upstream contributing watersheds.

The onsite meteorological data collected, was compared to regional climate monitoring stations and a long-term estimated climate dataset was compiled for the Project for the period 1970 to 2012. This dataset provided the basis for the generation of annual precipitation data that represented the range of conditions that may be expected over the life of the Project (i.e., average annual, 1:25-year wet conditions and 1:25-year dry conditions).

Based on the collected field data and available regional climate, topographical and land cover information, a hydrological model was constructed in GoldSim. The model was configured to simulate surface water flow and storage through the lakes in the Local Study Area. Five iterations of the model were developed to simulate hydrological response during Existing Conditions, the operations phase, post-closure phase stage I and post-closure phase stage II. The operations phase model simulated treated effluent discharge to two potential receiving waterways (Bagsverd Creek and Mesomikenda Lake). The average annual surface water flows for the operation phase and post-closure phase were compared to the Existing Conditions to provide a predicted change in surface water flow. Predicted effects associated with the construction phase were developed qualitatively.

Changes to surface water flow during the construction phase will be limited to those associated with the development of the realignment features (channels and dams). These realignment features will be designed to manage the expected range of flows and were assessed in the context of the full Project site footprint at the operations phase.

For the operations phase, the greatest predicted changes in average annual surface water flow were the result of planned realignment features, where headwater lakes will be connected to larger contributing watersheds or where realignment channels replace existing lake outflow features. Along a portion of Bagsverd Creek, the loss of upstream watershed area attributable to realignment and the development of the TMF was predicted to decrease average annual surface water flow by greater than 10%. This flow decrease was qualitatively considered unlikely to alter in-stream characteristics such as sedimentation, or the connection to downstream waterways beyond the existing variation in observed conditions, and a monitoring plan was developed to verify this qualitative assessment.

For the post-closure phase stage I, active pumping of site water ceases (other than from the seepage ponds associated with the MRA, which will continue pumping to facilitate the flooding of the open pit). Average annual surface water flow remained similar to the operations phase, a result of a similar watershed configuration. Flow in a portion of Bagsverd Creek maintained the greater than 10% decrease, predicted in the operations phase. However, this flow decrease was qualitatively considered unlikely to alter in-stream characteristics such as sedimentation, or connection to downstream waterways beyond the existing variation in observed conditions. A monitoring plan was developed to verify this qualitative assessment.

During post-closure phase stage II, active pumping will be discontinued across the Project site and the watershed realignments will be reconfigured to allow water to flow through the restored Côté Lake. Under this



scenario, surface water flow was generally similar to Existing Conditions, except in locations that remain connected to realignment channels or downstream of watershed area change (a portion of Bagsverd Creek).

Several inherent mitigation measures have been included in the design of the Project, and have been considered in the prediction of effects. The following mitigation measures have been incorporated to reduce effects on surface water flow as a result of the Project:

- Engineered facilities will be constructed to store mine rock (MRA), ore at the low-grade stockpile and tailings (TMF).
- Engineered water management systems will be constructed to collect runoff and seepage from the MRA, low-grade stockpile, TMF, and polishing pond during the operations phase and post-closure phase stage I.
- Engineered realignment channels will be constructed to convey the range of flows that can be reasonably expected over the projected life of mine or life of realignment feature as applicable.
- Contact water comprised of inflows and runoff from the pit walls, runoff and seepage from the MRA and low-grade stockpile, and runoff from the processing plant will be collected and pumped to the mine water pond during the operations phase and pumped to the open pit during the post-closure phase stage I. Contact and process water contained within the TDSPs and polishing pond collection ponds will be pumped back into the reclaim pond and polishing pond (respectively) during the operations phase.
- A low-permeable liner will be installed at the mine water pond.
- Erosion and sediment control measures will be constructed to promote settling of sediments and mitigate the migration of suspended solids into nearby surface water features.

A monitoring plan has been developed to continue the collection of data required to assess changes in surface water flow prior to, and during the life of the Project. Specific commitments for conducting this program are:

- 1) Continued measurement of streamflow and water level at selected existing locations and new locations, as required, in the waterways around the infrastructure footprint. These monitoring locations will be equipped with dataloggers and will be measured quarterly for surface water flow. The location of the new monitoring stations may be aligned with groundwater monitoring to monitor interactions between groundwater and surface water, and will also consider the realigned channels.
- 2) The continued collection of meteorological monitoring at the Project site with the use of the installed meteorological tower. The station will be downloaded quarterly and checked for data consistency and comparison with regional climate monitoring stations and previously established spatial trends.
- 3) A supporting monitoring program focussed on a portion of Bagsverd Creek. The monitoring program will be completed twice annually, following snowmelt and at low flow conditions, and will be initiated prior to realignment development to establish existing conditions. The monitoring will include:
 - a. Total Suspended Solids (TSS) sampling for suspended solids concentrations;
 - b. stream cross-sections at several locations for channel geometry;



- c. installation of erosion pins in stream banks and disturbance rods in the streambed to assess sedimentation and erosion; and
 - d. aerial or photographic analysis to assess stream meander.
- 4) This program is to be integrated with the monitoring programs developed for the Water Quality, Hydrogeology, Aquatic Biology and Terrestrial Ecology disciplines, as documented in their respective TSDs which have been submitted under a separate cover.

Annually the results of this surface water monitoring program will be integrated with the results obtained from disciplines noted above and assessed in consideration of ongoing operational activities, as well as closure and post-closure.



Table of Contents

1.0 INTRODUCTION..... 1

1.1 Project Overview..... 1

1.1.1 Open Pit..... 2

1.1.2 Mine Rock Area 2

1.1.3 Low-Grade Stockpile..... 2

1.1.4 Tailings Management Facility..... 2

1.1.5 Processing Plant..... 3

1.1.6 Mine Water Pond and Polishing Pond..... 3

1.1.7 Watercourse Realignments..... 3

1.1.8 Project Site Water Management 4

2.0 METHODOLOGY..... 5

2.1 Effects on Hydrology..... 5

2.2 Study Areas (Spatial Boundaries)..... 5

2.2.1 Local Study Area..... 6

2.2.2 Regional Study Area 6

2.3 Project Phases (Temporal Boundaries) 6

2.4 Selection of Effects Assessment Indicators 7

2.5 Background Review 7

2.6 Field Study Methods 8

2.7 Effects Prediction..... 8

3.0 EXISTING CONDITIONS 9

3.1 General Setting..... 9

3.1.1 Mattagami River Water Management Plan 9

3.1.2 Mattagami River Source Water Protection Plan..... 10

3.2 Local Climate Conditions 10

3.3 Local Hydrological Conditions..... 10

3.4 Hydrological Model Overview 12

3.5 Simulation of Existing Conditions..... 12

4.0 PREDICTION OF EFFECTS..... 14



4.1 Predicted Changes in Surface Water Flow 14

4.1.1 Construction Phase..... 14

4.1.2 Operations Phase 14

4.1.2.1 Model Output – Operations Phase..... 14

4.1.3 Post-Closure Phase Stage I..... 18

4.1.3.1 Model Output – Post-Closure Phase Stage I 18

4.1.4 Post-Closure Phase Stage II 20

4.1.4.1 Model Output – Post-Closure Phase Stage II 21

4.2 Other Predicted Effects..... 23

5.0 MITIGATION AND MONITORING 23

5.1 Mitigation 23

5.2 Monitoring..... 23

5.2.1 Hydrological Monitoring..... 24

5.2.2 Meteorological Monitoring 24

5.2.3 In-Stream Characteristics – Bagsverd Creek 24

6.0 CONCLUSIONS..... 25

7.0 REFERENCES..... 26

TABLES

Table 2-1: Effects Assessment Indicators Selected for Hydrology 7

Table 3-1: Mesomikenda Lake Dam - Operating Rules 9

Table 3-2: Estimated Annual Precipitation Statistics 10

Table 3-3: Observed Surface Water Flow and Water Level Range, 2012 - 20131..... 11

Table 3-4: Existing Conditions Average Annual Surface Water Flow 13

Table 4-1: Operations Phase Estimated Watershed Areas 14

Table 4-2: Percent Change in Average Annual Surface Water Flow, Operations Phase, Treated Effluent Discharged to Mesomikenda Lake 15

Table 4-3: Percent Change in Average Annual Surface Water Flow, Operations Phase, Treated Effluent Discharged to Bagsverd Creek..... 16

Table 4-4: Percent Change in Average Annual Surface Water Flow, Post-Closure Phase Stage I..... 18

Table 4-5: Percent Change, Average Annual Surface Water Flow, Post-Closure Phase Stage II 21



FIGURES

Figure 1-1: Project Location

Figure 1-2: Site Plan

Figure 2-1: Hydrology Local Study Area

Figure 2-2: Hydrology Regional Study Area

Figure 2-3: Local Hydrological Monitoring Locations (Southern Portion)

Figure 2-4: Local Hydrological Monitoring Locations (Northern Portion)

Figure 2-5: Effects Assessment Locations

Figure 3-1: Existing Conditions Flow Schematic

Figure 4-1: Operations Phase Flow Schematic

Figure 4-2: Post-Closure Phase Stage I Flow Schematic

Figure 4-3: Post-Closure Phase Stage II Flow Schematic

ATTACHMENTS

Attachment I

Hydrology Baseline Report, Côte Gold Project

ATTACHMENT II

Hydrological Modelling Report, Côte Gold Project



ABBREVIATIONS

°C	degrees Celsius
3D	3- dimensional
AMEC	AMEC Environment & Infrastructure
EA	Environmental Assessment
EAI	effects assessment indicator
EC	Environment Canada
EIS	Environmental Impact Statement
ha	hectare
K	hydraulic conductivity
km	kilometre
km/h	kilometres per hour
L/m	litres per metre
L/s	litres per second
LSA	Local Study Area
m	metre
m/day	metre per day
m/s	metre per second
m ²	metres squared
m ³	cubic metres
m ³ /d	cubic metres per day
m ³ /s	cubic metres per second
m ³ /yr	cubic metres per year
mags	metre above ground surface
masl	metre above sea level
mbgs	metre below ground surface
mg/kg	milligrams per kilogram
mm	millimetre
MNR	Ministry of Natural Resources
MRA	Mine Rock Areas
MRSP	Mine Rock Storage Ponds
MRWMP	Mattagami River Water Management Plan
Mt	million tonnes
MTO	Ministry of Transportation
OSSP	Ore Stockpile Seepage Ponds
PTTW	Permit to Take Water
RSA	Regional Study Area
TDSP	Tailing Dam Seepage Ponds
TMF	Tailings Management Facility
tpd	metric tonnes per day
TSD	Technical Support Document
WSC	Water Survey of Canada



1.0 INTRODUCTION

This Technical Support Document (TSD) was prepared by Golder Associates Ltd. (Golder) and comprises an Appendix of the Environmental Impact Statement (EIS) of the IAMGOLD Corporation (IAMGOLD) Côté Gold Project (the Project). This TSD presents detailed information on the existing conditions and the predicted environmental hydrological effects associated with the Project. Predicted effects on hydrology have been incorporated into the effects assessment for the Water Quality TSD as well as that of the Aquatic Biology TSD. The significance of the assessed effects of the Project related to hydrology and associated disciplines are presented in the main body of the EIS.

1.1 Project Overview

IAMGOLD intends to develop the Côté Gold Project in the District of Sudbury, in northeastern Ontario, approximately 20 kilometres (km) southwest of Gogama, 130 km southwest of Timmins, and 200 km northwest of Sudbury (shown on Figure 1-1). The area is characterized by exposed bedrock, gentle hills, forests, lakes and rivers typical of northern Ontario. The Project site is located in two watersheds defined for this study, the Mollie River system and the Mesomikenda Lake system. Additionally, the watershed divide between the Great Lakes and James Bay watersheds lies about 3.5 km to the southwest of the Project footprint. Land use in the area consists of recreational activities by locals and tourists, including fishing, camping and hunting. It is also used for sustainable harvesting of timber.

IAMGOLD proposes to construct, operate and eventually rehabilitate a new open pit gold mine and ore processing facility with associated infrastructure.

A complete description of proposed Project activities and infrastructure is presented in the main body of the EIS. For the purposes of the hydrology TSD, a brief description of the Project components and associated activities that have the potential to affect the hydrological environment is presented below and includes:

- blasting, excavation and dewatering of a 550 metre (m) deep open pit mine;
- development of a 450 ha mine rock disposal area (MRA) and associated perimeter runoff and seepage collection facilities;
- temporary storage of low grade ore (low-grade stockpile) located to the northeast of the pit;
- development of a 840 hectare (ha) tailings management facility (TMF), polishing pond and associated perimeter runoff and seepage collection facilities;
- ore beneficiation and discharge of water from the processing plant to the TMF;
- management of site runoff and seepage through the use of collection ponds and a mine water pond located adjacent to the processing plant;
- realignment of various surface water features and construction of associated dams;
- operation of domestic sewage works and treatment system associated with the camp site and plant facilities; and
- a low-grade ore stockpile.



The key Project components are presented in Figure 1-2 and discussed further below.

1.1.1 Open Pit

As part of the proposed development, Côté Lake will be drained and the upstream watershed will be realigned around the open pit, including the requirement for dams at some lakes to redirect water and control seepage in the vicinity of the pit perimeter as further discussed in Section 1.1.7.

The current open pit design proposes a final pit area of approximately 210 ha with a depth of approximately 550 m. Open pit mining will occur at a mining rate of approximately 60,000 tonnes per day of ore production. Extraction of the ore through pit development will result in the production of an estimated 20 million tonnes (Mt) of overburden and 850 Mt of mine rock. Water from the open pit will be pumped to the mine water pond.

1.1.2 Mine Rock Area

The MRA is located approximately 250 m southeast of the open pit and occupies an area of approximately 450 ha. The MRA is bound by Three Duck Lakes to the east, the open pit (formerly Côté Lake) to the northwest, Chester Lake to the west and Delaney Lake to the south.

The Mollie River, which flows northward adjacent to this area, will be re-aligned to flow into Clam Lake at the west side of the open pit. A forestry access road (Chester Road) traverses the MRA north to south along the western side of the footprint. A portion of this road will need to be relocated.

A series of 15 collection ponds (Mine Rock Storage Ponds; MRSPs) with connecting ditches are to be constructed around the perimeter of the MRA to collect runoff and toe seepage.

1.1.3 Low-Grade Stockpile

Low-grade ore will be stockpiled to the north of the open pit and east of the processing plant as shown on Figure 1-2. Approximately 2 km of water collection ditches and four ore stockpile storage ponds (OSSPs) will be constructed to collect runoff and toe seepage at the perimeter of the stockpiles, with water pumped back to the mine water pond. Perimeter containment berms (where required for the storage ponds) will be constructed with geomembrane liners and protected with non-woven geotextile to prevent seepage losses to the underlying groundwater table and adjacent open pit.

1.1.4 Tailings Management Facility

The TMF will have an area of approximately 840 ha and will be designed to store approximately 193 million cubic metres (m^3 ; 261 Mt) of tailings solids. Tailings dams will be constructed primarily with waste rock and will comprise approximately 90 percent of the total perimeter length of the TMF. Tailings will be discharged from perimeter containment dams with drainage directed towards a central reclaim pond.

The dam design incorporates approximately 94,200 metres squared (m^2) of geomembrane liner, protected by a non-woven geotextile cushion layer to minimise seepage losses from the starter dams.



Seepage losses from the TMF and runoff from the tailings dams will be collected at six Tailings Dam Seepage Ponds (TDSPs) and associated ditches located at the downstream toe of the tailings dams, with the collected seepage water pumped back to the reclaim pond. Water collected in the reclaim pond will be recycled for use at the processing plant.

1.1.5 Processing Plant

The ore processing plant will be located to the northwest of the open pit. Ore beneficiation will consist of crushing and grinding, including coarse gold recovery by gravity, cyanide leaching, carbon-in-pulp recovery, followed by carbon stripping and electro-winning. The tailings produced from ore processing, which will contain some residual cyanide and dissolved metals, will be directed to an in-plant cyanide destruction and precipitation circuit. Prior to discharge to the TMF, process water and tailings will be treated at the process plant for cyanide, dissolved metals and potentially ammonia.

A pipeline delivering tailings slurry at an approximate rate of 56,000 m³/day and a slurry density of approximately 51% solids by mass will result in approximately 35,000 m³/d of supernatant water (water not held in tailings pore space) discharged to the TMF reclaim pond.

1.1.6 Mine Water Pond and Polishing Pond

Contact water from the open pit, the MRA, low-grade stockpile, toe seepage collected at dams in the vicinity of the open pit and runoff from the area of the processing plant and associated facilities will be directed to the mine water pond. This water will be used for ore processing and other demands such as dust control. The mine water pond design incorporates a high density polyethylene geomembrane liner to prevent seepage losses from the pond to the underlying groundwater table and adjacent open pit.

The polishing pond is located to the north of the TMF. Excess water in the mine water pond will be directed to the polishing pond for additional removal of suspended solids. Subsequently, water in the polishing pond will be pumped back for use at processing plant, directed to the TMF reclaim pond (when storage is available) or treated effluent will be discharged to the environment in accordance with federal and provincial effluent discharge requirements. Bagsverd Creek and Mesomikenda Lake have both been identified as potential receivers for treated effluent discharged from the polishing Pond. Seepage losses from the polishing pond will be collected at seepage ponds and associated ditches at the downstream toe of the containment dam, with the collected seepage water pumped back to the polishing Pond.

1.1.7 Watercourse Realignments

The local watercourses and lakes, including flow directions, in the vicinity of the Project are shown on Figure 1-2. The Project will overprint several water features; these include Côté Lake, and portions of Bagsverd Creek, Bagsverd Lake, Three Duck Lakes, Clam Lake, Chester Lake and the Mollie River. Project construction requires the realignment of Weeduck Lake, Clam Lake, Unnamed Lake #2 and parts of the Mollie River, Bagsverd Creek and Bagsverd Lake.



Watercourse realignments were selected to:

- minimize the overall Project environmental footprint, while at the same time considering economic efficiency of the Project;
- minimize disturbance of the existing water flow regime and existing aquatic habitat, thereby also minimizing disturbance on existing terrestrial flora and fauna;
- minimize disturbance of existing land use; and
- minimize water transfer between the Mollie River and the Mesomikenda Lake watersheds.

A total of six realignments are planned, totalling approximately 7.9 km of constructed channels.

For surface water flow associated with the Mollie River, the outflow from Chester Lake will be diverted northwards via an approximately 2.2 km long constructed channel to Clam Lake. Flow will be directed northwards along the west side of the open pit to Little Clam Lake and then via a short constructed channel to an existing stream and wetland area that drains eastwards to Bagsverd Lake. The southern portion of Bagsverd Lake will be dammed (and isolated from the larger northern portion) with a constructed channel directing flow southward through Weeduck Lake and Three Duck Lakes.

In the vicinity of the TMF, the northern portion of Bagsverd Lake will be connected to Un-named Lake #2 via an approximately 4.3 km long constructed channel. Flow then discharges east to Un-named Lake #1 and reconnects to Bagsverd Creek immediately north of the TMF.

At closure, the realignment structures are expected to remain in place until such time as the water quality is suitable for release to the environment and the open pit is flooded. At that point in time, it is then envisaged that changes to realignment features will be completed to restore surface water flow paths similar to pre-development conditions.

1.1.8 Project Site Water Management

The construction of mine components outlined above will require active management of on-site water. Briefly, the water management system at the Project Site consists of:

- A total process water demand at the processing plant of approximately 56,000 m³/day, of which a minimum of 840 m³/day of freshwater is drawn from Mesomikenda Lake;
- A mine water pond, which will provide the ore processing plant with recycled water collected from runoff and seepage at the MRA, low-grade ore stockpile, open pit dewatering and local runoff collection facilities, or will be discharged to the polishing pond;
- A TMF reclaim pond that receives the water discharged in tailings slurry not retained in pore space (approximately 35,000 m³/day), and subsequently provides reclaim water to the processing plant; and
- A polishing pond that receives water from the mine water pond and is capable of recirculating water to the ore processing plant, the TMF reclaim pond or discharging treated effluent to the environment (Bagsverd Creek or Mesomikenda Lake) when required.



2.0 METHODOLOGY

The prediction of Project related effects on hydrology includes the following tasks, which are further described in following sections:

- identify the Project interactions with the hydrology environment;
- define the spatial and temporal boundaries over which the effects prediction is to be conducted;
- select effects assessment indicators that are representative of hydrology;
- characterize the existing hydrological conditions of the area; and
- predict changes in surface water flows.

2.1 Effects on Hydrology

The primary Project components and associated activities that could potentially affect the hydrological environment include:

- excavation and dewatering of the open pit mine covering approximately 210 ha with a final depth of approximately 550 m;
- construction of watercourse realignments;
- construction of perimeter dams at lakes adjacent to the open pit and associated seepage collection facilities;
- development of a MRA covering an area of approximately 450 ha for stockpiling overburden and mine rock, and associated perimeter seepage collection facilities; and
- development and operation of a TMF and polishing pond covering an area of approximately 900 ha and associated perimeter seepage collection facilities.

Other mine facilities, including the ore processing plant and associated infrastructure, aggregate extraction sites, solid waste disposal facilities (landfill), domestic sewage works, storage facilities for ore, fuels, chemicals and explosives, and the accommodations complex may also have a minor and localized effect on hydrology and have not been explicitly assessed herein.

The locations of the primary Project components are provided on Figure 1-2.

2.2 Study Areas (Spatial Boundaries)

The hydrological study areas define the spatial boundaries within which the physical works and activities of the Project could potentially affect the hydrological environment. Two study areas have been selected for the prediction of Project related effects on the hydrology: the Local Study Area (LSA) and the Regional Study Area (RSA). These areas are described in the following sections.



2.2.1 Local Study Area

The LSA includes an area beyond the location of the physical works and activities within which effects may occur as a result of the Project. For hydrology, the LSA is defined by lakes and watersheds in the vicinity and downstream of the Project infrastructure and covers an area of approximately 22,100 ha. Project effects on hydrology are not expected to occur in watersheds upstream of the planned infrastructure. As such, the hydrology LSA extends to the nearest watershed boundary beyond the proposed infrastructure, open pit, MRA and TMF. The LSA is bound by the following features:

- the Great Lakes/James Bay watershed divide along the south;
- the Chester Lake and Bagsverd Lake inflow to the west;
- Mesomikenda Lake to the east; and
- the Somme River system associated with the Neville Lake Watershed to the north and northwest.

The hydrology LSA is shown on Figure 2-1.

2.2.2 Regional Study Area

The RSA for hydrology was extended downstream of the Project to the confluence of the Mollie River and the Mesomikenda Lake outflow. These waterways both ultimately discharge to Minisinakwa Lake near the community of Gogama and subsequently to the Mattagami River. The Mattagami River is a controlled river system with approximately 18 dams along its length which provide flood control and power generation. A Water Survey of Canada water level gauge exists at Minisinakwa Lake Dam, and the total watershed area upstream of this monitoring point was defined as the RSA.

The hydrology RSA is shown in Figure 2-2.

2.3 Project Phases (Temporal Boundaries)

Project activities and the areas over which these activities are conducted necessarily vary throughout the Project; thus, the effects of project related activities vary throughout the Project phases. In general, the potential effects on hydrology are expected to be greatest at the end of mining when the open pit, TMF, MRA and low-grade stockpile are fully developed and have reached their ultimate extents. As such, the predictions of potential effects on hydrology focused on two Project phases: operations phase and post-closure phase. The post-closure phase was further divided into stage I and stage II to assess the effects to hydrology during post-closure when the pit is flooding and after the pit is flooded to form the Côté Pit Lake. During stage II of the post-closure Phase, the Mollie River system will receive overflow from the MRA collection ponds (if water quality is acceptable) and flow pathways will be restored to flow through Clam Lake and Côté Pit Lake, and subsequently to Three Duck Lakes.

The changes in surface water flow that may occur during the construction phase, if any, will be associated with the development of the Project infrastructure. Surface water flow changes during the construction phase are assumed to be minor relative to any changes that may occur due to the ultimate operations phase. As such,



specific temporal boundaries for the construction and closure phases have not been established for the hydrological assessment. Potential changes anticipated to be associated with the construction phase are discussed qualitatively and relative to those predicted for the operations and post-closure phases.

2.4 Selection of Effects Assessment Indicators

The effects assessment indicator (EAI) selected for hydrology and the rationale for selection of this indicator are presented in Table 2-1.

Table 2-1: Effects Assessment Indicators Selected for Hydrology

Effect Assessment Indicator	Rationale for Selection
Changes in surface water flow	A change in surface water flow can affect hydrological (in-stream) characteristics.

Surface water flow was identified as the EAI for Project-related effects on hydrology. This indicator was identified as important, based on feedback received from consultation and engagement activities conducted by IAMGOLD. Surface water flow will potentially be affected in the vicinity of the Project by the taking of the process water supply and watershed reconfiguration through the construction of various Project components such as watercourse realignments, the TMF and the MRA.

The rationale for selection of the hydrology EAI is the role that surface water flow plays in the potential effect on in-stream hydrological characteristics such as sedimentation and erosional processes. Surface water flow is currently monitored at established hydrological installations. Over time, changes in these flows may indicate naturally occurring fluctuations and/or reflect the effects of Project related activities and/or facilities. It is recognized that surface water flow can influence a number of other disciplines, and as such the results of the hydrological assessment were passed on to other disciplines (including water quality and aquatic biology) and used in their respective effects predictions.

2.5 Background Review

Available information in the vicinity of the Project Site that was reviewed, includes:

- climatological and meteorological statistics for regional climate data collection sites at Sudbury, Timmins, Chapleau and North Bay (Environment Canada [EC]);
- regional hydrological information (water flow and level statistics) for nearby northern Ontario waterways (Water Survey of Canada [WSC]);
- hydrological and hydraulic information for Mesomikenda Lake (Ontario Power Generation Inc. [OPG]);
- river management and operational strategies (The Mattagami River Water Management Plan [MRWMP]); and
- bathymetric data for Mesomikenda Lake (Ontario Ministry of Natural Resources [MNR]).



Based on this review, a site inspection and the Project Description, a field program was developed and implemented to characterise the hydrological conditions at the Project as outlined in the following sections.

2.6 Field Study Methods

Fourteen hydrological monitoring locations were installed in the LSA with automatic water level pressure dataloggers and manual staff gauges in 2012 (Figure 2-3 and Figure 2-4). Streamflow measurements were made by IAMGOLD and/or Golder personnel at each location (either monthly or quarterly) through standard velocity-area methods, using a wading rod and velocity meter. Bathymetric data was supplied by IAMGOLD and MNR and supplemented with additional field information collected by Golder in 2013.

To initiate the collection of long-term climate data for the Project area, an on-site meteorological tower was installed in May 2012 (Figure 2-3). This climate station was downloaded approximately quarterly and includes a datalogger connected to sensors for total precipitation, air temperature, relative humidity, wind speed, wind direction and solar radiation. The sensors and datalogger were mounted on, or adjacent to, a 10 m aluminum tower.

Details on the baseline data collection and results are summarized in the Hydrology and Climate Baseline Report, Côté Gold Project in Attachment I.

2.7 Effects Prediction

A hydrological model was completed in GoldSim, a simulation program that allowed for the construction of lake water balances. This model accounted for the seasonal and annual change in flow and storage of water in watersheds, lakes and on-site constructed ponds around the Project site.

Discharge from lakes incorporated into the model was estimated from rating curves developed through monitored discharge locations as well as from topographic and bathymetric information. Discharge from Mesomikenda Lake was based on the operational rules from the MRWMP and hydraulic information provided by OPG.

Inputs to the GoldSim model included a long-term climate record developed from on-site and regional climate stations (total precipitation and air temperature), watershed and lake areas, land cover type and discharge rating curves. Five iterations of modelling were completed to simulate the response of surface water features at the Project site during Existing Conditions, the operations phase, post-closure phase stage I and post-closure phase stage II. For operational phase modelling, effluent from the Polishing Pond was simulated to be discharged to either Mesomikenda Lake or Bagsverd Creek. Details of the model construction, assumptions and results of simulations are provided in Attachment II.

Predicted effects on surface water flows were simulated at assessment locations throughout the LSA. These assessment locations were selected based on i) areas downstream to the Project site footprint (where there was potential for watershed change during the life of the Project) and ii) the connection to realignment channels (where there was potential for flow conveyance change). These assessment locations are displayed on Figure 2-5.



3.0 EXISTING CONDITIONS

3.1 General Setting

The Project site is located in Chester and Neville Townships, approximately 20 km southwest of the town of Gogama, Ontario, in the headwaters of the Mattagami River system, just north of the watershed divide that separates the James Bay watershed from the Great Lakes watershed. Downstream of the Project site, the Mattagami River flows for approximately 420 km to a confluence with Moose River, which subsequently flows to James Bay. The Mattagami River is a managed river system that includes approximately 18 dams and power generating stations that fall under the MRWMP.

A number of lakes, connected by relatively short streams, are present on the Project site and within the LSA. The Mollie River, fed by Chester and Clam Lakes to the west, flows eastward through the open pit footprint and connects Côté Lake to the Three Duck Lakes system. Lake elevations decrease from about 386 metres above sea level (masl) at Clam Lake to the west to 381 masl at the Three Duck Lakes reflecting the low topographic gradient eastwards across the area of the proposed open pit. To the north of the open pit footprint, Bagsverd Lake drains northward through Bagsverd Creek that discharges into Mesomikenda Lake to the east. Other than Mesomikenda Lake, which is greater than 50 m deep in some locations, lakes are typically shallow (<10 m average depth) with bedrock-lined shorelines.

There are no recorded surface water Permits to Take Water (PTTW) in the LSA.

Active regional climate monitoring locations are located in the vicinity of the Project Site in Timmins (120 km north of the Project site), Chapleau (120 km NW of the Project site), Sudbury (140 km south of the Project site) and North Bay (230 km NW of the Project site). Based on information collected at these locations, the climate of the Project site is characterized by cold winters (-10°C to -35°C) and warm summers (10°C to 35°C). Mean annual precipitation for the region is approximately 800 mm to 900 mm, of which approximately 30 to 40% falls as snow (EC 2013). Mean annual evaporation is in the range of 400 mm to 600 mm (MNR 1984).

3.1.1 Mattagami River Water Management Plan

As described by MNR et al. (2006), the MRWMP was developed to allow a sustainable management of the river based on the concerns of various stakeholders. The MRWMP mandates operating levels for 18 dams and generating stations located in the Mattagami River watershed. The operational procedures for the Mesomikenda Lake Dam (owned by OPG) are such that the key drawdown period is during winter to provide storage for spring melt and reduce spring runoff peaks. Lake level is to be subsequently raised from the winter target minimum water elevation to its summer target operating range by the time water temperature reaches 5°C. The summer target operating range is to be maintained through to mid-summer for wildlife (waterfowl nesting) and walleye spawning purposes (Table 3-1).

Table 3-1: Mesomikenda Lake Dam - Operating Rules

Normal Operating Range (masl)	Summer Target Operating Range (Victoria Day to Thanksgiving) (masl)	Winter Target Minimum Elevation (masl)
362.30 – 365.30	364.94 – 365.30	362.30

Note:
masl = metres above sea level



3.1.2 Mattagami River Source Water Protection Plan

The Mattagami River Conservation Authority (MRCA) has completed a proposed Source Water Protection Plan intended to minimize and mitigate potential threats to the drinking water supply for the City of Timmins (Mattagami Region Source Protection Committee 2012). The Mattagami River serves as the source for municipal water in Timmins, and the Project site is located 110 km upstream of the Timmins municipal water intake, and is adjacent to, or within areas referred to as the Intake Protection Zone (IPZ)-3. The IPZ-3 for the Timmins municipal water drinking source was defined as a 120 m setback from rivers upstream of the municipal intake. In the case of the Timmins municipal intake, the IPZ-3 borders rivers and lakes that extend to the James Bay/Great Lakes watershed divide. To date, the MRCA have been consulted and have requested to be updated with Project progress and development plans.

3.2 Local Climate Conditions

Local meteorology has been compiled for the Project site for the period May 2012 to May 2013, and daily temperature and precipitation has been compared to regional climate stations. This on-site data and long-term regional station datasets were used to estimate annual precipitation statistics for an average annual condition, a 1:25-year annual dry precipitation condition to a 1:25-year annual wet precipitation condition (Table 3-2).

Table 3-2: Estimated Annual Precipitation Statistics

Description	Wet Conditions Annual Total Precipitation (mm)	Average Conditions Annual Total Precipitation (mm)	Dry Conditions Annual Total Precipitation (mm)
Return Period	1:25-year	1:2-year	1:25-year
Côté Gold Project Site	989.5	856.3	734.1

Note:
mm = millimetres

Regional climate data and local meteorological data were used to produce an estimated daily record of rainfall, snow and temperature for the period 1970 to 2012 (42 years). This site-specific climate record was subsequently used as an input to the GoldSim model (Attachment II).

3.3 Local Hydrological Conditions

The Project lies within two watersheds that were defined for this study; the Mollie River and Mesomikenda Lake. The Mollie River watershed was defined as the contributing area upstream of the Mollie River at its crossing with Highway 144, an area of approximately 9,000 ha. The Mollie River connects a chain of lakes that discharge through the open pit and MRA areas. The headwaters of the river include Moore Lake, which discharges sequentially through Attach Lake, Chester Lake, Côté Lake and Three Duck Lakes. Outflow from other lakes also contribute to the Mollie River, such as Clam Lake (downstream of Chester Lake), Weeduck Lake (upstream of Three Duck Lakes), Delaney Lake (downstream of Three Duck Lakes) and smaller headwater ponds. The Mollie River discharges to Dividing Lake and east of Highway 144 to Lake Minisinakwa near the town of



Gogama. An operational WSC monitoring site is located where the Mollie River crosses Highway 144 (Figure 2-3).

The Mesomikenda Lake watershed is defined by the contributing area upstream of the Mesomikenda Lake dam (approximately 64,000 ha). This watershed drains two primary tributaries in the vicinity of the Project site; the Somme River and Bagsverd Creek, each of which discharge to Neville Lake and subsequently to Mesomikenda Lake. The Somme River drains several lakes located to the west, southwest and northwest of the Project site (e.g. Somme Lake; Wolf Lake). Bagsverd Creek headwaters are located at Schist Lake and the creek flows north through the Project site. Bagsverd Creek receives discharge from Bagsverd Lake and other un-named lakes that have been given identification codes for the purposes of this study. Mesomikenda Lake in turn discharges to the Makani River and Minisinakwa Lake near the town of Gogama. In this respect, each of these watersheds confluence at Minisinakwa Lake, which in turn ultimately discharges to the Mattagami River.

The water level range and discharge have been monitored in selected lakes and streams in the LSA and the range in observed water level and surface water flow during the 2012 field program is summarized (by watershed and generally from outflow to upstream) in Table 3-3. Monitoring locations are displayed on Figure 2-3 and Figure 2-4.

Table 3-3: Observed Surface Water Flow and Water Level Range, 2012 - 20131

Watershed	Location	Average Water Level (masl)	Water Level Range (m)	Maximum Observed Flow (L/s)	Minimum Observed Flow (L/s)	Average Observed Flow (L/s)
Mesomikenda Lake	Somme River Outflow	371.9	1.1	8,460	870	3,530
	Bagsverd Creek Outflow	369.5	0.6	3,610	190	1,100
	Bagsverd Creek Downstream of Un-named Lake #1	372.6	1.9 ²	1,660	300	740
	Un-named Lake #2 Outflow	373.3	0.6	180	<1	70
	Bagsverd Lake Outflow	379.9	0.7	1,310	10	480
	Schist Lake Outflow	380.5	0.6	820	120	380
	Little Clam Lake Outflow	387.7	0.5	4	0	1
Mollie River	Three Ducks Lake Outflow	380.5	0.9	2,530	10	640
	Weeduck Outflow	381.3	0.6	n/a ²	n/a	n/a
	Côte Lake Outflow	380.8	0.9	1,280	40	540
	Clam Lake Outflow	386.2	0.6	3	3	3



Watershed	Location	Average Water Level (masl)	Water Level Range (m)	Maximum Observed Flow (L/s)	Minimum Observed Flow (L/s)	Average Observed Flow (L/s)
	Chester Lake Outflow	384.9	1.1	160	50	100

Notes:

masl = metres above sea level

mm = millimetres

L/s = litres per second

¹ Period of record depends on location (Attachment I)

² Culverts are submerged and blocked, flow is assumed to be primarily seepage across road embankment

3.4 Hydrological Model Overview

A hydrological model was constructed in GoldSim based on the conceptual understanding of the Project site hydrology developed from the baseline characterization, as outlined in Section 3.1. Details of the model construction, assumptions and simulation results are provided in a Côté Gold Project Hydrological Model, Report included herein as Attachment II.

The hydrological model was constructed with the existing surface water flowpaths, and was subsequently modified to incorporate the water course realignments, the Project footprint and on-site water management associated with the open pit, the MRA and MRSPs, Low Grade Ore Stockpile and OSSPs, mine water pond, TMF reclaim pond and the polishing pond.

Model simulations were completed for the Existing Conditions and flow results were subsequently compared to simulated surface water flow produced during the operations phase, post-closure phase stage I and post-closure phase stage II. The latter three scenarios considered the changes associated with on-site water management as well as changes to the natural flow system (through realignments).

Model results were presented for an average annual precipitation climate condition, as well as 1:25-year wet and 1:25-year dry annual precipitation climate conditions. The 1:25-year climate conditions were considered representative of the range of annual climate conditions that may be encountered at the Project site for the life of the mine (approximately 15 years). For the estimated Côté Gold climate record (1970 to 2012), results were compiled for simulated years that best matched the specified annual precipitation return periods (Table 3-2).

3.5 Simulation of Existing Conditions

Model simulations were completed for the Existing Conditions and were based on the available baseline information and assumptions as described in Attachment I and Attachment II. Surface water flow schematic is displayed in Figure 3-1. Average annual surface water flow is summarized in Table 3-4 for existing conditions at Assessment Locations noted on Figure 2-4.



Table 3-4: Existing Conditions Average Annual Surface Water Flow

Watershed	Location	Average Annual Surface Water Flow (m ³ /day)		
		Wet Climate Conditions	Average Climate Conditions	Dry Climate Conditions
		1:25-year		1:25-year
Mesomikenda Lake	Mesomikenda Lake Outflow	614,000	498,600	360,200
	Neville Lake Outflow	293,500	234,400	160,400
	Somme River Outflow	200,700	155,300	106,800
	Effluent Discharge at Bagsverd Creek ¹	86,800	69,500	50,600
	Bagsverd Creek upstream of Effluent Discharge	85,100	68,200	49,500
	Un-named Lake #2 Outflow	12,000	10,000	7,000
	Bagsverd Lake Outflow	42,100	34,000	22,700
	Schist Lake Outflow	29,700	24,700	16,100
	Little Clam Lake Outflow	300	200	200
Mollie River	Dividing Lake Outflow	103,200	79,700	61,400
	Delaney Lake Outflow	9,700	7,500	5,800
	Three Duck Lakes Outflow	64,400	50,100	38,300
	Weeduck Outflow	800	800	500
	Côté Lake Outflow	49,500	39,000	30,600
	Clam Lake Outflow	3,700	3,100	2,000
	Chester Lake Outflow	40,100	31,500	25,200

Note:

m³/day - cubic metres per day

¹ No effluent discharge under Existing Conditions, Assessment Point for comparison purposes only

Estimated average annual discharge varied across the Project site by up to three orders of magnitude, with flow through the Mesomikenda Lake watershed exceeding flow through the Mollie River (as indicated by flow at the Dividing Lake Outflow in Table 3-4) watershed by greater than 400,000 m³/day under average annual conditions. Corresponding simulated average annual water level for lakes at the Project site are included in Attachment II.



4.0 PREDICTION OF EFFECTS

4.1 Predicted Changes in Surface Water Flow

Predicted changes to surface water flow for the construction phase were considered qualitatively. Estimated annual average surface water flow at the selected Assessment Locations for the operations phase and the post-closure phase were summarized from model output and compared to the Existing Conditions surface water flow.

4.1.1 Construction Phase

Changes to surface water flow during the construction phase will be limited to those associated with the development of the realignment features (channels and dams). The construction of these features will facilitate the lowering of water level in Côté Lake to develop the open pit and redirection of Bagsverd Creek for the TMF. However, the realignment features will be designed to manage the expected range of flows and as such, are not assessed separately from the potential effects that could arise from the operations phase.

4.1.2 Operations Phase

Predicted changes to surface water flows and levels during the operations phase in comparison to Existing Conditions are a result of several components that will alter watershed areas as well as the development of watercourse realignments, dam construction and on-site water management. Predicted changes to streamflows as a result of these developments are summarized below. The assessment considered the Project site at full development, and watershed areas under full operational conditions in comparison to baseline conditions. The assessment is summarized in Table 4-1.

Table 4-1: Operations Phase Estimated Watershed Areas

Watershed	Existing Conditions Area (ha)	Operations Phase Area (ha)
Mollie River (at Highway 144)	9,100	8,800
Mesomikenda Lake	64,000	62,100
Operational Footprint	n/a	2,200
Total	73,100	73,100

Note:
m³/day - cubic metres per day

The operations phase surface water schematic is presented in Figure 4-1 and the model was developed considering the Project footprint and on-site water management as outlined in Section 1.1.8. Operations phase simulations considered two alternatives for treated effluent discharge locations: the downstream end of Bagsverd Creek; and Mesomikenda Lake.

4.1.2.1 Model Output – Operations Phase

With the planned water management concepts (for on-site water management and realignments) incorporated into the water balance model, estimated change (%) from Existing Conditions in average annual surface water



flow are presented in Table 4-2 (for treated effluent discharge to Mesomikenda Lake) and Table 4-3 (for treated effluent discharge to Bagsverd Creek). Predicted magnitude change of annual average discharge estimates are provided in Attachment II. Changes in surface water flow were influenced primarily by two factors; i) the reconfiguration (addition or removal) of watershed area through the development of realignment channels, realignment dams and/or infrastructure footprints and/or ii) the connection of waterways to realignment channels that are now capable of conveying flows from a larger watershed area than the flows produced from the smaller area under Existing Conditions.

Table 4-2: Percent Change in Average Annual Surface Water Flow, Operations Phase, Treated Effluent Discharged to Mesomikenda Lake

Watershed	Location	Percent Change from Existing Conditions			Influence
		Wet Climate Conditions	Average Climate Conditions	Dry Climate Conditions	
		1:25-year		1:25-year	
Mesomikenda Lake	Mesomikenda Lake Outflow	-2%	-2%	-3%	Watershed reconfiguration
	Neville Lake Outflow	-6%	-6%	-7%	Watershed reconfiguration
	Somme River Outflow	0%	0%	0%	n/a
	Bagsverd Creek upstream of Effluent Discharge ¹	-19%	-20%	-21%	Watershed reconfiguration
	Un-named Lake #2 Outflow	>100%	>100%	>100%	Connection to realignment channel
	Bagsverd Lake Outflow	-14%	-13%	-16%	Watershed reconfiguration, connection to realignment channel ²
	Schist Lake Outflow	0%	0%	0%	n/a
	Little Clam Lake Outflow	>100%	>100%	>100%	Connection to realignment channel
Mollie River	Dividing Lake Outflow	-3%	-4%	-3%	Watershed reconfiguration
	Delaney Lake Outflow	0%	0%	0%	n/a
	Three Duck Lakes Outflow	-3%	-4%	-2%	Watershed reconfiguration



Watershed	Location	Percent Change from Existing Conditions			Influence
		Wet Climate Conditions	Average Climate Conditions	Dry Climate Conditions	
		1:25-year		1:25-year	
	Weeduck Outflow	>100%	>100%	>100%	Connection to realignment channel
	Côte Lake Outflow	n/a	n/a	n/a	n/a
	Clam Lake Outflow	>100%	>100%	>100%	Connection to realignment channel
	Chester Lake Outflow	-3%	-2%	-2%	Watershed reconfiguration, connection to realignment channel ²

Note:

m³/day = cubic metres per day

¹ No effluent discharge to Bagsverd Creek, Assessment Location identified for comparison to Existing Conditions

² Bagsverd Lake and Chester Lake watershed areas decrease, however outflows are directed to realignment channels which will be designed to accommodate these flow rates.

Table 4-3: Percent Change in Average Annual Surface Water Flow, Operations Phase, Treated Effluent Discharged to Bagsverd Creek

Watershed	Location	Percent Change from Existing Conditions			Influence
		Wet Climate Conditions	Average Climate Conditions	Dry Climate Conditions	
		1:25-year		1:25-year	
Mesomikenda Lake	Mesomikenda Lake Outflow	-2%	-2%	-3%	Watershed reconfiguration
	Neville Lake Outflow	-4%	-5%	-7%	Watershed reconfiguration
	Somme River Outflow	0%	0%	0%	n/a
	Effluent Discharge at Bagsverd Creek	-12%	-15%	-20%	Watershed reconfiguration
	Bagsverd Creek upstream of Effluent Discharge	-19%	-20%	-21%	Watershed reconfiguration



TECHNICAL SUPPORT DOCUMENT: HYDROLOGY

Watershed	Location	Percent Change from Existing Conditions			Influence
		Wet Climate Conditions	Average Climate Conditions	Dry Climate Conditions	
		1:25-year		1:25-year	
	Un-named Lake #2 Outflow	>100%	>100%	>100%	Connection to realignment channel
	Bagsverd Lake Outflow	-14%	-13%	-16%	Watershed reconfiguration, connection to realignment channel ¹
	Schist Lake Outflow	0%	0%	0%	n/a
	Little Clam Lake Outflow	>100%	>100%	>100%	Connection to realignment channel
Mollie River	Dividing Lake Outflow	-3%	-4%	-3%	Watershed reconfiguration
	Delaney Lake Outflow	0%	0%	0%	n/a
	Three Duck Lakes Outflow	-3%	-4%	-2%	Watershed reconfiguration
	Weeduck Outflow	>100%	>100%	>100%	Connection to realignment channel
	Côte Lake Outflow	n/a	n/a	n/a	n/a
	Clam Lake Outflow	>100%	>100%	>100%	Connection to realignment channel
	Chester Lake Outflow	-3%	-2%	-2%	Watershed reconfiguration, connection to realignment channel ¹

Note:

m³/day = cubic metres per day

¹Bagsverd Lake and Chester Lake watershed areas decrease, however outflows are directed to realignment channels which will be designed to accommodate these flow rates.

Predicted changes of greater than 10% to the average annual streamflow do not extend beyond the LSA, and total flow through the Mollie River and Mesomikenda Lake study watersheds will approximate Existing Conditions (<10% change in average annual discharge). The estimated water removed from Mesomikenda



Lake for process water demand (840 m³/day) comprise less than 1% of the average annual streamflow at the Mesomikenda Lake outflow.

For each climate condition, the largest increases in annual average discharge (>100% change) were predicted for lakes and streamwater bodies that were previously headwater lakes (i.e. Little Clam Lake, Clam Lake, Weeduck Lake and Un-named Lake #2) and have now been incorporated into the realigned surface water system. The realigned surface water system has been designed to accommodate the predicted range of flows and as such, these flows increases are not considered an environmental concern. Similarly, the predicted decrease in flow at the Bagsverd Lake outflow (-13% to -16%) was not considered an environmental concern, where flow from the lake will be directed to a realignment channel rather than Bagsverd Creek.

In Bagsverd Creek, the change in the upstream watershed area (due to TMF development and realignment features) was predicted to decrease average annual flow by up to 21% during dry climate conditions (with treated effluent directed to Mesomikenda Lake). With treated effluent directed to Bagsverd Creek, discharge was decreased by a similar magnitude upstream of the planned discharge location (up to 21% in dry climate conditions); however contributions from the treated effluent diminished the overall decrease in discharge at the outlet of Bagsverd Creek under wet and average climate conditions (-12% and- 15%, respectively).

Decreases in discharge (and corresponding water level) in Bagsverd Creek will need to be considered in the context of in-stream characteristics (such as sedimentation/erosional processes and connection to downstream features). Currently these in-stream characteristics of the creek are also likely influenced by transient beaver activity (Attachment I). Given the observed range in discharge and water level (Attachment I); and the general stream characteristics (low-gradient, bordered by wetland), these flow decreases (-15 to -20%) were qualitatively considered unlikely to alter in-stream characteristics such as sedimentation, or connection to downstream waterways beyond the existing variation in observed conditions. The development of a monitoring plan for Bagsverd Creek is outlined in Section 5.2.

4.1.3 Post-Closure Phase Stage I

At post-closure stage I (the pit flooding stage), realignment features remain in place and water level in the Côté open pit will rise in response to precipitation inputs, runoff, groundwater inflow and active pumping of the MRA collection ponds. Overflow from the open pit should not occur during this stage. With the cessation of ore processing, runoff from the footprint of the TMF will be passively discharged to Mesomikenda Lake, while water accumulated in the polishing pond will be passively discharged to Bagsverd Creek (Figure 4-2).

4.1.3.1 Model Output – Post-Closure Phase Stage I

With the incorporation of the planned water management concepts (for on-site water management and realignments) incorporated into the water balance model, estimated change (%) from Existing Conditions in average annual surface water flow are presented in Table 4-4. Predicted magnitude change of annual average discharge estimates are provided in Attachment II.

Table 4-4: Percent Change in Average Annual Surface Water Flow, Post-Closure Phase Stage I

Watershed	Location	Percent Change from Existing Conditions	Influence
-----------	----------	---	-----------



TECHNICAL SUPPORT DOCUMENT: HYDROLOGY

		Wet Climate Conditions	Average Climate Conditions	Dry Climate Conditions	
		1:25-year		1:25-year	
Mesomikenda Lake	Mesomikenda Lake Outflow	-1%	-1%	-1%	Watershed reconfiguration
	Neville Lake Outflow	-6%	-6%	-7%	Watershed reconfiguration
	Somme River Outflow	0%	0%	0%	n/a
	Bagsverd Creek upstream of Effluent Discharge ¹	-18%	-19%	-19%	Watershed reconfiguration
	Un-named Lake #2 Outflow	>100%	>100%	>100%	Connection to realignment channel
	Bagsverd Lake Outflow	-14%	-13%	-16%	Watershed reconfiguration, connection to realignment channel ²
	Schist Lake Outflow	0%	0%	0%	n/a
	Little Clam Lake Outflow	>100%	>100%	>100%	Connection to realignment channel
Mollie River	Dividing Lake Outflow	-3%	-4%	-3%	Watershed reconfiguration
	Delaney Lake Outflow	0%	0%	0%	n/a
	Three Duck Lakes Outflow	-3%	-4%	-2%	Watershed reconfiguration
	Weeduck Outflow	>100%	>100%	>100%	Connection to realignment channel
	Côté Lake Outflow	n/a	n/a	n/a	n/a
	Clam Lake Outflow	>100%	>100%	>100%	Connection to realignment channel
	Chester Lake Outflow	-3%	-2%	-2%	Watershed reconfiguration, connection to realignment



Watershed	Location	Percent Change from Existing Conditions			Influence
		Wet Climate Conditions	Average Climate Conditions	Dry Climate Conditions	
		1:25-year		1:25-year	
					channel ²

Note:

m³/day = cubic metres per day

¹ No effluent discharge to Bagsverd Creek, Assessment Location identified for comparison to Existing Conditions

² Bagsverd Lake and Chester Lake watershed areas decrease, however outflows are directed to realignment channels which will be designed to accommodate these flow rates.

In general, changes to surface water flow for post closure phase stage I were predicted to be similar to the operations phase, a result of the realignment features remaining in place and active management of the MRA collection ponds to flood the open pit.

For each climate condition, the largest increases in annual average discharge (>100% change) were predicted for water bodies that were previously headwater lakes (i.e. Little Clam Lake, Clam Lake, Weeduck Lake and Un-named Lake #2) and remain incorporated into the realigned surface water system. The realigned surface water system has been designed to accommodate the predicted range of flows, and as such these flow increases are not considered an environmental concern. Similarly, the predicted decrease in flow at the Bagsverd Lake outflow (-13% to -16%) was not considered an environmental concern as flow from the lake will be directed to a realignment channel rather than Bagsverd Creek.

At the Bagsverd Creek assessment point, a reconnection of the polishing pond also contributed flow to the creek, and average annual flow decreased by up to 19% (in dry climate conditions).

As with Operations, the predicted decreases in flow in Bagsverd Creek will need to be considered in the context of in-stream characteristics (such as sedimentation/erosional processes and connection to downstream features). Currently these in-stream characteristics of the creek are also likely influenced by transient beaver activity (Attachment I). Given the observed range in discharge and water level (Attachment I); and the general stream characteristics (low-gradient, bordered by wetland), these flow decreases (-18% to -19%) were qualitatively considered unlikely to alter in-stream characteristics such as sedimentation, or connection to downstream waterways beyond the existing variation in observed conditions. The development of a monitoring plan for Bagsverd Creek is outlined in Section 5.2.

4.1.4 Post-Closure Phase Stage II

In post-closure phase stage II, water level will have recovered in Côté Pit to an elevation sufficient to cause overflow (and reconnection) of the Pit Lake to the upper basin of Three Duck Lakes. With acceptable water quality, the MRSPs will overflow to local surface water bodies. The reconfiguration of the realignment features will result in watersheds that more closely resemble those of existing conditions. As displayed in Figure 4-3, some Lakes will be disconnected from realignments but will maintain their realignment outflow features (e.g.



Weeduck Lake), others will remain connected to watershed realignments (e.g., Bagsverd Lake, Chester Lake), or will essentially merge with other lakes (Little Clam Lake and Clam Lake).

4.1.4.1 Model Output – Post-Closure Phase Stage II

With runoff from the MRA directed to local receivers and alterations to realignment features incorporated into the water balance model, estimated change (%) from Existing Conditions in average annual surface water flow are presented in Table 4-5. Predicted magnitude change of annual average discharge estimates are provided in Attachment II.

Table 4-5: Percent Change, Average Annual Surface Water Flow, Post-Closure Phase Stage II

Watershed	Location	Percent Change from Existing Conditions			Influence
		Wet Climate Conditions	Average Climate Conditions	Dry Climate Conditions	
		1:25-year		1:25-year	
Mesomikenda Lake	Mesomikenda Lake Outflow	0%	0%	0%	n/a
	Neville Lake Outflow	-4%	-4%	-5%	Watershed reconfiguration
	Somme River Outflow	0%	0%	0%	n/a
	Bagsverd Creek upstream of Effluent Discharge ¹	-12%	-13%	-13%	Watershed reconfiguration
	Un-named Lake #2 Outflow	>100%	>100%	>100%	Connection to realignment channel
	Bagsverd Lake Outflow	-1%	-2%	-3%	Watershed reconfiguration, connection to realignment channel ²
	Schist Lake Outflow	0%	0%	0%	n/a
Mollie River	Dividing Lake Outflow	4%	2%	2%	Watershed reconfiguration
	Delaney Lake Outflow	1%	1%	1%	Watershed reconfiguration
	Three Duck Lakes Outflow	8%	5%	4%	Watershed reconfiguration



Watershed	Location	Percent Change from Existing Conditions			Influence
		Wet Climate Conditions	Average Climate Conditions	Dry Climate Conditions	
		1:25-year		1:25-year	
	Weeduck Outflow	52%	22%	34%	Watershed reconfiguration, connection to realignment channel ²
	Côté Lake Outflow	5%	1%	0%	Watershed reconfiguration, connection to realignment channel ²
	Clam Lake Outflow ³	>100%	>100%	>100%	Watershed reconfiguration, connection to realignment channel ²
	Chester Lake Outflow	2%	2%	2%	Watershed reconfiguration, connection to realignment channel ²

Note:

m³/day = cubic metres per day

¹ No effluent discharge to Bagsverd Creek, Assessment Location identified for comparison to Existing Conditions

² Bagsverd Lake, Weeduck Lake, Côté Lake, Clam Lake and Chester Lake watershed areas change from Existing Conditions, however outflows are directed to realignment channels which will be designed to accommodate these flow rates.

³ Clam Lake and Little Clam Lake will have the same elevation and will outflow to Côté Lake.

Where realignments remain, flows were predicted to continue to be increased relative to Existing Conditions in lakes that were originally headwater lakes (such as Un-named Lake #2 and Clam Lake). Weeduck Lake will be disconnected from upstream realignments but will increase in watershed area relative to Existing Conditions and will maintain a channel outflow, resulting in flow increases of at least 22% (though the absolute magnitude change is minimal; Attachment II). Surface water flows through the remainder of the system will approximate Existing Condition flows (<10% change), with the exception of Bagsverd Creek which was simulated to have a decrease in flow (up to -13%) primarily as a result of the loss of contributing area (the TMF footprint), which will continue to discharge via gravity to Mesomikenda Lake.

As with the operations phase and post closure phase stage I, the predicted decreases in flow in Bagsverd Creek will need to be considered in the context of in-stream characteristics (such as sedimentation/erosional processes and connection to downstream features). Currently these in-stream characteristics of the creek are also likely influenced by transient beaver activity (Attachment I). Given the observed range in discharge and water level (Attachment I); and the general stream characteristics (low-gradient, bordered by wetland), these flow decreases



(-12% to -13%) were qualitatively considered as unlikely to alter in-stream characteristics such as sedimentation, or connection to downstream waterways beyond the existing variation in observed conditions. Monitoring is proposed on Bagsverd Creek and is described in Section 5.2.

4.2 Other Predicted Effects

While not considered as an environmental assessment indicator, an estimate of the time to flood the Côté open pit was completed. This provided an approximate timeline for the period between the post-closure phase stage I and stage II. The assessment considered runoff to, and precipitation on, the open pit as well as groundwater inflow and active pumping of the MRA collection ponds as inflows, and evaporation as water loss from the flooding pit. With these water budget components considered, the open pit will flood in approximately 50 to 80 years.

5.0 MITIGATION AND MONITORING

5.1 Mitigation

The prediction of water quality effects was completed based on several inherent mitigation measures that have been included in the design of the Project. These include:

- Engineered facilities will be constructed to store mine rock (MRA), ore at the low-grade stockpile and tailings (TMF).
- Engineered water management systems will be constructed to collect runoff and seepage from the MRA, low-grade stockpile, TMF, and polishing pond during the operations phase and post-closure phase stage I.
- Engineered realignment channels will be constructed to convey the range of flows that can be reasonably expected over the projected life of mine or life of realignment feature as applicable.
- Contact water comprised of inflows and runoff from the pit walls, runoff and seepage from the MRA and low-grade stockpile, and runoff from the processing plant will be collected and pumped to the mine water pond during the operations phase and pumped to the open pit during the post-closure phase stage I. Contact and process water contained within the TDSPs and polishing pond collection ponds will be pumped back into the reclaim pond and polishing pond (respectively) during the operations phase.
- A low-permeable liner will be installed at the mine water pond.
- Erosion and sediment control measures will be constructed to promote settling of sediments and mitigate the migration of suspended solids into nearby surface water features.

5.2 Monitoring

Considering the potential effects of the Project on the hydrological EAI (surface water flow), a hydrological monitoring program has been developed and is outlined below. This program is to be incorporated into an overall



water monitoring program for the Project and will include the continued monitoring of streamflow and water level at key surface water locations across the Project site.

The hydrological monitoring program is to be integrated with the monitoring programs developed for the hydrogeology, water quality, aquatic biology and terrestrial ecology disciplines and documented within their respective TSDs. The result of the hydrological monitoring program will be integrated with the results obtained from the other disciplines on an annual basis, and the results will be assessed in consideration of ongoing operational activities. As such, these annual reports will also consider revision to the location and frequency of hydrological monitoring as appropriate.

5.2.1 Hydrological Monitoring

Measurement of streamflow and water level will continue at selected existing locations (installed in 2012 and 2013) and new locations as necessary in the waterways around the infrastructure footprint. Existing locations may require upgrades for long-term monitoring. The location of the new monitoring stations may be aligned with groundwater monitoring to monitor interactions between groundwater and surface water, and will also consider the realigned channels.

Hydrological stations will be monitored for streamflow quarterly to capture seasonal variability and will be equipped with dataloggers to monitor water level on a half-hour interval. It is assumed that Environment Canada will maintain the streamflow gauging station on the Mollie River and OPG will maintain records of discharge and water level at the Mesomikenda Lake Dam. Available information from these databases will be referenced and compiled along with operational data such as monitoring of on-site water removals, discharge, transfer pumping and reservoir water levels and presented in an annual monitoring report.

5.2.2 Meteorological Monitoring

The collection of meteorological monitoring at the Project site will continue with the use of the installed meteorological tower. The station will be downloaded quarterly and checked for data consistency and comparison with regional climate monitoring stations and previously established spatial trends.

5.2.3 In-Stream Characteristics – Bagsverd Creek

The predicted changes in streamflow are not anticipated to affect the in-stream characteristics of Bagsverd Creek. However, a supporting monitoring program focussed on the reach of Bagsverd Creek downstream of Un-named Lake #1 is recommended. The monitoring program should be completed twice annually, following snowmelt and at low flow conditions, and will be initiated prior to realignment development to establish Existing Conditions. The monitoring should include:

- TSS sampling for suspended solids concentrations;
- stream cross-sections at several locations for channel geometry;
- installation of erosion pins in stream banks and disturbance rods in the streambed to assess sedimentation and erosion; and



- aerial or photographic analysis to assess stream meander.

This in-stream study can also be applied to the realignment channels in order to monitor hydrological function and compare physical stream characteristics to the design intent.

6.0 CONCLUSIONS

Based upon the results of the studies and effects assessment completed, the following conclusions are presented for the hydrogeological environment:

- 1) The Côte Gold project will affect the hydrological environment principally through the: construction of realignment features, excavation of an open pit mine, and the development of the MRA and TMF.
- 2) Surface water flow has been identified as an effects assessment indicator. Changes in surface water flow, as may result from Project activities, could affect the in-stream characteristics of the waterway (through erosional or sedimentation processes).
- 3) The area has been investigated through the installation of 14 streamflow monitoring locations and an on-site meteorological tower as well as bathymetric surveys. These field studies have been intended to characterize the local climate and the response of the hydrological system to a range of climatological conditions.
- 4) The Project site is located in close proximity to the Great Lakes / James Bay watershed divide. As such the hydrological system has limited upstream inflows and forms the headwaters of the Mattagami River.
- 5) The Project site can be divided into two watersheds. These are i) the Mollie River watershed, which flows north through Côte Lake, south through Three Duck Lakes and eastward via the Mollie River to Minisinakwa Lake and ii) the Mesomikenda Lake watershed, which drains northward from Bagsverd Lake and eastward from the Somme River prior to confluence at Neville Lake and discharge to Mesomikenda Lake. The Mesomikenda Lake outflow is directed to the Makani River and Minisinakwa Lake.
- 6) The hydrological regime of watercourses at the Project site is characterized by a wide range of observed discharge values (up to three orders of magnitude) between monitored sites.
- 7) A hydrological model was developed to estimate the existing condition surface water system and subsequently to compare surface water flow during the operations and post-closure phases. The model was based on the available background data and mine water management concepts.
- 8) During Operations, surface water flow changes of greater than 10% can be expected where watershed areas are influenced through planned realignments or infrastructure development. The changes are limited to within the LSA and the highest change was simulated to occur where realignment plans exist. Flow decrease in Bagsverd Creek (up to -21%) was estimated as a result of watershed loss to realignment and TMF development.
- 9) During post-closure phase stage I, surface water flow will remain similar to operations, as water is managed similarly in this stage and the operations phase. Slight increases to flow to Bagsverd Creek will occur as the polishing pond watershed is reconnected.



- 10) The time to flood the open pit to the original Côté Lake water level, and therefore the time lapsed between post-closure phase stage I and post-closure phase stage II will be approximately 50 to 80 years, assuming active management of the MRA collection ponds continues.
- 11) During post-closure phase stage II, waterways will be reconnected similarly to the existing conditions. Lakes that remain connected to realignment features in this stage displayed higher daily average streamflow than during existing conditions, and streamflow was decreased in Bagsverd Creek, where the TMF watershed area was directed to Mesomikenda Lake. However, total streamflow change through the Mollie River and Mesomikenda Lake watersheds was less than 5%.

7.0 REFERENCES

- Environment Canada. 2013. Government of Canada – Climate. Available online at http://climate.weather.gc.ca/index_e.html. Accessed October 2013.
- Mattagami Region Source Protection Committee. 2012. Proposed Source Protection Plan for the Mattagami Region Source Protection Area.
- Ontario Ministry of Natural Resources. 1984. Water Quantity Resources of Ontario. MNR PUB 5932.
- Ontario Ministry of Natural Resources. 2006. Tembec Industries, Beaver Power Corporation and Ontario Power Generation Inc. 2006. Mattagami River Water Management Plan.



Report Signature Page

GOLDER ASSOCIATES LTD.

Stephen Kautman, M.Sc.
Hydrologist



John Petrie, P. Geo.
Principal/Hydrogeologist

KAB/SK/JMP/ljs

Golder, Golder Associates and the GA globe design are trademarks of Golder Associates Corporation.

\\sud1-s-netapp01\data\data\active\2013\1190 sudbury\1192\13-1192-0021 iamgold cote gold project timmins\2. hydrology and climate\reporting\tsd\13-1192-0021r2 rpt 14nov7 revised iamgold hydrology tsd.docx

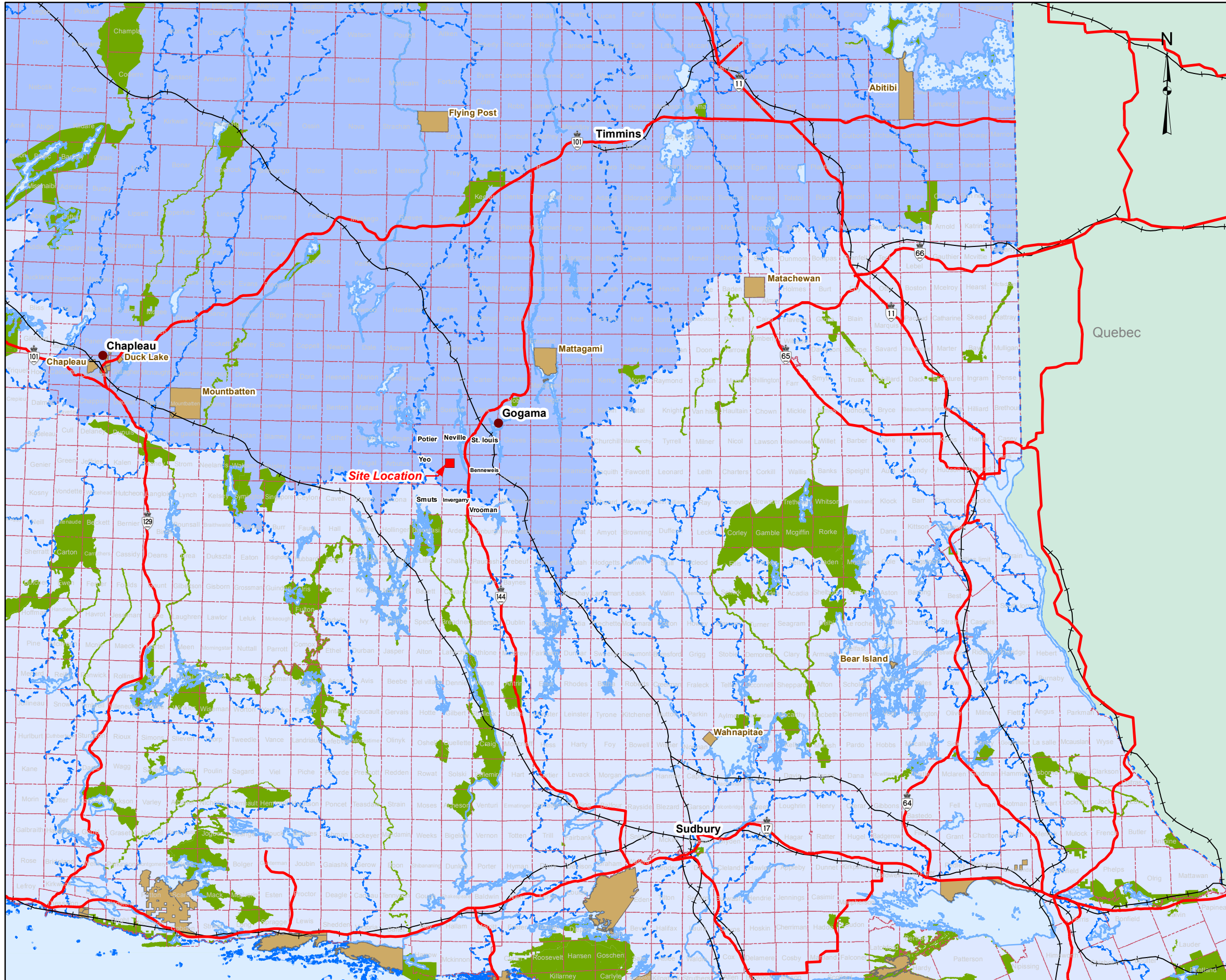
Path: Z:\Projects\2013113-1192-0021\GIS\MXDs\Reporting\Hydrology\TSD\Figure1-1_Project_Location.mxd



LEGEND

- Populated Places
- Major Roads
- Railway
- First Nations Communities
- Townships
- Provincial Park
- Primary Watersheds**
- Hudson Bay
- Great Lakes

REFERENCE

Base Data - MNR NRVIS, CANMAP v2008.4
 Produced by Golder Associates Ltd under licence from
 Ontario Ministry of Natural Resources, © Queens Printer 2012
 Projection: Transverse Mercator Datum: NAD 83 Coordinate System: UTM Zone 17

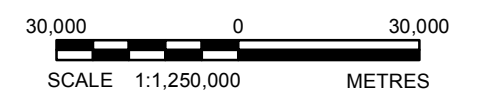

PROJECT		IAMGOLD CÔTÉ GOLD PROJECT	
TITLE		Project Location	
Golder Associates Sudbury, Ontario	PROJECT No.	13-1192-0021	SCALE AS SHOWN
	DESIGN	RRD Dec 2012	REV. 0
	GIS	RRD Oct 2013	FIGURE: 1-1
	CHECK	MO Jan 2014	
REVIEW	JMP Jan 2014		

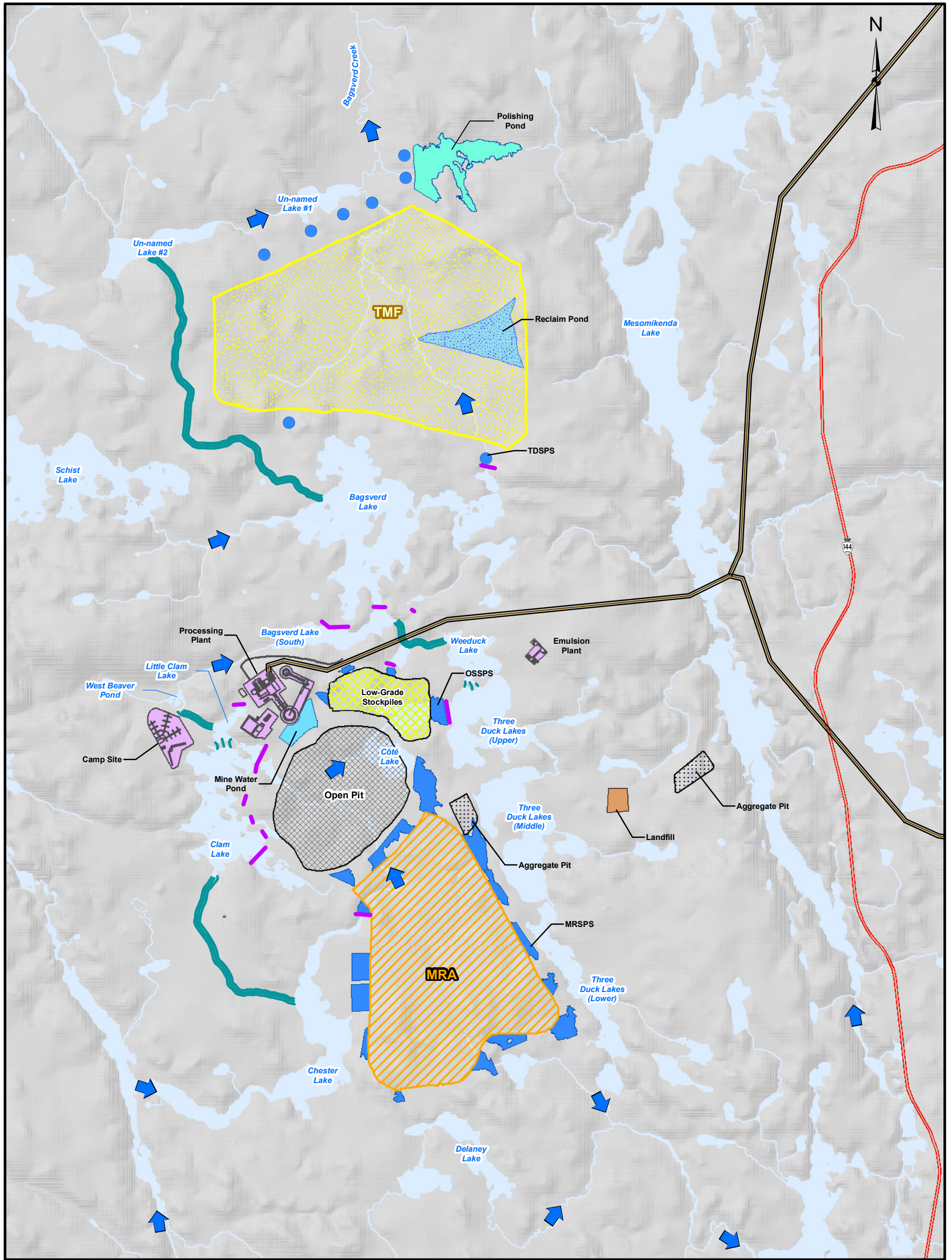

LEGEND

- Highway 144
- Realignment Dams
- Transmission Line
- Watercourse Realignment
- Low-Grade Stockpiles
- Mine Rock Area (MRA)
- Tailings Management Facility (TMF)
- Open Pit
- Polishing Pond
- Reclaim Pond
- Aggregate Pit
- Facilities
- Mine Water Pond
- Landfill
- Collection Ponds
- Waterbodies
- Creek / River
- Surface Water Flow Direction

REFERENCE

Open Pit Shell provided by IAMGOLD, May 2013
 Base Data - MNR NRVIS, CANMAP v2008.4
 Produced by Golder Associates Ltd under licence from Ontario Ministry of Natural Resources,
 © Queens Printer 2013
 Projection: Transverse Mercator Datum: NAD 83 Coordinate System: UTM Zone 17

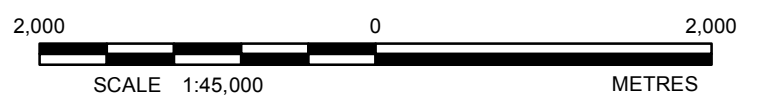

PROJECT		IAMGOLD CÔTÉ GOLD PROJECT	
TITLE		Site Plan	
PROJECT No. 13-1192-0021		SCALE AS SHOWN	REV. 0
DESIGN	RRD	Feb. 2013	FIGURE: 1-2
GIS	AL	Jan. 2014	
CHECK	SK	Jan. 2014	
REVIEW	JMP	Nov. 2013	



Path: Z:\Projects\2013113-1192-0021\GIS\MXDs\Reporting\Hydrology\TSD\Fig_2-1_LSA.mxd

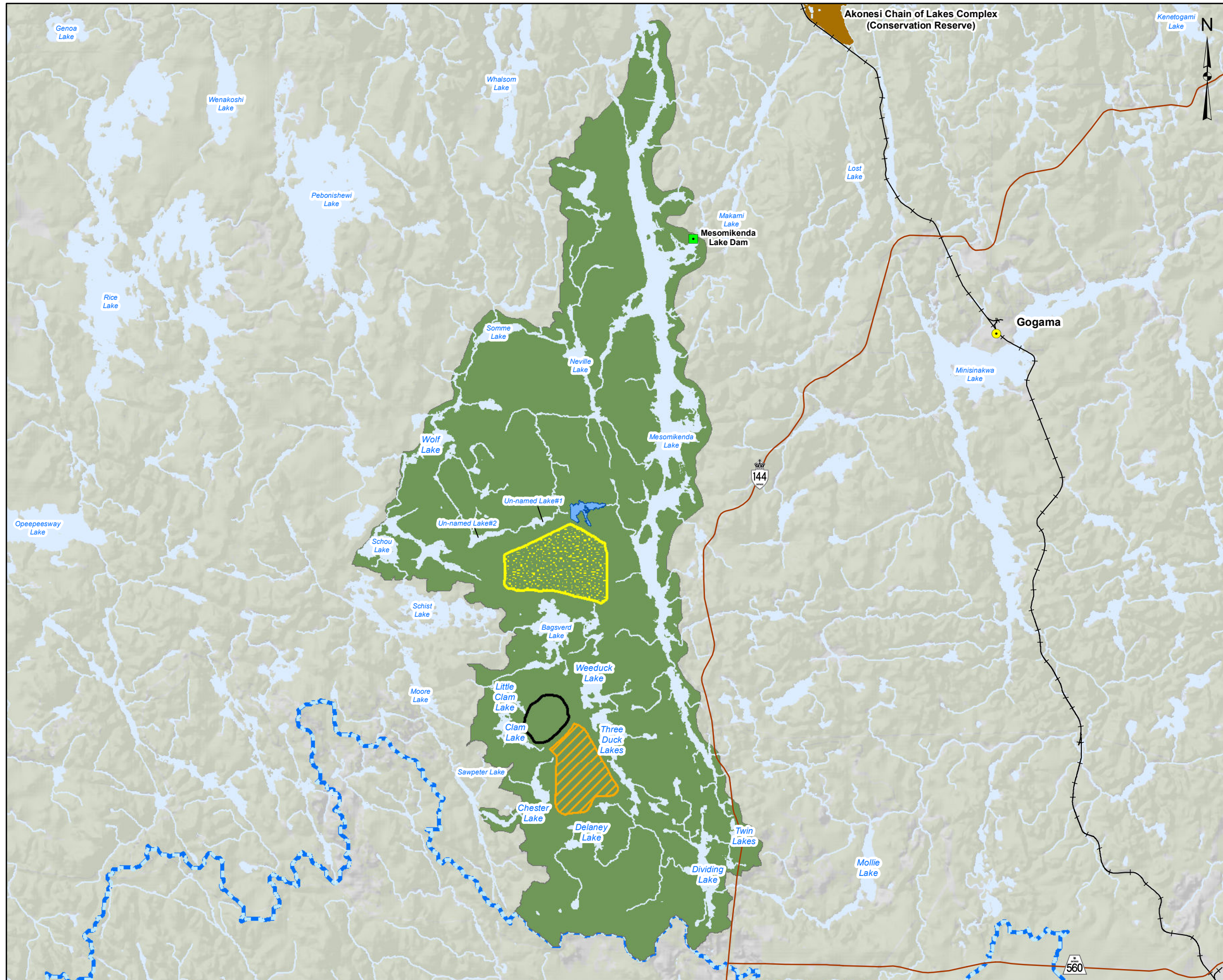



LEGEND

- Dams
- Major Roads
- +— Railway
- Mine Rock Area (MRA)
- Polishing Pond
- Tailings Management Facility (TMF)
- Open Pit
- Waterbody/ Large Watercourse
- Conservation Reserve (Regulated)
- Rivers
- Hydrology Local Study Area
- Great Lakes / James Bay Watershed Divide

REFERENCE

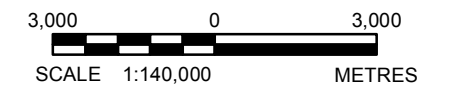
IAMGOLD Open Pit, May 2013.
 Base Data - MNR NRVIS, CANMAP v2008.4
 Produced by Golder Associates Ltd under licence from
 Ontario Ministry of Natural Resources, © Queens Printer 2012
 Projection: Transverse Mercator Datum: NAD 83 Coordinate System: UTM Zone 17



PROJECT		IAMGOLD CÔTÉ GOLD PROJECT	
TITLE		Hydrology Local Study Area	
	PROJECT No.	13-1192-0021	SCALE AS SHOWN
	DESIGN	RRD Dec. 2012	REV. 0
	GIS	RRD Jan. 2014	FIGURE: 2-1
	CHECK	SK Jan. 2014	
REVIEW	JMP Jan. 2014		

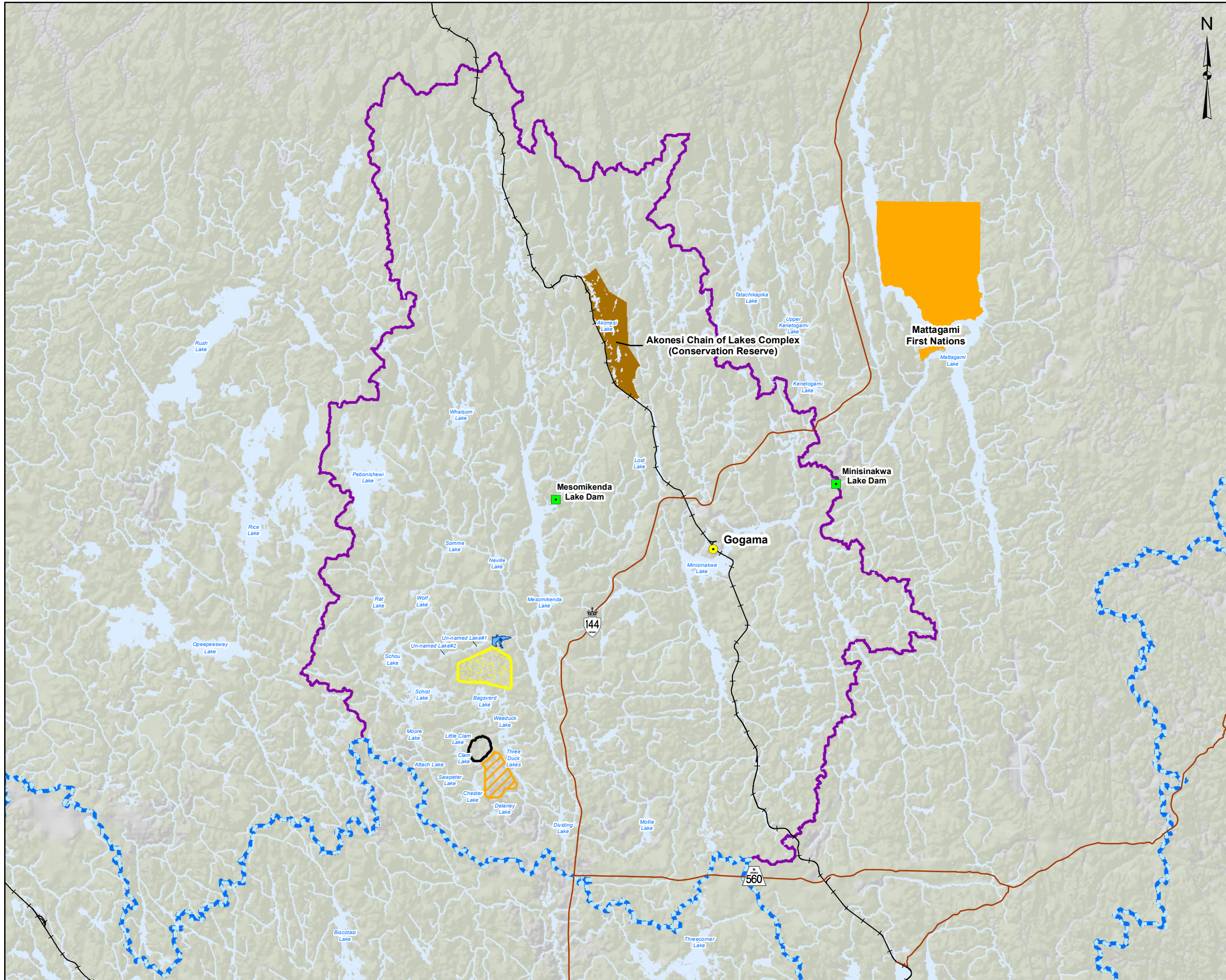

LEGEND

- Dams
- Major Roads
- Railway
- First Nation Reserve
- Mine Rock Area (MRA)
- Polishing Pond
- Tailings Management Facility (TMF)
- Open Pit
- Waterbody / Large Watercourse
- Conservation Reserve (Regulated)
- Rivers
- Great Lakes/ James Bay Watershed Divide
- Hydrology Regional Study Area

REFERENCE

IAMGOLD Open Pit, May 2013.
 Base Data - MNR NRVIS, CANMAP v2008.4
 Produced by Golder Associates Ltd under licence from
 Ontario Ministry of Natural Resources, © Queens Printer 2012
 Projection: Transverse Mercator Datum: NAD 83 Coordinate System: UTM Zone 17

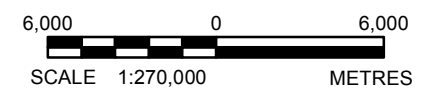

PROJECT		CÔTÉ GOLD PROJECT	
TITLE		Hydrology Regional Study Area	
 Golder Associates Sudbury, Ontario	PROJECT No. 13-1192-0021	SCALE AS SHOWN	REV. 0
	DESIGN RRD Dec. 2012	FIGURE: 2-2	
	GIS RRD Jan. 2014		
	CHECK SK Jan. 2014		
REVIEW JMP Jan. 2014			

Path: Z:\Projects\2013113-1192-0021\GIS\MXDs\Reporting\Hydrology\TSD\Figure_2-3_Hydrological_Monitoring_South.mxd

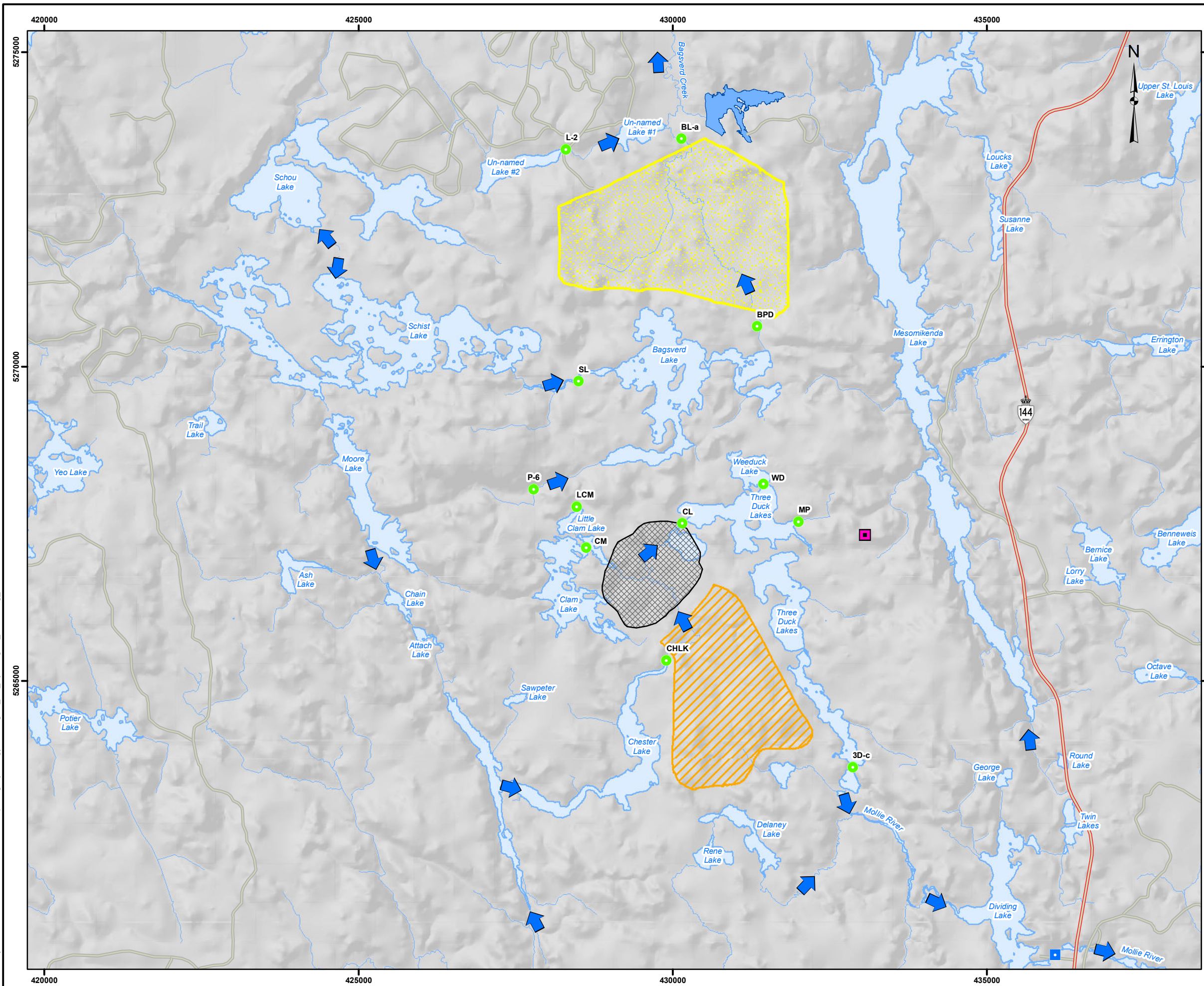

LEGEND

- Automatic Water Level & Manual Water Flow (Monthly)
- Meteorological Station
- Regional Hydrological Monitoring Location
- Major Road
- Open Pit
- Polishing Pond
- Tailings Management Facility (TMF)
- Mine Rock Area (MRA)
- Rivers
- Waterbodies

REFERENCE

Open Pit Shell provided by IAMGOLD, May 2013
 Base Data - MNR NRVIS, CANMAP v2008.4
 Produced by Golder Associates Ltd under licence from
 Ontario Ministry of Natural Resources, © Queens Printer 2013
 Projection: Transverse Mercator Datum: NAD 83 Coordinate System: UTM Zone 17



PROJECT		IAMGOLD CÔTÉ GOLD PROJECT																					
TITLE		Local Hydrological Monitoring Locations (Southern Portion)																					
	Golder Associates Sudbury, Ontario	<table border="1" style="width: 100%; border-collapse: collapse;"> <tr> <td>PROJECT No.</td> <td>13-1192-0021</td> <td>SCALE AS SHOWN</td> <td>REV. 0</td> </tr> <tr> <td>DESIGN</td> <td>RRD Dec. 2012</td> <td colspan="2"></td> </tr> <tr> <td>GIS</td> <td>AL Oct. 2013</td> <td colspan="2"></td> </tr> <tr> <td>CHECK</td> <td>SK Jan. 2014</td> <td colspan="2"></td> </tr> <tr> <td>REVIEW</td> <td>KAB Jan. 2014</td> <td colspan="2"></td> </tr> </table>	PROJECT No.	13-1192-0021	SCALE AS SHOWN	REV. 0	DESIGN	RRD Dec. 2012			GIS	AL Oct. 2013			CHECK	SK Jan. 2014			REVIEW	KAB Jan. 2014			FIGURE: 2-3
PROJECT No.	13-1192-0021	SCALE AS SHOWN	REV. 0																				
DESIGN	RRD Dec. 2012																						
GIS	AL Oct. 2013																						
CHECK	SK Jan. 2014																						
REVIEW	KAB Jan. 2014																						

Path: Z:\Projects\2013\13-1192-0021\GIS\MXDs\Reporting\Hydrology\TSD\Figure_2-4_Hydrological_Monitoring_North.mxd

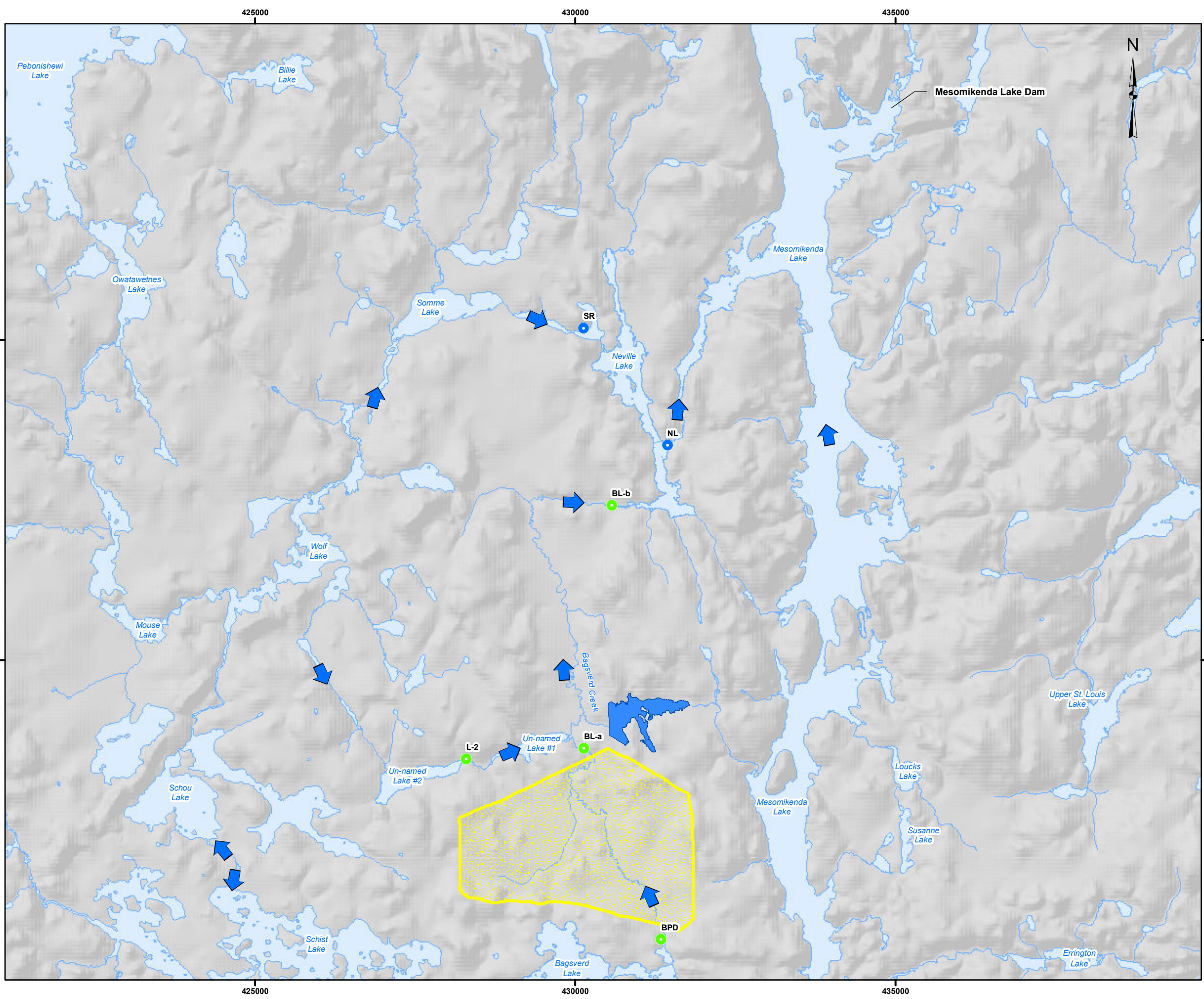

LEGEND

- Automatic Water Level & Manual Water Flow (Monthly)
- Automatic Water Level & Manual Water Flow (Quarterly)
- Meteorological Station
- ▬ Polishing Pond
- Tailings Management Facility (TMF)
- Rivers
- ▭ Waterbodies

*NOTE: Neville Lake (NL) monitoring Station installed Fall 2013

REFERENCE

Open Pit Shell provided by IAMGOLD, May 2013
 Base Data - MNR NRVIS, CANMAP v2008.4
 Produced by Golder Associates Ltd under licence from
 Ontario Ministry of Natural Resources, © Queens Printer 2013
 Projection: Transverse Mercator Datum: NAD 83 Coordinate System: UTM Zone 17



PROJECT		CÔTÉ GOLD PROJECT	
TITLE		Local Hydrological Monitoring Locations (Northern Portion)	
	PROJECT No. 13-1192-0021	SCALE AS SHOWN	REV. 1
DESIGN	RRD	Dec. 2012	FIGURE: 2-4
GIS	AL	Jan. 2014	
CHECK	SK	Jan. 2014	
REVIEW	KAB	Jan. 2014	

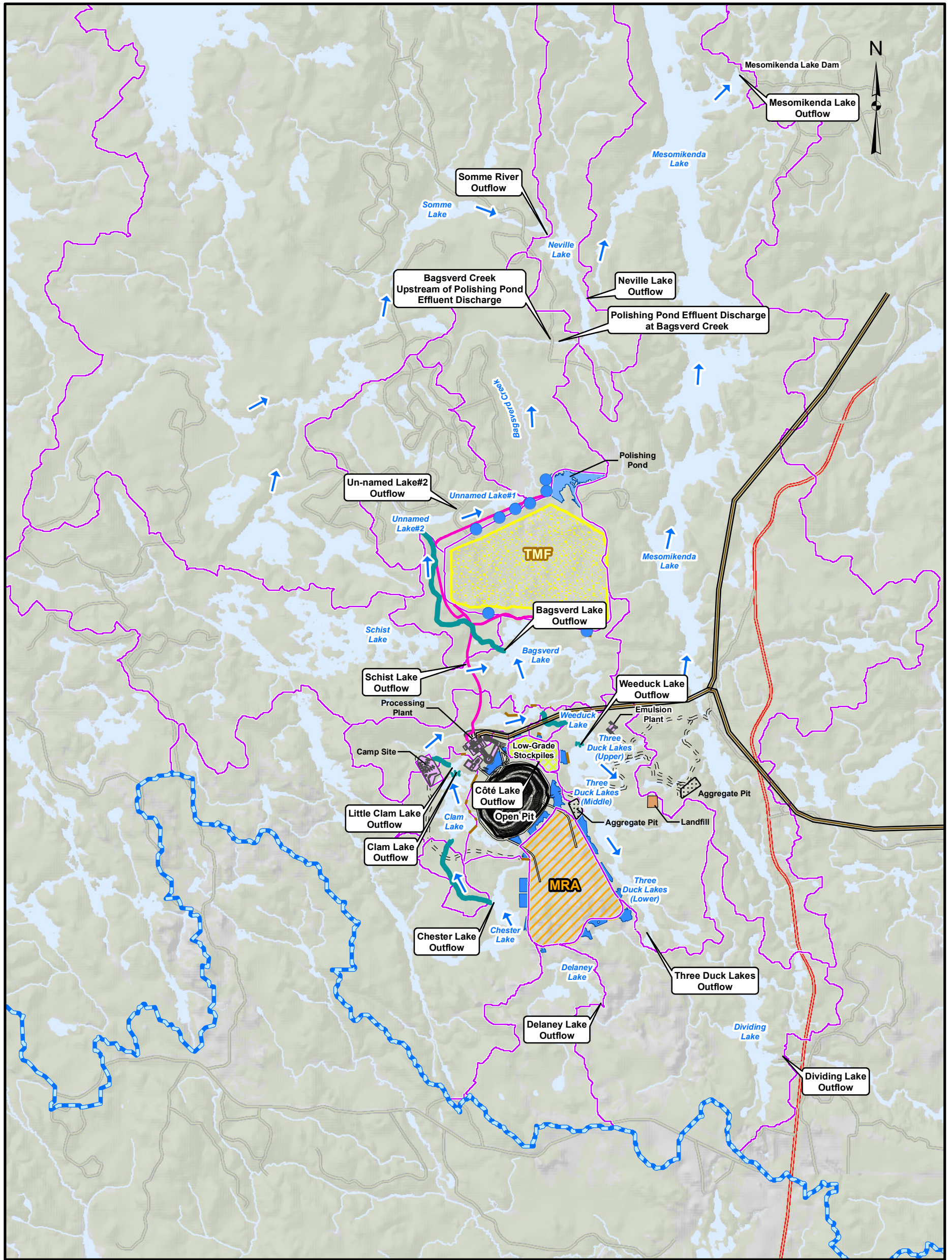

LEGEND

- Transmission Line
- Watercourse Realignment
- Tailings and Reclaim Pipeline
- Realignment Dams
- Aggregate Pit
- Landfill
- Facilities
- Great Lakes / James Bay Watershed Divide
- Infrastructure Watersheds
- Pit Limit
- Polishing Pond
- Ore Stockpile
- Tailings Management Facility (TMF)
- Mine Rock Area (MRA)
- Regional Roads
- Highway 144
- Site Access Roads
- Pit Roads
- Collection Ponds
- Waterbodies
- Creek/River
- Wooded Areas
- Surface Water Flow Direction

REFERENCE

IAMGOLD Open Pit, May 2013.
 Base Data - MNR NRVIS, CANMAP v2008.4
 Produced by Golder Associates Ltd under licence from Ontario Ministry of Natural Resources,
 © Queens Printer 2013
 Projection: Transverse Mercator Datum: NAD 83 Coordinate System: UTM Zone 17

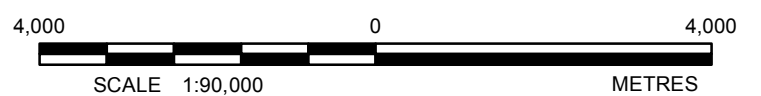

PROJECT		IAMGOLD CÔTÉ GOLD PROJECT	
TITLE			
Effects Assessment Locations			
PROJECT No. 13-1192-0021		SCALE AS SHOWN	REV. 0
DESIGN	RRD	Feb. 2013	FIGURE: 2-5
GIS	RRD	Jan. 2014	
CHECK	SK	Jan. 2014	
REVIEW	JMP	Jan. 2014	



INFLOW FROM SCHOU, PEBONISHEWI,
BILLIE, OWATAWETNES, MOUSE, WOLF,
VIVIAN, WHALSOM AND SOMME LAKES

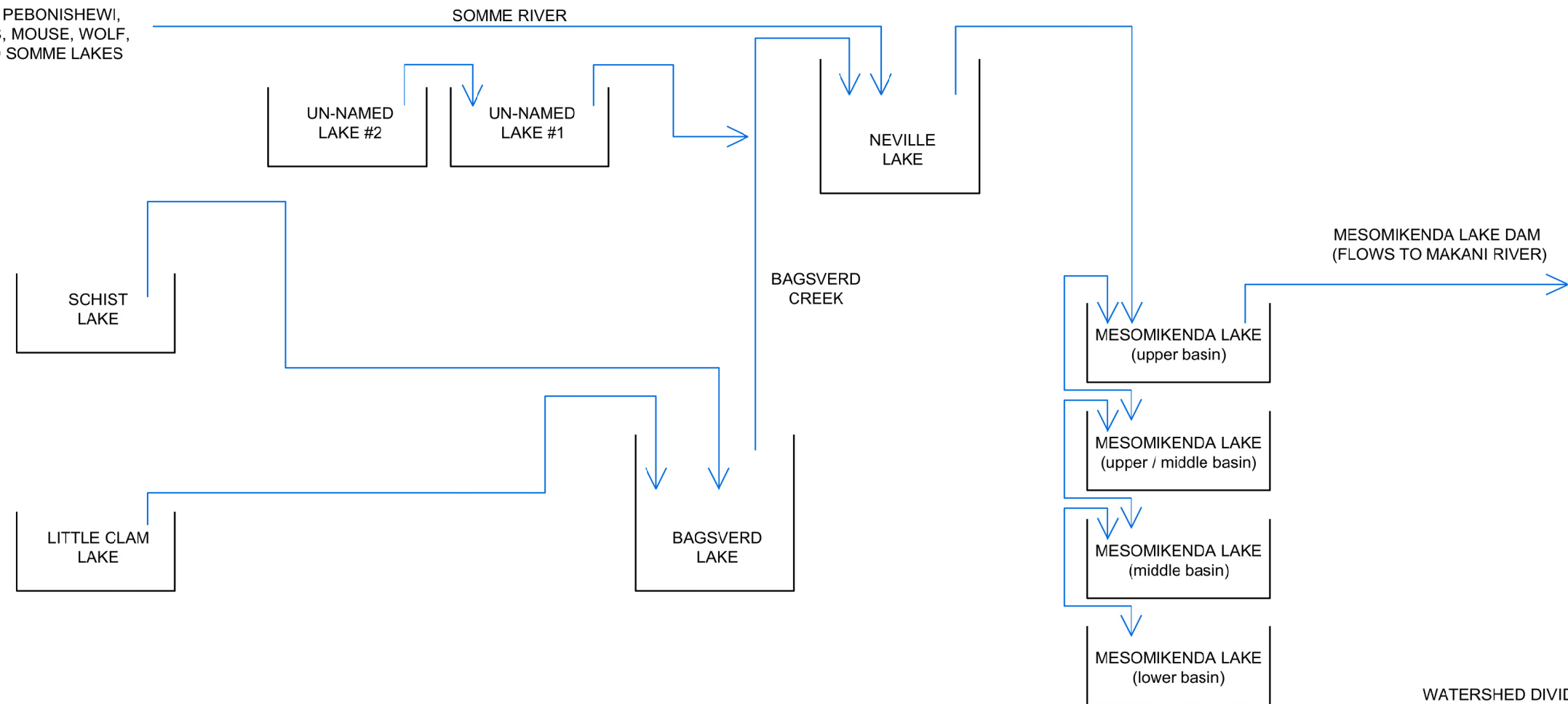

WATERSHED DIVIDE

INFLOW FROM ASH, MOORE, CHAIN,
ATTACH AND SAWPETER LAKES

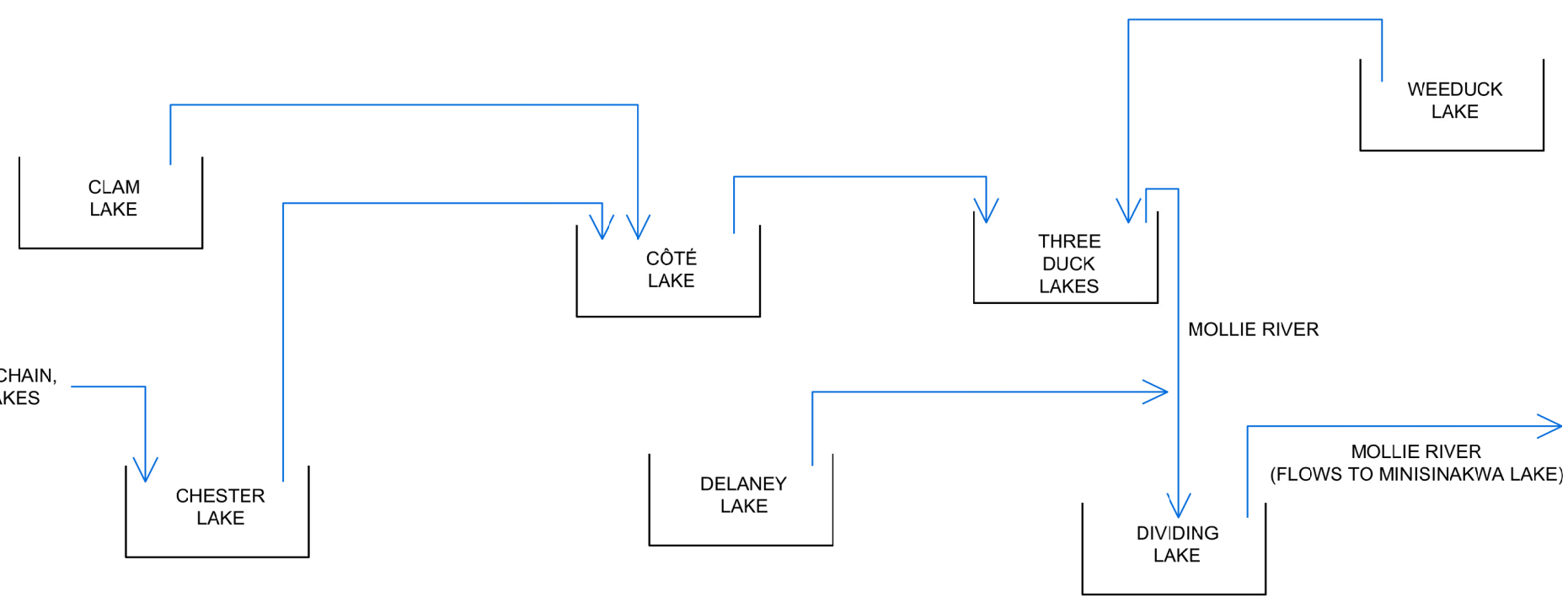

LEGEND
FLOW DIRECTION
— EXISTING / NATURAL

2013-11-15	WATERSHEDS FOR DISCUSSION	SK	JUL	XXX	XXX
REV	DATE	DES	CADD	CHK	RVV
PROJECT					
IAMGOLD		CÔTÉ GOLD PROJECT			
TITLE					
EXISTING CONDITIONS FLOW SCHEMATIC					
PROJECT No.13-1192-0021.1000 *****			FILE No. 1311920021A005		
DESIGN	SK	2014-01-31	SCALE NOT TO SCALE		
CADD	JUL	2014-01-31	FIGURE		
CHECK	SK	2014-01-31	3-1		
REVIEW	JMP	2014-01-31			

\\golder-gp\gms\Subsidiary\CAD-GIS\CAD\Projects\2013\13-1192-0021 IAMGold Cote Gold\Civil 3D\1311920021A005.dwg | Layout: Figure 3-1 | Modifier: tterez 07/01/2014 9:50 AM | Plotter: tterez 01/01/2014

INFLOW FROM SCHOU, PEBONISHEWI, BILLIE, OWATAWETNES, MOUSE, WOLF, VIVIAN, WHALSOM AND SOMME LAKES

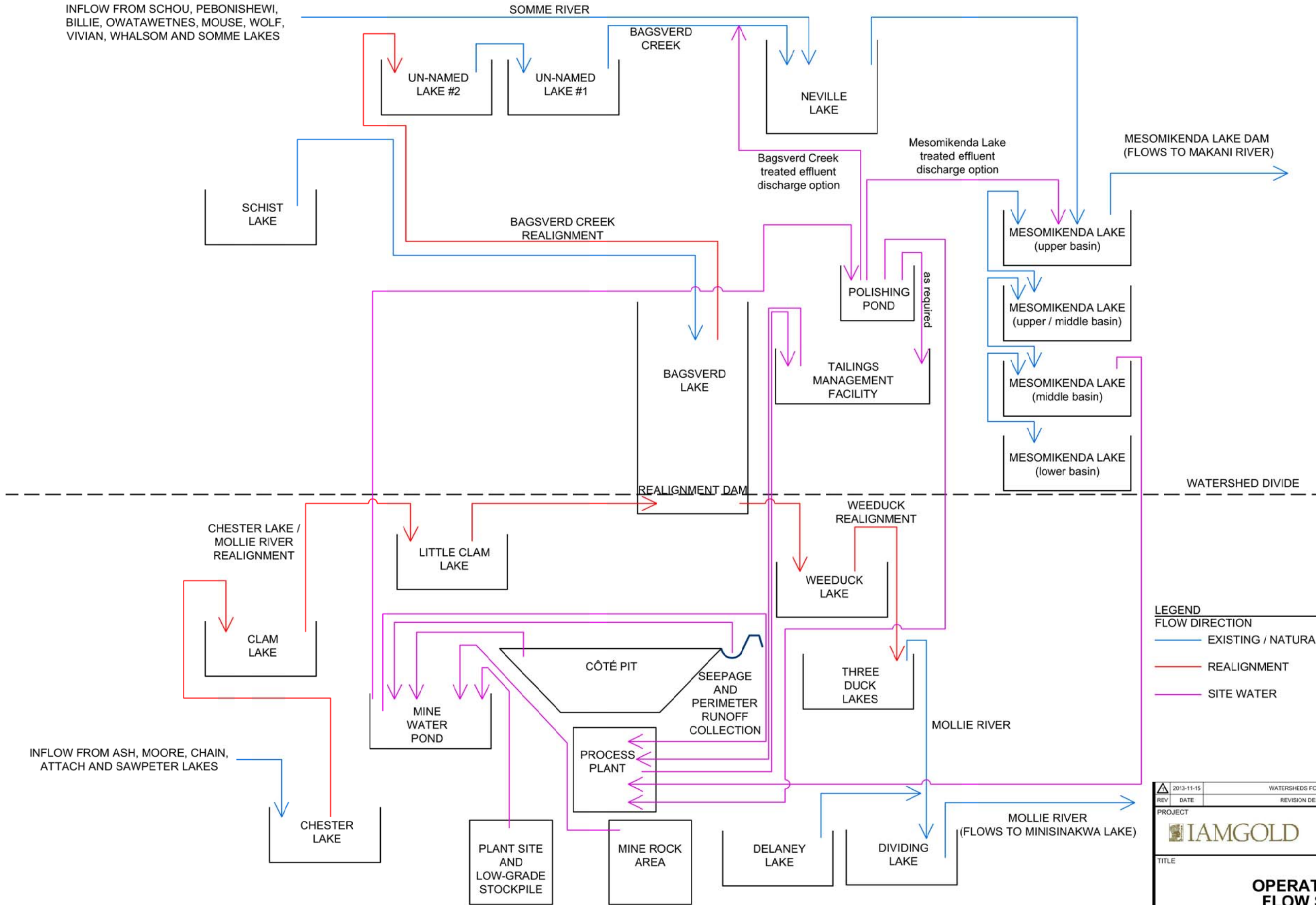

LEGEND
 FLOW DIRECTION
 ——— EXISTING / NATURAL
 ——— REALIGNMENT
 ——— SITE WATER

REV	DATE	REVISION DESCRIPTION	SK	JUL	XXX	XXX
			DES	CADD	CHK	RVW

PROJECT
IAMGOLD CÔTÉ GOLD PROJECT

**OPERATIONS PHASE
 FLOW SCHEMATIC**

PROJECT No.13-1192-0021.1000.****			FILE No.	1311920021A005
DESIGN	SK	2014-01-31	SCALE	NOT TO SCALE
CADD	JUL	2014-01-31	FIGURE	
CHECK	SK	2014-01-31		
REVIEW	JMP	2014-01-31		



I:\golder\golder\Subsury\CAD-CIS\CAD\Projects\2013\13-1192-0021 IAMGold Code Cad\CIVIL_3D\1311920021A005.dwg | Layout: Figure 4-1 | Modified: jleblond 04/03/2014 11:16 AM | Plotter: jleblond 08/17/2014

INFLOW FROM SCHOU, PEBONISHEWI, BILLIE, OWATAWETNES, MOUSE, WOLF, VIVIAN, WHALSOM AND SOMME LAKES

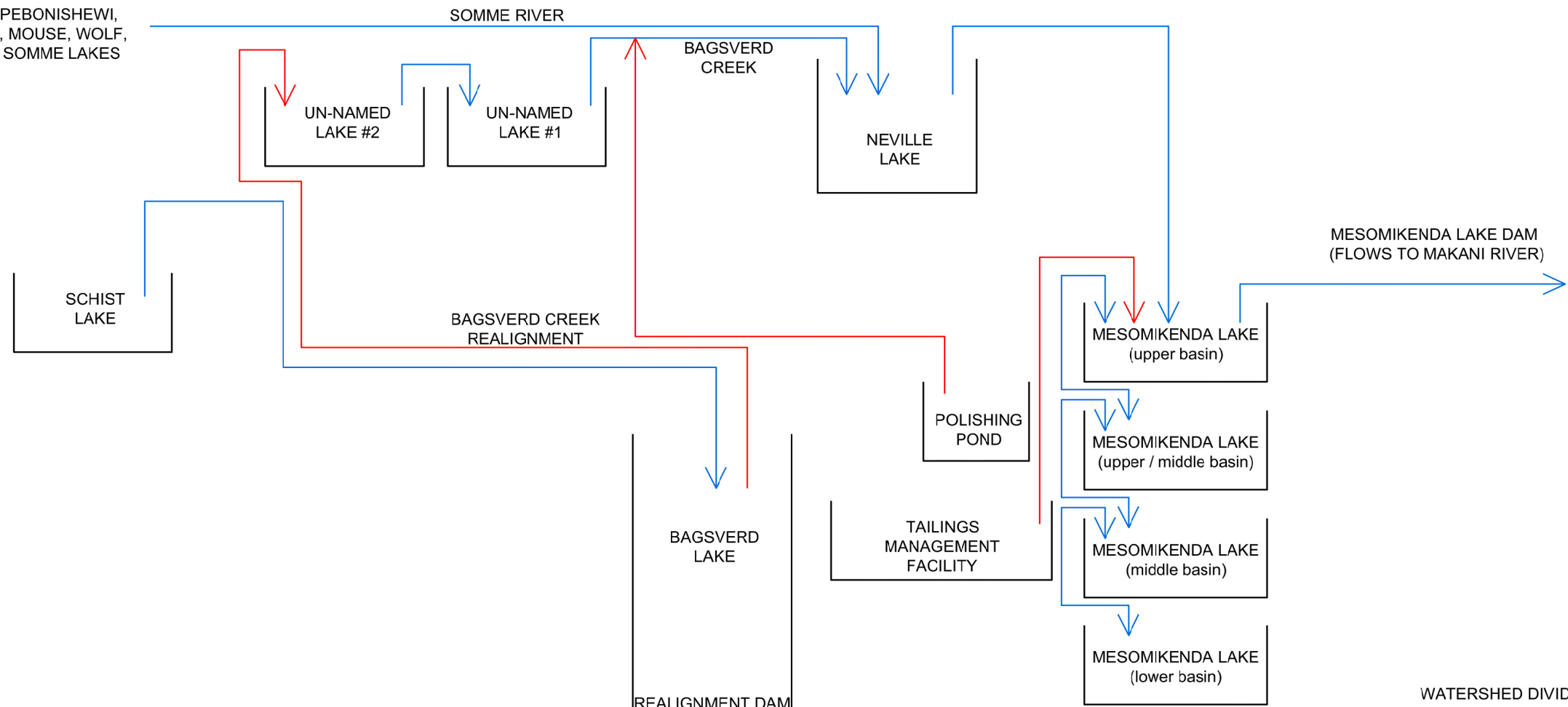

MESOMIKENDA LAKE DAM
(FLOWS TO MAKANI RIVER)

REALIGNMENT DAM

WATERSHED DIVIDE

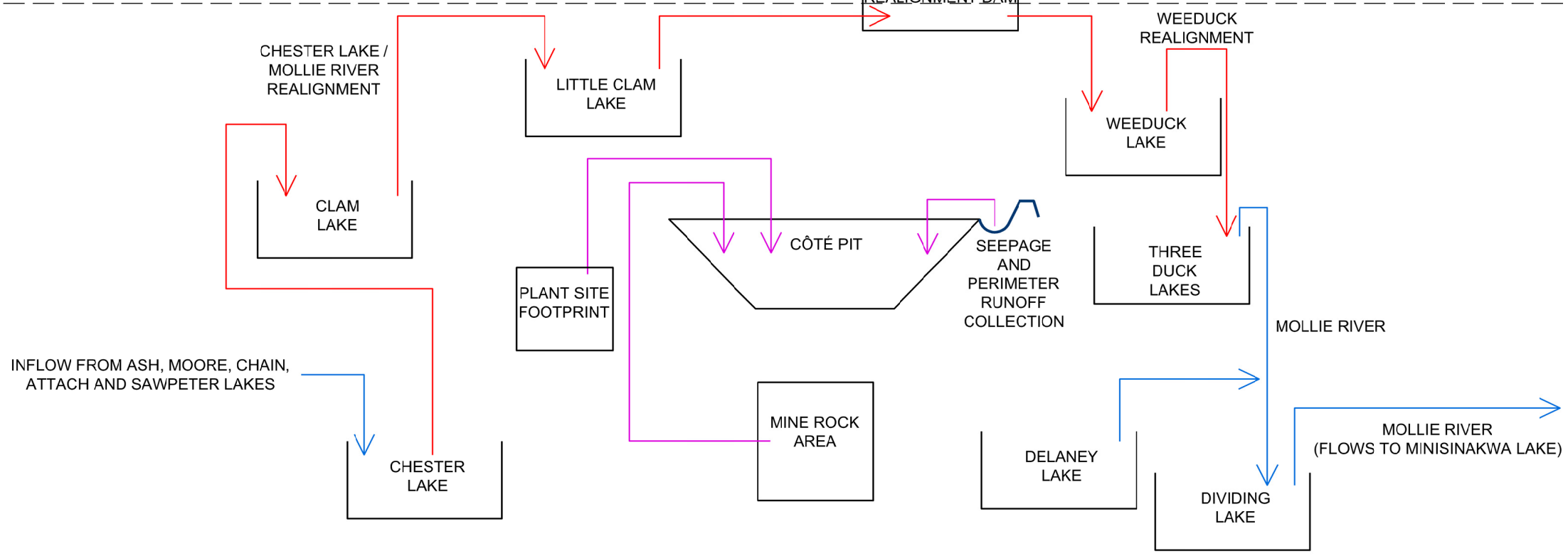

INFLOW FROM ASH, MOORE, CHAIN, ATTACH AND SAWPETER LAKES

LEGEND
FLOW DIRECTION
— EXISTING / NATURAL
— REALIGNMENT
— SITE WATER

2013-11-15	WATERSHEDS FOR DISCUSSION	SK	JUL	XXX	XXX
REV	DATE	DES	CADD	CHK	RWW
PROJECT					
IAMGOLD		CÔTÉ GOLD PROJECT			
TITLE					
POST - CLOSURE PHASE STAGE I FLOW SCHEMATIC					
PROJECT No.13-1192-0021.1000.****		FILE No.		1311920021A005	
DESIGN	SK	2014-01-31	SCALE	NOT TO SCALE	
CADD	JUL	2014-01-31	FIGURE	4-2	
CHECK	SK	2014-01-31			
REVIEW	JMP	2014-01-31			

I:\golder\gms\Subsidiary\CAD-CIS\CAD\Projects\2013\13-1192-0021 IAMGold Cote Gold\CIVIL_3D\1311920021A005.dwg | Layout: Figure 4-2 | Modified: terecz 01/31/2014 9:50 AM | Plotted: terecz 01/31/2014



INFLOW FROM SCHOU, PEBONISHEWI, BILLIE, OWATAWETNES, MOUSE, WOLF, VIVIAN, WHALSOM AND SOMME LAKES

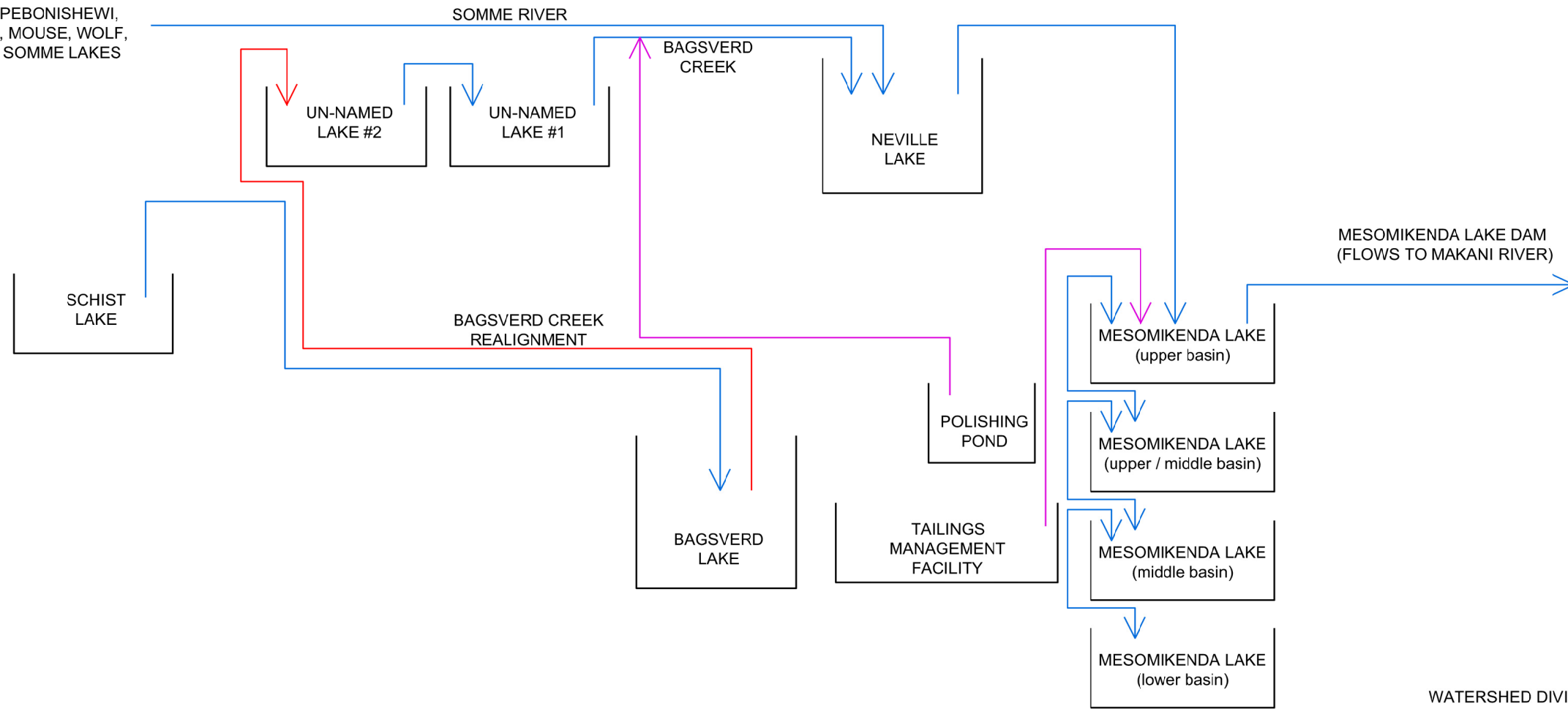

INFLOW FROM ASH, MOORE, CHAIN, ATTACH AND SAWPETER LAKES

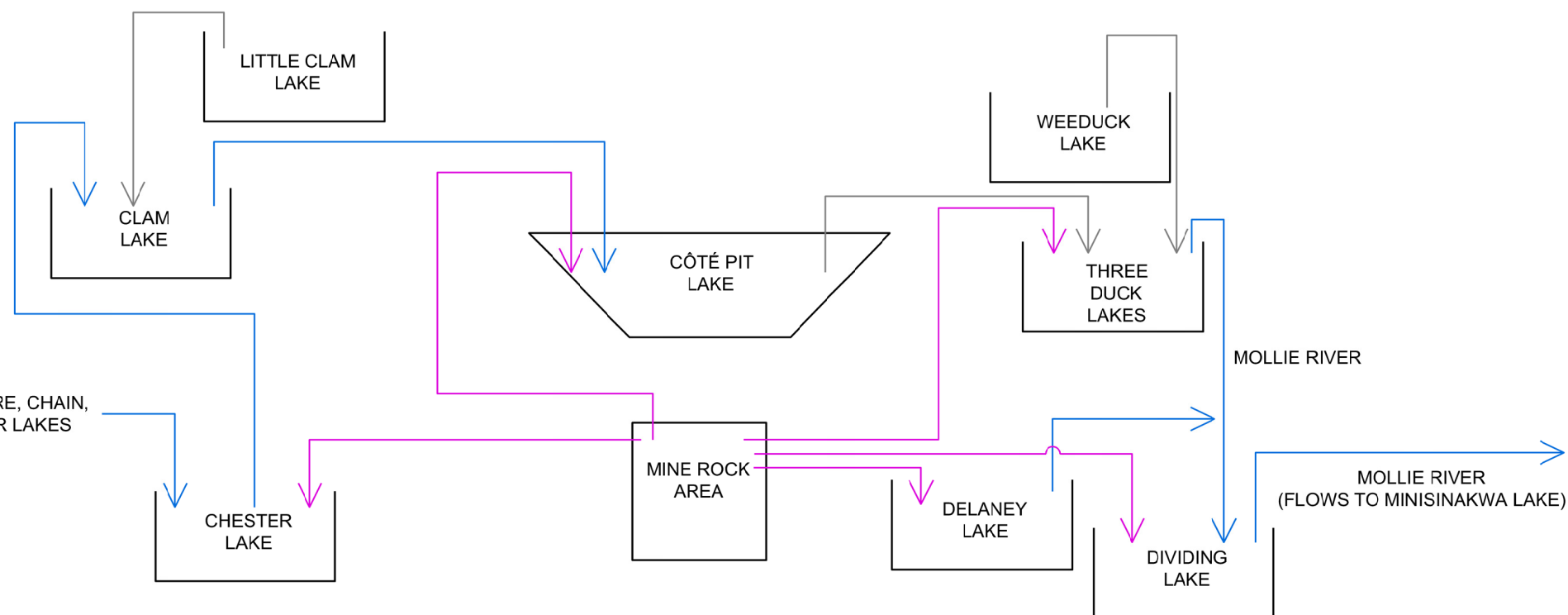

- LEGEND**
- FLOW DIRECTION
 - EXISTING / NATURAL
 - REALIGNMENT
 - SITE WATER
 - RESTORED OR REDIRECTED

REV	DATE	REVISION DESCRIPTION	DES	CADD	CHK	RVW
-----	------	----------------------	-----	------	-----	-----

PROJECT
IAMGOLD CÔTÉ GOLD PROJECT

TITLE
POST - CLOSURE PHASE STAGE II FLOW SCHEMATIC

PROJECT No.13-1192-0021-1000-****	FILE No.	1311920021A005
DESIGN SK 2014-01-31	SCALE	NOT TO SCALE
CADD JUL 2014-01-31	FIGURE	4-3
CHECK SK 2014-01-31		
REVIEW JMP 2014-01-31		



I:\golder\golder\Subsidiary\CAD-GIS\CAD\Projects\2013\13-1192-0021 IAMGold Cote Gold\Civil_3D\1311920021A005.dwg | Layout: Figure 4-3 | Modified: terecz 01/13/2014 9:50 AM | Plotted: terecz 01/13/2014



ATTACHMENT I

Hydrology Baseline Report, Côte Gold Project



October 15, 2014

IAMGOLD CORPORATION

Hydrology and Climate Baseline Report Côte Gold Project

Submitted to:
IAMGOLD Corporation
401 Bay Street, Suite 3200
PO Box 153
Toronto, ON M5H 2Y4

REVISED REPORT



Report Number: 13-1192-0010R (8000/8030)R

Distribution:

1 e-copy - IAMGOLD Corporation
3 copies - Golder Associates Ltd.





Table of Contents

1.0 INTRODUCTION	4
1.1 Overview of the Côté Gold Project	4
2.0 SCOPE OF WORK	7
3.0 STUDY AREA	7
4.0 METHODS	8
4.1 Desktop Methods	8
4.1.1 Climate and Meteorological Data	8
4.1.2 Hydrological Data	10
4.2 Field Methods	10
4.2.1 Surface Water Quantity Monitoring	10
4.2.2 Rating Curve and Continuous Streamflow Development	14
4.2.3 Bathymetry	14
4.2.4 Meteorology	15
5.0 RESULTS	15
5.1 Regional Climate	15
5.1.1 Literature Review	16
5.1.2 Regional Climate Monitoring Stations	16
5.2 4.2. Regional Hydrology	21
5.2.1 4.2.1 Literature Review	21
5.2.2 Mattagami River Water Management Plan	21
5.2.3 Mesomikenda Lake Dam	21
5.2.4 Minisinakwa Lake Dam	22
5.2.5 Mattagami River Source Water Protection Plan	22
5.2.6 Regional Hydrology Monitoring Locations	22
5.3 Local Meteorology	24
5.4 Local Hydrology	26
5.5 Local Watersheds	26
5.5.1 Mollie River Watershed	29
5.5.2 Mesomikenda Lake Watershed	29



HYDROLOGY AND CLIMATE BASELINE

5.5.3	Local Water Level	32
5.5.4	Local Streamflow.....	33
6.0	SUMMARY AND CONCLUSIONS	34
7.0	REFERENCES.....	35

TABLES

Table 1: Regional Climate Locations.....	8
Table 2: Regional Hydrological Stations.....	10
Table 3: Surface Water Quantity Monitoring Locations	13
Table 4: Regional Climate Stations - Reported Climate Normals.....	17
Table 5: Sudbury A – IDF Statistics (millimetre rainfall)	19
Table 6: Chapleau A – IDF Statistics (millimetre rainfall)	19
Table 7: Timmins Victor Power A - Statistics (millimetre rainfall)	20
Table 8: North Bay A - Statistics (millimetre rainfall)	20
Table 9: Mesomikenda Lake Dam - Operating Rules.....	21
Table 10: Minisinakwa Lake Dam - Operating Rules	22
Table 11: Regional and Local Meteorological Comparison	24
Table 12: Lake Feature Summary	26
Table 13: Water Level Recordings	32
Table 14: Streamflow Measurements.....	33

FIGURES

Figure 1: Project Location	5
Figure 2: Site Plan.....	6
Figure 3: Regional Climate and Hydrological Monitoring Locations	9
Figure 4: Local Hydrological Monitoring Locations (Southern Portion).....	11
Figure 5: Local Hydrological Monitoring Locations (Northern Portion)	12
Figure 6: Regional Discharge and Water Level.....	23
Figure 7: Local and Regional Meteorology Comparisons.....	25
Figure 8: Local Watershed Divide	28
Figure 9: Local Watersheds (Southern Portion)	30
Figure 10: Local Watersheds (Northern Portion).....	31



APPENDICES

APPENDIX A

Hydrological Monitoring Location Details

APPENDIX B

Hydrological Monitoring Location Surveys

APPENDIX C

Bathymetric Maps



1.0 INTRODUCTION

IAMGOLD Corporation (IAMGOLD) is planning to develop the Côté Gold Project (the Project) located approximately 20 kilometers (km) southwest of Gogama, 130 km southwest of Timmins, and 200 km northwest of Sudbury (Figure 1).

This document is one of a series of physical, biological and human environment baseline reports to describe the current environmental conditions at the Project site. These baseline reports are written with the intent to support the Environmental Assessment (EA) process.

1.1 Overview of the Côté Gold Project

IAMGOLD is planning to construct, operate and eventually reclaim a new open pit gold mine at the Côté Gold Project site.

The proposed site layout places the required mine-related facilities in close proximity to the open pit, to the extent practicable. The proposed site layout is presented in Figure 2 showing the approximate scale of the Côté Gold Project. The site plan will be refined further as a result of ongoing consultation activities, land purchase agreements and engineering studies.

As part of the proposed development of the Project, several water features will be fully or partially overprinted. These include Côté Lake, portions of Three Duck Lakes, Clam Lake, Mollie River/Chester Lake system and Bagsverd Creek. As a consequence, these water features will need to be realigned for safe development and operation of the open pit.

The major proposed Project components are expected to include:

- open pit;
- ore processing plant;
- maintenance garage, fuel and lube facility, warehouse and administration complex;
- construction and operations accommodations complex;
- explosives manufacturing and storage facility (emulsion plant);
- various stockpiles (low-grade ore, overburden and mine rock area [MRA]) in close proximity to the open pit;
- aggregate extraction with crushing and screening plants;
- Tailings Management Facility (TMF);
- on-site access roads and pipelines, power infrastructure and fuel storage facilities;
- potable and process water treatment facilities;
- domestic and industrial solid waste handling facilities (landfill);
- water management facilities and drainage works, including watercourse realignments; and
- transmission line and related infrastructure.

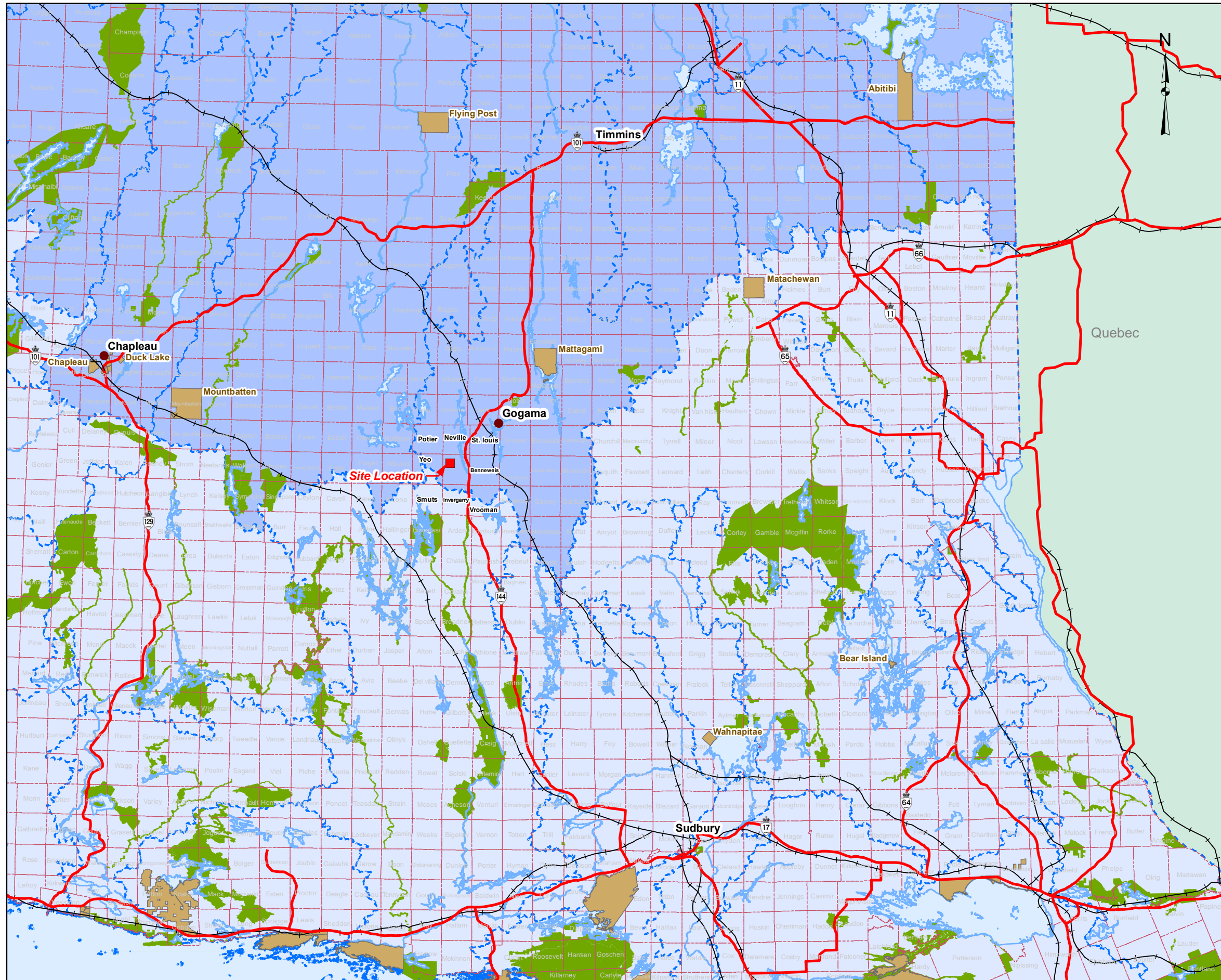

LEGEND

- Populated Places
- Major Roads
- Railway
- First Nations Communities
- Townships
- Provincial Park
- Primary Watersheds**
- Hudson Bay
- Great Lakes

REFERENCE

Base Data - MNR NRVIS, CANMAP v2008.4
 Produced by Golder Associates Ltd under licence from
 Ontario Ministry of Natural Resources, © Queens Printer 2013
 Projection: Transverse Mercator Datum: NAD 83 Coordinate System: UTM Zone 17

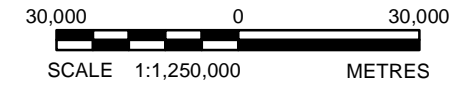

PROJECT		IAMGOLD CÔTÉ GOLD PROJECT	
TITLE			
Project Location			
<p>Golder Associates Sudbury, Ontario</p>	PROJECT No. 13-1192-0021	SCALE AS SHOWN	REV. 0
	DESIGN	RRD	Dec. 2012
	GIS	RRD	Nov. 2013
	CHECK	MO	Nov. 2013
	REVIEW	KAB	Nov. 2013
			FIGURE: 1

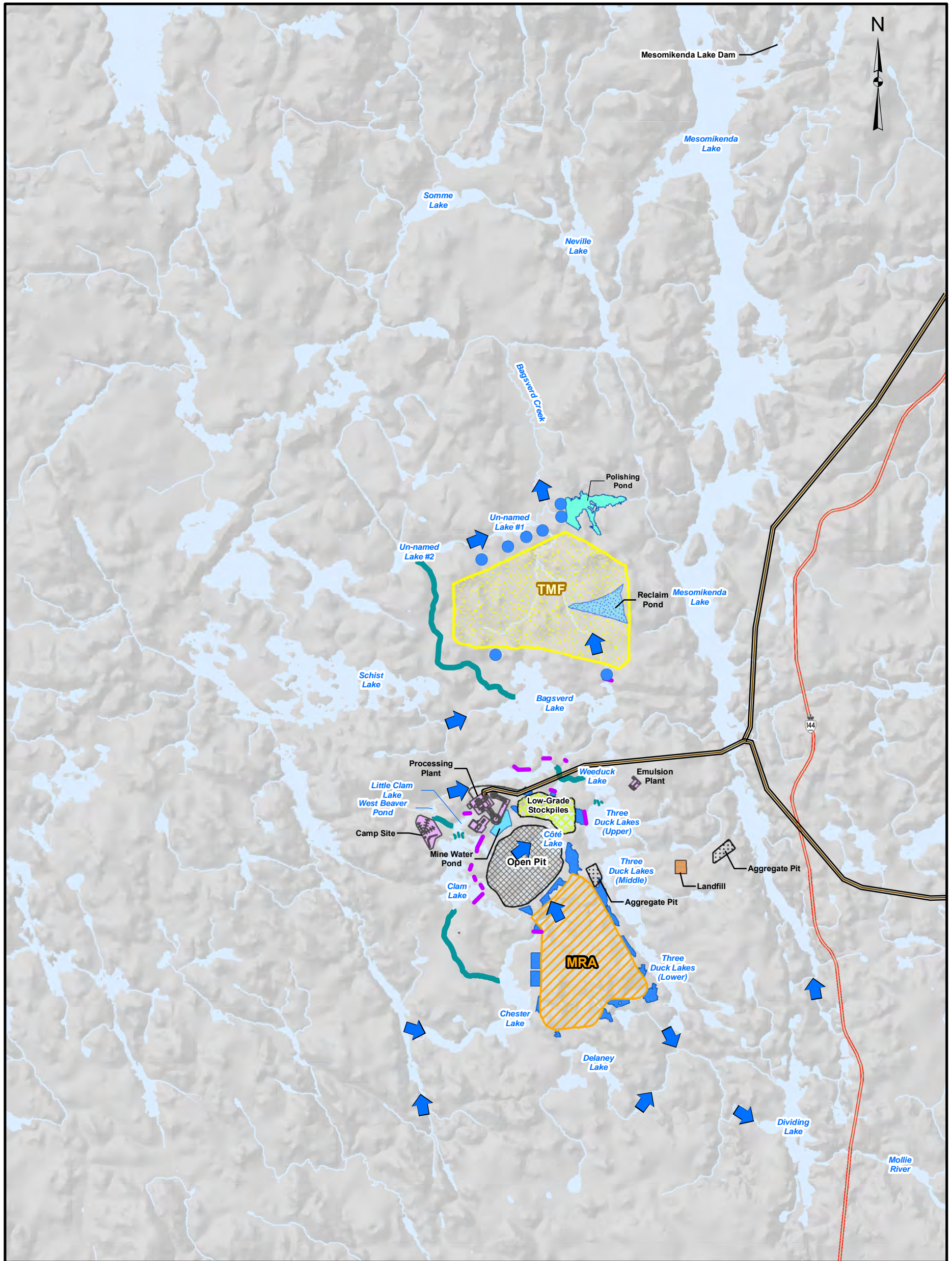

LEGEND

- Realignment Dams
- Polishing Pond
- Waterbodies
- Transmission Line
- Reclaim Pond
- Creek / River
- Watercourse Realignment
- Aggregate Pit
- Surface Water Flow Direction
- Highway 144
- Facilities
- Low-Grade Stockpiles
- Landfill
- Mine Rock Area (MRA)
- Collection Ponds
- Tailings Management Facility (TMF)
- Mine Water Pond
- Open Pit

REFERENCE

Open Pit Shell provided by IAMGOLD, May 2013
 Base Data - MNR NRVIS, CANMAP v2008.4
 Produced by Golder Associates Ltd under licence from Ontario Ministry of Natural Resources,
 © Queens Printer 2013
 Projection: Transverse Mercator Datum: NAD 83 Coordinate System: UTM Zone 17

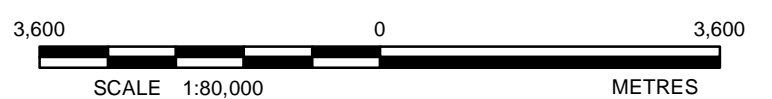

PROJECT		CÔTÉ GOLD PROJECT	
TITLE		Site Plan	
Golder Associates Sudbury, Ontario		PROJECT No. 13-1192-0021 DESIGN RRD Feb. 2013 GIS AL Oct. 2013 CHECK SK Nov. 2013 REVIEW KAB Nov. 2013	SCALE AS SHOWN REV. 0 <h2 style="text-align: center;">FIGURE: 2</h2>



2.0 SCOPE OF WORK

The scope of work for the hydrological and climatological baseline study presented herein was limited to:

- 1) Installation of a meteorological tower on the Project site.
- 2) Installation of hydrological (water level) monitoring equipment on waterways in the vicinity of the Project site.
- 3) Compilation of regional climatological information and comparison with data collected at the meteorological tower (from May 2012 to the end of July 2013).
- 4) Compilation of regional hydrological information and comparison with data collected at the local monitoring stations (from installation during 2012 to the end of July 2013).

The scope of work described herein is based on the following:

- 1) In the context of this report, the term 'baseline' is used to describe the conditions existing at the Project site as encountered during the time period of the hydrological study (March 2012 to July 2013).
- 2) The report summarizes factual information collected during the time periods referenced herein and water level and discharge monitoring is on-going.

3.0 STUDY AREA

The Project site is located in Chester and Neville Township, Sudbury District, southwest of the town of Gogama, Ontario and just north of the watershed divide that separates the James Bay watershed from the Great Lakes watershed (Figure 1).

The Boreal Shield ecozone of Ontario (Natural Resources Canada 2012) encompasses the Project site and is characterized by long, cold winters and short warm summers with annual water input exceeding losses to evaporation (Energy, Mines and Resources Canada 1990).

Surficial geology at the Project site is predominantly bedrock covered with a thin till veneer, with occasional glaciofluvial or glaciolacustrine deposits (Roed and Hallett 1979). Numerous lakes and rivers are a result of the geology, topography and annual water surplus conditions. Topography in the immediate vicinity of the Project site ranges from approximately 410 metres above sea level (masl) to 350 masl.

The Project site is located within the Mattagami River Watershed, which has headwaters to the south at the James Bay/Great Lakes watershed divide and flows north for approximately 420 km to a confluence with the Moose River, which subsequently flows to James Bay. Approximately 18 dams and power generating stations are located along the Mattagami River, which also provides drinking water to the City of Timmins, Ontario (110 km northeast of the Project site; Figure 1). The Mattagami River watershed, including the Project site, lies within the Mattagami Region Source Water Protection Area.

Key water control structures in the vicinity of the Project site are located on Mesomikenda Lake (owned by Ontario Power Generation [OPG]) and on Minisinakwa Lake (owned by the Ontario Ministry of Natural Resources [MNR]).



4.0 METHODS

4.1 Desktop Methods

The review of available literature and regional information was primarily provided by Environment Canada (EC), MNR, Water Survey of Canada (WSC) and OPG. Site specific data review and analysis was limited to:

- the compilation of available automatic water level recordings, manual staff gauge, instantaneous discharge, bathymetric data and survey measurements;
- the analysis of collected field data to estimate a continuous record of stream discharge for the studied period;
- the comparison of collected on-site meteorological data to regional climate stations;

This allowed for an overview of the range of meteorological and hydrological conditions at the Project site for the period March 2012 to July 2013.

4.1.1 Climate and Meteorological Data

As shown in Figure 3, existing EC Climate monitoring stations are located in Timmins (120 km north of the Project site), Chapleau (110 km northwest of the Project site), Sudbury (140 km southeast of the Project site) and North Bay (230 km southeast of the Project site). These monitoring stations were selected as representative regional monitoring sites for long-term climate and short-term meteorology data comparisons (Table 1). Climate data were extracted for these stations from EC databases (EC 2013).

Table 1: Regional Climate Locations

Location	EC ID	Latitude	Longitude	Distance from Project site (km)	Period of Record
Sudbury A	6068150	46 °37' 32" N	80 ° 47' 52" W	140 (SE)	1954 - 2013
Timmins Victor Power A ¹	6078285	48 ° 34' 11" N	81 ° 22' 36" W	120 (NE)	1955 - 2012
Timmins Climate	6078282	48 ° 33' 26" N	81 ° 23' 25" W	120 (NE)	2008 - 2013
Chapleau A	6061361	47 ° 49' 12" N	83 ° 20' 48" W	110 (NW)	1978 - 2013
North Bay A ¹	6085700	46 ° 21' 49" N	79 ° 25' 22" W	230 (SE)	1939 - 2012
North Bay A	6085701	46 ° 21' 50" N	79 ° 25' 22" W	230 (SE)	2013

Note:
¹ Station discontinued in 2012
km - kilometre

Path: Z:\Projects\2013\13-1192-0021\GIS\MXDs\Reporting\Hydrology\Figure3_Climate_WQ_Monitoring.mxd

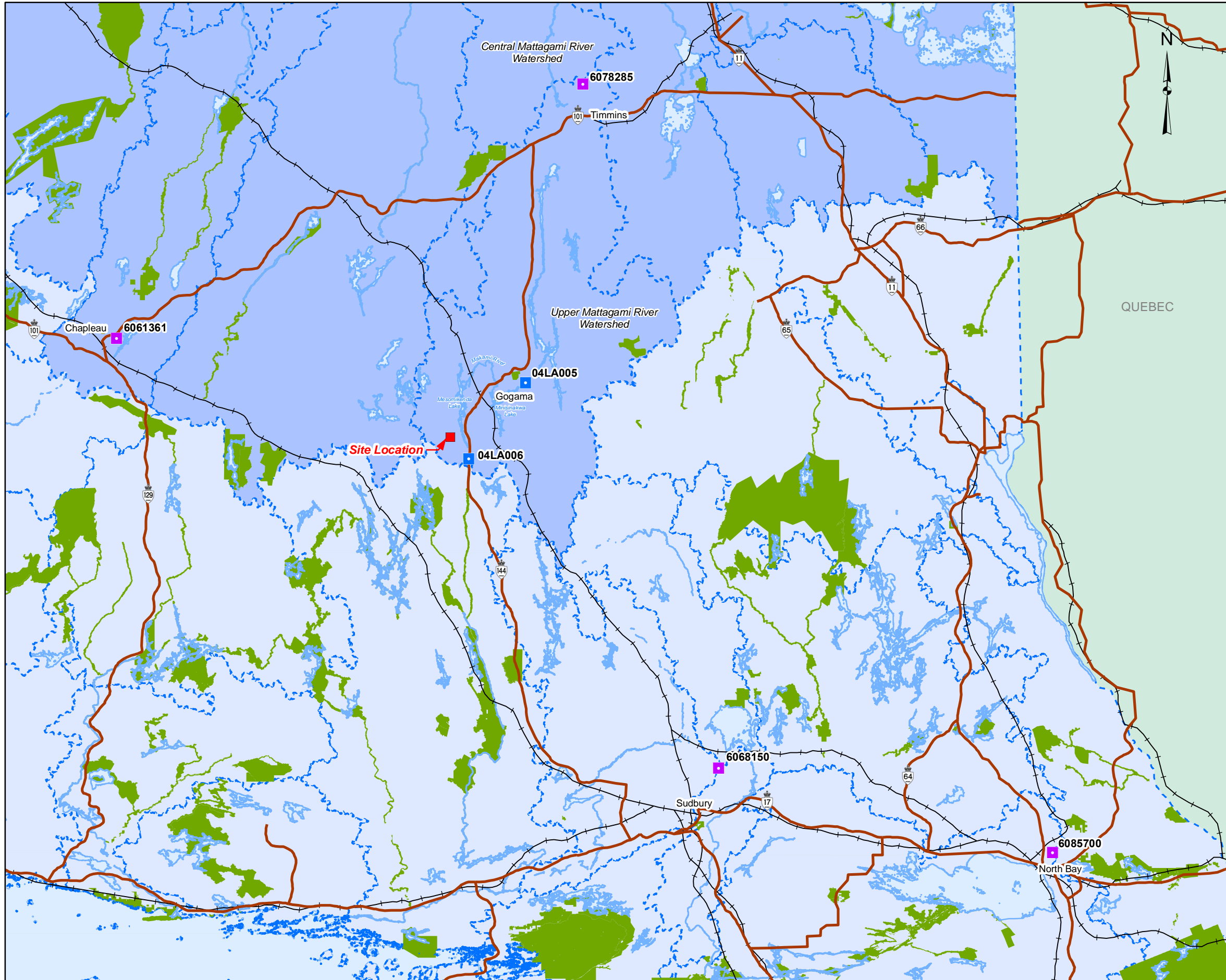

LEGEND

- Regional Climate Monitoring Station
- Regional Hydrological Monitoring Locations
- Populated Place
- Major Roads
- Railway
- Provincial Park

Primary Watersheds

- Hudson Bay
- Great Lakes

REFERENCE

Base Data - MNR NRVIS, CANMAP v2008.4
 Produced by Golder Associates Ltd under licence from
 Ontario Ministry of Natural Resources, © Queens Printer 2013
 Projection: Transverse Mercator Datum: NAD 83 Coordinate System: UTM Zone 17

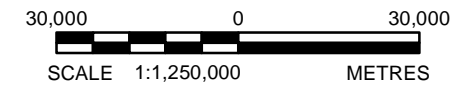

PROJECT		IAMGOLD CÔTÉ GOLD PROJECT																					
TITLE																							
Regional Climate and Hydrology Monitoring Locations																							
Golder Associates Sudbury, Ontario		<table border="1" style="font-size: small;"> <tr> <td>PROJECT No.</td> <td>13-1192-0021</td> <td>SCALE AS SHOWN</td> <td>REV. 0</td> </tr> <tr> <td>DESIGN</td> <td>RRD Dec. 2012</td> <td></td> <td></td> </tr> <tr> <td>GIS</td> <td>RRD Jul. 2013</td> <td></td> <td></td> </tr> <tr> <td>CHECK</td> <td>SK Nov. 2013</td> <td></td> <td></td> </tr> <tr> <td>REVIEW</td> <td>JMP Nov. 2013</td> <td></td> <td></td> </tr> </table>	PROJECT No.	13-1192-0021	SCALE AS SHOWN	REV. 0	DESIGN	RRD Dec. 2012			GIS	RRD Jul. 2013			CHECK	SK Nov. 2013			REVIEW	JMP Nov. 2013			<p>FIGURE: 3</p>
PROJECT No.	13-1192-0021	SCALE AS SHOWN	REV. 0																				
DESIGN	RRD Dec. 2012																						
GIS	RRD Jul. 2013																						
CHECK	SK Nov. 2013																						
REVIEW	JMP Nov. 2013																						



4.1.2 Hydrological Data

Active regional hydrological monitoring stations with available data were selected to provide an indication of temporal trends in water level and discharge in waterways in the vicinity of the Project site and are located within the Upper Mattagami River watershed (Figure 3; Table 2). Water quantity (water level and discharge) data were collected from databases provided by WSC (2012) and OPG for these regional monitoring stations.

Table 2: Regional Hydrological Stations

Table with 9 columns: Location, EC ID, Latitude, Longitude, Watershed, Approximate Drainage Area (km²), Parameters, Period of Record (for current study), Data Provider. Rows include Mollie River at Highway 144, Minisinakwa River Near Gogama, and Mesomikenda Lake at Mesomikenda Lake Dam.

Note: km² – kilometre squared, N – north, W - west

4.2 Field Methods

4.2.1 Surface Water Quantity Monitoring

Surface water monitoring sites were selected in cooperation with Trelawney Mining, prior to IAMGOLD acquiring the property, based on the infrastructure and mining plan as it existed in early 2012. Fifteen surface water monitoring locations were selected, 14 of which were instrumented with automatic water level pressure dataloggers (Solinst Leveloggers; Figure 4 and Figure 5). A barometric pressure datalogger was installed at an elevation above the expected high water level at one surface water monitoring location in order to correct water level pressures to a representative water level (m).

The dataloggers were installed in 1" (2.54 cm) PVC pipes attached to posts that were either driven into stream substrate, bolted to the exterior of culvert inlets or bolted to rock faces. A staff gauge was also installed at each location in order to correlate the automatic recording to manual water level measurements.

Where a flow restriction was present (such as culvert, roadway or beaver dam), the water level monitoring station was installed upstream of this feature. Initial installations occurred in March 2012. IAMGOLD personnel supplemented these initial installations with others as infrastructure improvements (i.e. culvert installations) were completed. The Project site surface hydrological monitoring locations are summarized in Table 3 and Figure 4 and Figure 5, and individual site descriptions are provided in Appendix A.

Path: Z:\Projects\2013\13-1192-0021\GIS\MXDs\Reporting\Hydrology\Figure4_Hydrological_Monitoring_South.mxd

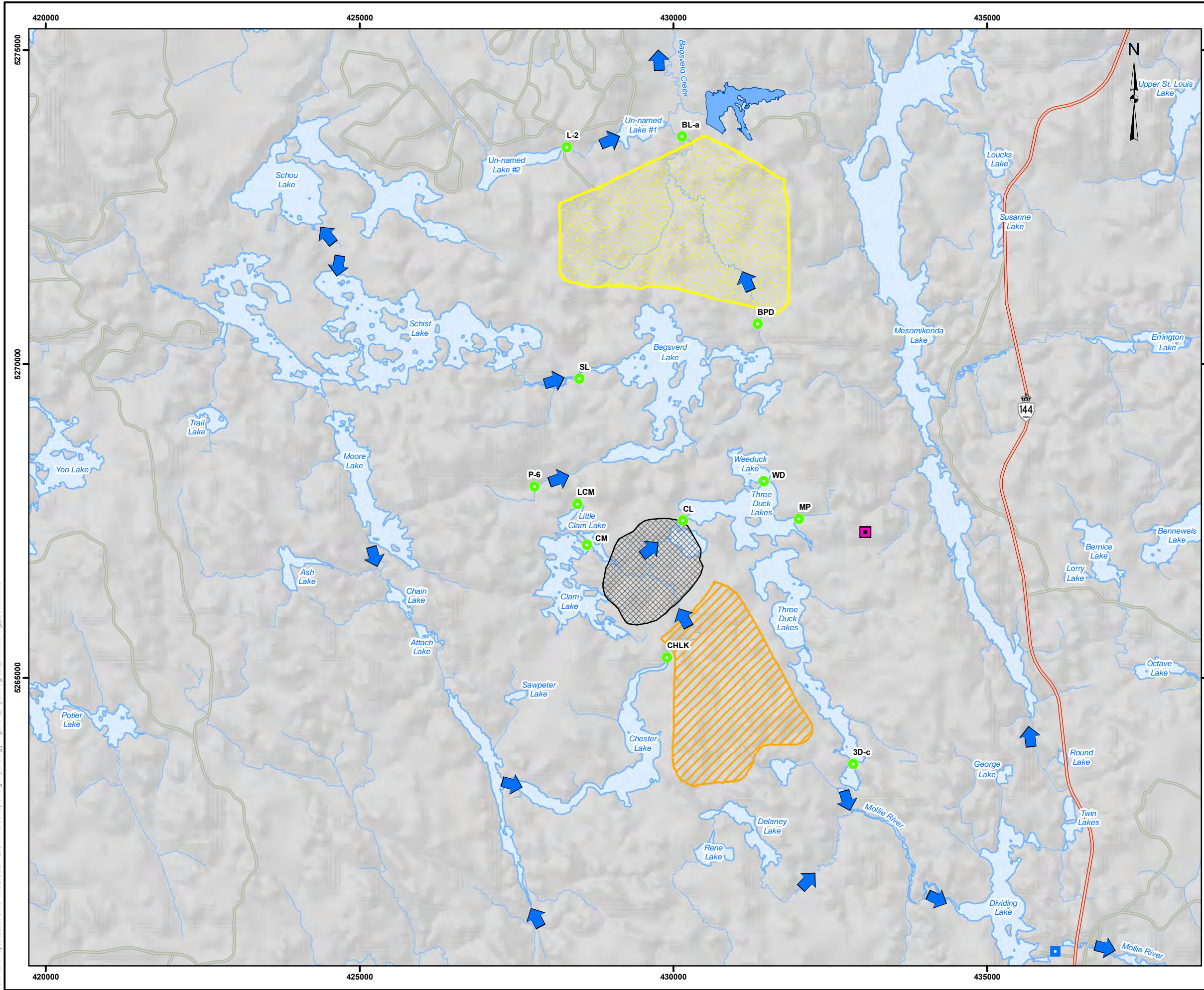

LEGEND

- Automatic Water Level & Manual Water Flow (Monthly)
- Automatic Water Level & Manual Water Flow (Quarterly)
- ▲ Manual Water Flow (Quarterly)
- Meteorological Station
- Regional Hydrological Monitoring Location
- Major Road
- Open Pit
- Polishing Pond
- Tailings Management Facility (TMF)
- Mine Rock Area (MRA)
- Waterbodies
- ~ Rivers

REFERENCE

Open Pit Shell provided by IAMGOLD, May 2013
 Base Data - MNR NRVIS, CANMAP v2008.4
 Produced by Golder Associates Ltd under licence from
 Ontario Ministry of Natural Resources, © Queens Printer 2013
 Projection: Transverse Mercator Datum: NAD 83 Coordinate System: UTM Zone 17

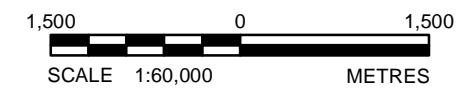

PROJECT		IAMGOLD CÔTÉ GOLD PROJECT	
TITLE		Local Hydrological Monitoring Locations (Southern Portion)	
	PROJECT No. 13-1192-0021	SCALE AS SHOWN	REV. 0
DESIGN	RRD	Dec. 2012	FIGURE: 4
GIS	AL	Oct. 2013	
CHECK	SK	Nov. 2013	
REVIEW	KAB	Nov. 2013	

Path: Z:\Projects\2013\13-1192-0021\GIS\MXDs\Reporting\Hydrology\Figure5_Hydrological_Monitoring_North.mxd

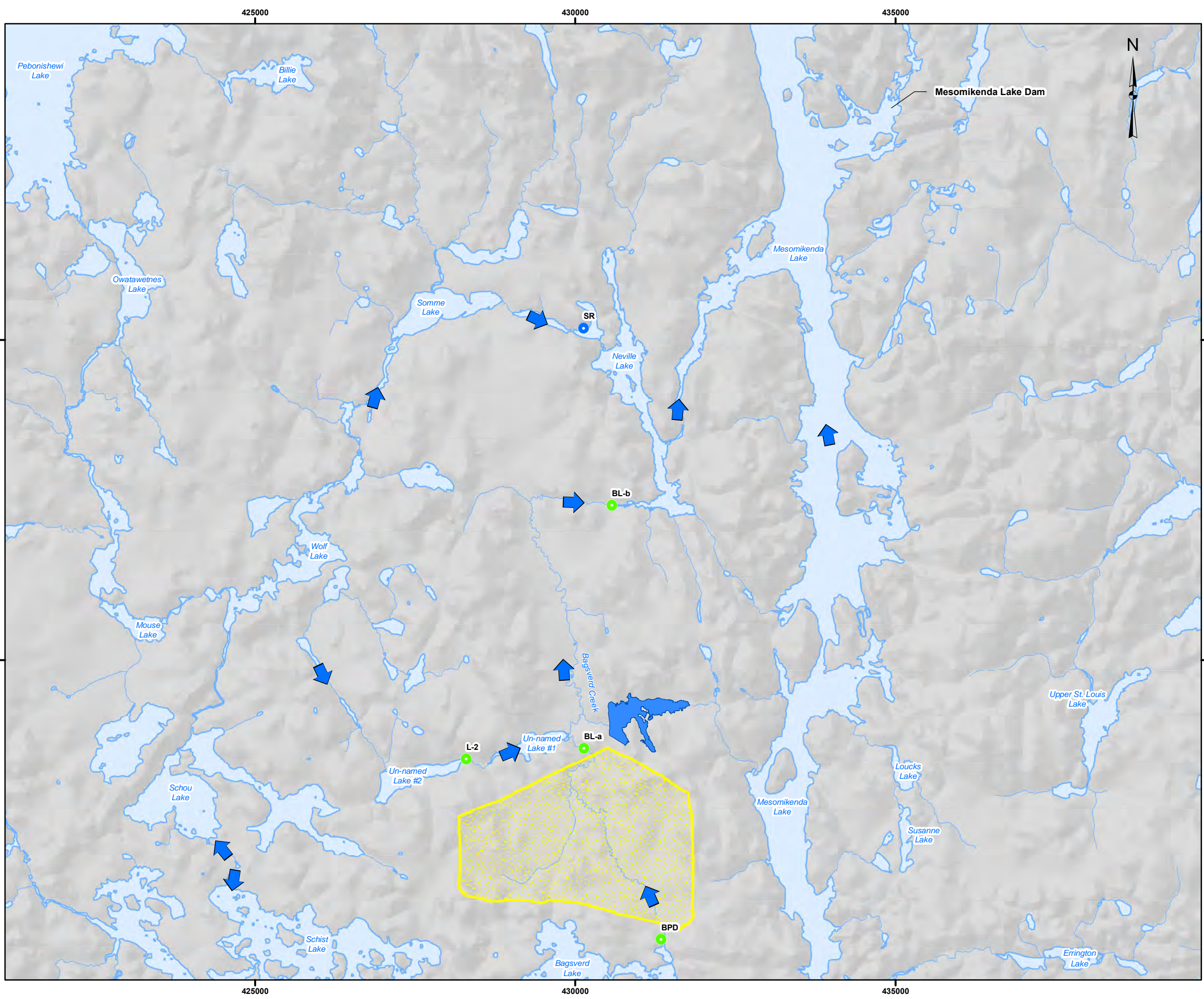

LEGEND

- Automatic Water Level & Manual Water Flow (Monthly)
- Automatic Water Level & Manual Water Flow (Quarterly)
- ▲ Manual Water Flow (Quarterly)
- Meteorological Station
- Polishing Pond
- Tailings Management Facility (TMF)
- ▭ Waterbodies
- Rivers

REFERENCE

Open Pit Shell provided by IAMGOLD, May 2013
 Base Data - MNR NRVIS, CANMAP v2008.4
 Produced by Golder Associates Ltd under licence from
 Ontario Ministry of Natural Resources, © Queens Printer 2013
 Projection: Transverse Mercator Datum: NAD 83 Coordinate System: UTM Zone 17



PROJECT		CÔTÉ GOLD PROJECT	
TITLE			
Local Hydrological Monitoring Locations (Northern Portion)			
PROJECT No. 13-1192-0021		SCALE AS SHOWN	REV. 0
DESIGN	RRD	Dec. 2012	FIGURE: 5
GIS	AL	Oct. 2013	
CHECK	SK	Nov. 2013	
REVIEW	KAB	Nov. 2013	
Golder Associates Sudbury, Ontario			



HYDROLOGY AND CLIMATE BASELINE

Surveys of these surface water installation locations were completed by L. Labelle Surveys in June and October 2012 (and checked in September 2013), which provided geodetic references for each staff gauge (Appendix B). The October 2012 survey also identified downstream control points (i.e. zero flow elevations) and where applicable, culvert dimensions.

Streamflow measurements were made at each location (either monthly or quarterly) through standard velocity-area methods, using a wading rod and velocity meter. Velocity profiles were completed downstream of the flow control feature (e.g. culvert). Velocity was measured at 0.6 of water depth, except when water depth exceeded 0.75 m, in which case velocity was measured at both 0.2 and 0.8 of water depth. The in-field measurements and concurrent datalogger downloads were made by IAMGOLD staff, assisted by Golder during the March 2012 field visit. Data provided in this report is limited to March 2012 to July 2013; however, hydrological monitoring is ongoing at the Project site.

Table 3: Surface Water Quantity Monitoring Locations

Site ID	Location Description	Northing (NAD83 Zone 17N)	Easting (NAD83 Zone 17N)	Upstream Drainage Area (km ²) ¹	Period of Record (for current study)
BL-b	Bagsverd Creek Outflow	5277424	430561	80	July 5, 2012 - July 31, 2013
BL-a	Bagsverd Creek at Un-named Lake #1	5273627	430136	52	March 30, 2012 – July 31, 2013
BPD	Bagsverd Lake Outflow	5270639	431343	40	March 30, 2012 – July 31, 2013
L-2	Un-named Lake #2 Outflow	5273456	428297	12	March 30, 2012 – July 31, 2013
SL	Schist Lake Outflow	5269771	428496	31	March 30, 2012 - July 31, 2013
P-6	West Beaver Pond Outflow	5268056	427783	2	May 14, 2012 - July 31, 2013
SR	Somme River Outflow	5280152	429894	199	March 30, 2012 - July 31, 2013
LCM	Little Clam Lake Outflow	5267779	428484	0.3 ²	April 30, 2012 – July 31, 2013
CHLK	Chester Lake Outflow	5265373	429883	33	May 29, 2012 - June 27, 2013
CL	Côté Lake Outflow	5267486	430164	43	October 10, 2012 – July 31, 2013
MP	Mill Pond Outflow	5267531	431992	1	March 30, 2012 – July 31, 2013
CM	Clam Lake Outflow	5267121	428624	4	March 30, 2012 – July 31, 2013
WD	Weeduck Lake Outflow	5268135	431442	1	March 30, 2012 – July 31, 2013



Site ID	Location Description	Northing (NAD83 Zone 17N)	Easting (NAD83 Zone 17N)	Upstream Drainage Area (km ²) ¹	Period of Record (for current study)
3D-C	Three Duck Lakes Outflow	5263621	432867	54	March 30, 2012 – June 24, 2013

Notes:

NAD - North American Datum

km² – kilometres squared

¹ Drainage Area includes upstream stations

² Decimal place added for clarity

4.2.2 Rating Curve and Continuous Streamflow Development

Continuous estimates of streamflow were completed through the development of rating curves for each of the monitoring locations summarized in Table 3. The following information was used in the development of these rating curves:

- continuously logged water level data;
- manual instantaneous stream velocity and discharge measurements;
- manual staff gauge readings (concurrent to the stream velocity/discharge measurements); and
- field surveys of installations and associated streambed/crossings.

The instantaneous discharge measurements were correlated to the manual staff gauge readings, and a zero-flow elevation correction was applied based on this data and the field surveys. The zero flow elevation was a site-specific downstream control such as a beaver dam or streambed. Several of these rating curves were affected by ongoing beaver activity (blockage of culverts or dam development). In these cases, rating curves were adjusted to reflect flow conditions pre- and post- beaver activity.

Rating curves were applied to the continuous water level data after barometric compensation of the water level data (i.e. the removal of atmospheric pressure from the total pressure recorded at the water level sensors). This provided an estimate of daily discharge at each of the hydrological monitoring stations.

Winter corrections for discharge with ice cover were not applied to these estimates of streamflow for the period of study, as unsafe ice conditions existed at several of the monitoring stations. Locations with culverts were typically ice free for winter 2012 to 2013, but may have had other downstream ice effects on water level at the monitoring site. As such, there is a period of increased uncertainty in the estimated discharge measurements during the winter months. An increased period of uncertainty was also recognized for the highest flow periods during spring 2013; where water level response due to snowmelt was rapid.

4.2.3 Bathymetry

Bathymetric data provided by IAMGOLD was supplemented with data collected during spring and summer 2013. Additional data was collected using a Garmin Map 298 Bathymetric Global Positioning System, which collected both spatial (latitude and longitude) and depth (m) information concurrently. The bathymetric data collected in 2013 was for the following water bodies:



- Neville Lake;
- Un-named Lake #1;
- Un-named Lake #2;
- Dividing Lake;
- Delaney Lake;
- Pond 4 (also referred to as Un-named Lake #3); and
- the connecting inlet bay from Neville Lake to Mesomikenda Lake.

The bathymetric data was collected as point files (x,y,z) and was subsequently interpolated to produce bathymetric contour lines with a contour interval of 1 m. Bathymetric maps are provided in Appendix C.

4.2.4 Meteorology

An on-Project site meteorological tower was installed by Golder and IAMGOLD staff at location 5267365N, 433039E (North American Datum 83, Zone 17N) on May 16 and May 17, 2012 (Figure 3). The station includes the following sensors mounted on a 10 m tower:

- air temperature;
- relative humidity;
- wind speed;
- wind direction; and
- solar radiation.

In addition, a tipping bucket precipitation collector was located southeast of the tower base. The sensors were connected to a Campbell Scientific CR1000 datalogger supplied with power from IAMGOLD. This power supply was also connected to a heater within the precipitation collector, allowing for snowfall to be recorded.

Meteorological data was logged each hour and was collected approximately quarterly from the datalogger. The collected data was compared to regional climate stations for consistency of data.

5.0 RESULTS

5.1 Regional Climate

Regional climate information was available from previous public domain literature as well as from climate monitoring stations that are maintained by EC.



5.1.1 Literature Review

Mean annual precipitation for the region is approximately 800 mm to 900 mm with wetter conditions to the south and drier conditions to the north and west of the Project site (Fisheries and EC 1978). Mean annual lake evaporation follows a northward decreasing trend from Sudbury to Gogama and is in the range of 500 mm to 600 mm (MNR 1984), while average annual evapotranspiration for the area between Sudbury and Timmins has been estimated to be in the range of 400 mm to 500 mm (MNR 1984). The difference between mean annual precipitation and evapotranspiration is the water surplus, or the amount of water available for stream runoff and groundwater recharge. Based on these average annual values, the annual water surplus for the region is in the range of 200 mm to 500 mm.

5.1.2 Regional Climate Monitoring Stations

Active Regional Climate monitoring locations are located in Timmins (120 km north of the Project site), Chapleau (110 km NW of the Project site), Sudbury (140 km south of the Project site) and North Bay (230 km southeast of the Project site). EC 30-year Climate Normal Statistics for 1981 to 2010 at each location are summarized in Table 4.

The total precipitation gradient shows a decreasing trend northward (to Timmins) and westward (to Chapleau), which is consistent with gradients noted in Fisheries Canada and EC (1978). The proportion of total precipitation that falls as snow is reported as 37% at Timmins and 29% at Sudbury.

Wind direction is not reported for the Chapleau monitoring location. Although there are location-specific differences in the monthly distribution of wind direction at the North Bay, Timmins and Sudbury monitoring stations, each of these sites report wind predominantly from the north through the winter and spring months, and wind predominantly from the south and southwest during summer and fall months.

The reported 1981 to 2010 climate normals provide a snapshot of the spatial variation in the four locations; however data more recent than the year 2010 was required in order to compare regional climate stations to the on-site meteorological tower data (Section 3.2.2). Therefore these climate normals have been supplemented with more recent records to provide comparison, and are further described in Section 5.3.

In addition to long term climate estimates, EC provided Intensity-Duration-Frequency (IDF) data for climate monitoring stations with a sufficient record period (EC 2012). Table 5 through Table 8 display IDF statistics for the Sudbury A, Chapleau A, Timmins Victor Power A and North Bay A climate monitoring sites, respectively.



HYDROLOGY AND CLIMATE BASELINE

Table 4: Regional Climate Stations - Reported Climate Normals

Location	Parameter	January	February	March	April	May	June	July	August	September	October	November	December	Annual
TEMPERATURE														
Chapleau (1981-2010)	Daily Average (°C)	-15.6	-13.2	-7.1	1.7	9.5	14.8	17.2	15.9	11.2	4.2	-3.2	-11.2	2.0
Timmins (1981-2010)	Daily Average (°C)	-16.8	-14.0	-7.4	1.8	9.6	14.9	17.5	16.0	11.1	4.4	-3.4	-11.9	1.8
Sudbury (1981-2010)	Daily Average (°C)	-13.0	-10.8	-4.9	3.8	11.1	16.5	19.1	18.0	13.0	6.0	-1.0	-8.6	4.1
North Bay (1981-2010)	Daily Average (°C)	-12.5	-10.4	-4.5	4.0	11.2	16.3	18.9	17.7	13.0	6.2	-0.8	-8.3	4.2
PRECIPITATION														
Chapleau (1981-2010)	Rainfall (mm)	2.0	1.8	12.7	28.7	66.0	80.3	82.2	76.0	94.7	71.0	24.0	5.9	545.1
	Snowfall (cm)	55.6	45.6	36.6	23.4	3.8	0.0	0.0	0.0	0.3	11.5	42.2	62.7	281.5
	Precipitation (mm)	51.9	42.9	46.9	52.7	69.9	80.3	82.2	76.0	95.1	83.1	64.4	63.7	809.0
Timmins (1981-2010)	Rainfall (mm)	3.2	1.7	14.1	30.1	62.3	83.2	90.9	81.6	83.7	68.1	30.9	8.5	558.3
	Snowfall (cm)	57.8	45.9	44.8	27.2	5.0	0.2	0.0	0.0	1.0	15.1	49.0	65.2	311.3
	Precipitation (mm)	51.8	41.3	54.5	56.2	67.4	83.4	90.9	81.6	84.7	82.5	75.9	64.5	834.6



HYDROLOGY AND CLIMATE BASELINE

Location	Parameter	January	February	March	April	May	June	July	August	September	October	November	December	Annual
Sudbury (1981-2010)	Rainfall (mm)	11.9	7.2	27.9	49.7	81.4	80.3	76.9	85.5	101.0	84.9	52.3	16.6	675.7
	Snowfall (cm)	59.5	51.7	34.9	16.9	1.9	0.0	0.0	0.0	0.1	5.7	29.6	63.0	263.4
	Precipitation (mm)	62.2	51.1	60.5	65.7	83.4	80.3	76.9	85.4	101.1	90.9	78.5	67.5	903.3
North Bay (1981-2010)	Rainfall (mm)	19.3	11.8	31.8	56.3	93.1	98.0	99.4	90.6	115.2	99.1	65.5	22.7	802.8
	Snowfall (mm)	65.3	58.6	39.5	16.7	3.2	0.1	0.0	0.0	0.1	8.1	38.0	70.1	299.6
	Precipitation (mm)	68.9	57.1	64.6	71.6	96.3	98.3	99.4	90.6	115.4	106.6	98.1	77.8	1044.6

WIND

Timmins (1981-2010)	Most Frequent Direction	NW	S	NW	N	N	S	W	S	S	S	S	S	S
Sudbury (1981-2010)	Most Frequent Direction	N	N	N	N	N	SW	SW	SW	SW	S	S	SW	SW
North Bay A (1981-2010)	Most Frequent Wind Direction	N	N	N	N	SW	SW	SW	SW	SW	SW	W	W	SW

Note:
 Data Source: EC 2013
 °C – degree Celcius
 cm - centimetre
 mm – millimetres



Table 5: Sudbury A – IDF Statistics (millimetre rainfall)

Duration (minutes)	Return Period (years)					
	2	5	10	25	50	100
5	7.0	9.8	11.7	14.0	15.8	17.5
10	10.2	14.2	16.8	20.1	22.5	24.9
15	12.6	17.2	20.2	24.0	26.9	29.7
30	16.8	23.5	28.0	33.7	37.9	42.0
60	20.6	28.8	34.2	41.0	46.1	51.1
120	25.4	35.3	41.8	50.1	56.3	62.4
360	35.7	46.5	53.7	62.7	69.5	76.1
720	43.3	55.8	64.1	74.7	82.5	90.2
1,440	49.4	64.6	74.6	87.4	96.8	106.2

Note:
Data Source: EC 2012

Table 6: Chapleau A – IDF Statistics (millimetre rainfall)

Duration (minutes)	Return Period (years)					
	2	5	10	25	50	100
5	7.3	10.1	12.0	14.3	16.0	17.8
10	10.6	14.2	16.5	19.4	21.6	23.8
15	12.3	16.4	19.1	22.4	24.9	27.4
30	15.2	20.6	24.1	28.6	31.9	35.2
60	19.4	26.5	31.3	37.2	41.7	46.0
120	23.0	31.0	36.3	43.1	48.1	53.0
360	32.6	44.2	51.8	61.5	68.6	75.7
720	40.0	55.1	65.2	77.9	87.3	96.6
1,440	48.3	64.8	75.8	89.6	99.9	110.1

Note:
Data Source: EC 2012



Table 7: Timmins Victor Power A - Statistics (millimetre rainfall)

Duration (minutes)	Return Period (years)					
	2	5	10	25	50	100
5	6.8	9.0	10.5	12.3	13.7	15.1
10	9.8	13.4	15.8	18.8	21.1	23.3
15	11.6	15.9	18.7	22.3	25.0	27.6
30	14.7	21.2	25.4	30.8	34.8	38.8
60	17.9	25.0	29.7	35.7	40.1	44.5
120	21.7	29.0	33.8	39.9	44.4	48.9
360	29.1	38.4	44.6	52.5	58.3	64.1
720	35.2	48.0	56.5	67.3	75.3	83.2
1,440	43.8	62.6	75.0	90.7	102.3	113.9

Note:
Data Source: EC 2012

Table 8: North Bay A - Statistics (millimetre rainfall)

Duration (minutes)	Return Period (years)					
	2	5	10	25	50	100
5	6.8	9.0	10.5	12.3	13.7	15.1
10	9.8	13.4	15.8	18.8	21.1	23.3
15	11.6	15.9	18.7	22.3	25.0	27.6
30	14.7	21.2	25.4	30.8	34.8	38.8
60	17.9	25.0	29.7	35.7	40.1	44.5
120	21.7	29.0	33.8	39.9	44.4	48.9
360	29.1	38.4	44.6	52.5	58.3	64.1
720	35.2	48.0	56.5	67.3	75.3	83.2
1,440	43.8	62.6	75.0	90.7	102.3	113.9

Note:
Data Source: EC 2012



5.2 4.2. Regional Hydrology

5.2.1 4.2.1 Literature Review

Mean annual runoff for the region is in the range of 300 mm to 350 mm, with increasing runoff occurring to the northeast and southwest of the Project site (Fisheries and EC 1978). This is within the range of the average annual water surplus indicated in Section 4.1.1. The average annual precipitation for the region is in the range of 800 mm to 900 mm (Section 4.1.1). Over long periods of time, runoff subtracted from precipitation provides an estimate of total water lost to the atmosphere through evapotranspiration (ET) and to deep groundwater resources. Based on these values, annual water losses are in the range of 450 mm to 600 mm, which agrees with regional estimates of lake evaporation and evapotranspiration (Section 4.1.1).

Groundwater contribution to streamflow for the region has been estimated to have contributed less than 20% of total streamflow (MNR 1984). This provides an indication of the dominance of surface water flow systems in the overall transport of water into these watersheds. Groundwater recharge can be considered small in comparison to ET losses.

5.2.2 Mattagami River Water Management Plan

The Mattagami River Water Management Plan (MRWMP), produced by MNR et al (2006) was developed to incorporate the concerns of various stakeholders for the uses of the Mattagami River system, which extends approximately 420 km from the headwaters of Mesomikenda Lake to the Mattagami River confluence with the Moose River.

The MRWMP mandates operating levels for all 18 dams and generating stations located in the Mattagami River watershed. The operational procedures for the two dams located in close proximity to the Project site; the Mesomikenda Lake Dam (owned by OPG) and the Minisinakwa Lake Dam (owned by MNR) are detailed here.

5.2.3 Mesomikenda Lake Dam

The normal operating ranges for the Mesomikenda Lake Dam are summarized in Table 9. The key drawdown period is during winter in order to reduce spring runoff peaks. Lake level is to be subsequently raised from the target winter minimum water level to its summer operating level by the time water temperature reaches 5°C (for spring fish spawning protection). This elevation is also to be maintained to July 15th for wildlife (waterfowl nesting) purposes.

Table 9: Mesomikenda Lake Dam - Operating Rules

Normal Operating Range (masl)	Summer Target Operating Range (Victoria Day to Thanksgiving) (masl)	Winter Target Minimum Elevation (masl)
362.30–365.30	364.94–365.30	362.30

Note:
masl – metres above sea level



5.2.4 Minisinakwa Lake Dam

The normal operating water level range for the Minisinakwa Lake Dam is summarized in Table 10. The lake level is to be raised from the target winter minimum water level to its summer operating level by the time water temperature reaches 5°C (for fish spawning purposes).

Table 10: Minisinakwa Lake Dam - Operating Rules

Normal Operating Range (masl)	Summer Target Operating Level (Victoria Day to Thanksgiving) (masl)	Winter Target Minimum Elevation (masl)
347.78–349.00	348.40	347.78

Note:
masl – metres above sea level

5.2.5 Mattagami River Source Water Protection Plan

The Mattagami River Conservation Authority (MRCA) has completed a proposed Source Water Protection Plan intended to minimize and mitigate potential threats to the drinking water supply for the City of Timmins. The Mattagami River serves as the source of municipal water in Timmins, and future development in the Mattagami River watershed is addressed through policies developed as a part of this Source Water Protection Plan (Mattagami Region Source Protection Committee 2012).

The Project site is located 110 km upstream of the Timmins municipal water intake, and is within the area referred to as the Intake Protection Zone (IPZ) 3. As summarized by the Mattagami Region Source Protection Committee (2012), the IPZ3 is defined by a 120 m buffer around each lake and river located in the contributing watersheds upstream of the municipal water intake in Timmins. Policies proposed for mining developments in the IPZ3 include a recommendation that long-term water management planning is addressed through the development of Closure Plans.

5.2.6 Regional Hydrology Monitoring Locations

Regional discharge and water level data for the available hydrological monitoring locations are displayed in Figure 6. Water level has been normalized to an arbitrary datum (100.0 m) to allow for a relative comparison between sites. The contrasting temporal trends in these hydrological parameters are a result of regulation at the Mesomikenda and Minisinakwa Lake dams. Mesomikenda Lake displays three distinct peak flow periods that coincide with dam operating rules (Table 9). In contrast, a single spring runoff peak flow is typical for the unregulated rivers such as the Mollie River gauging station (Figure 6).

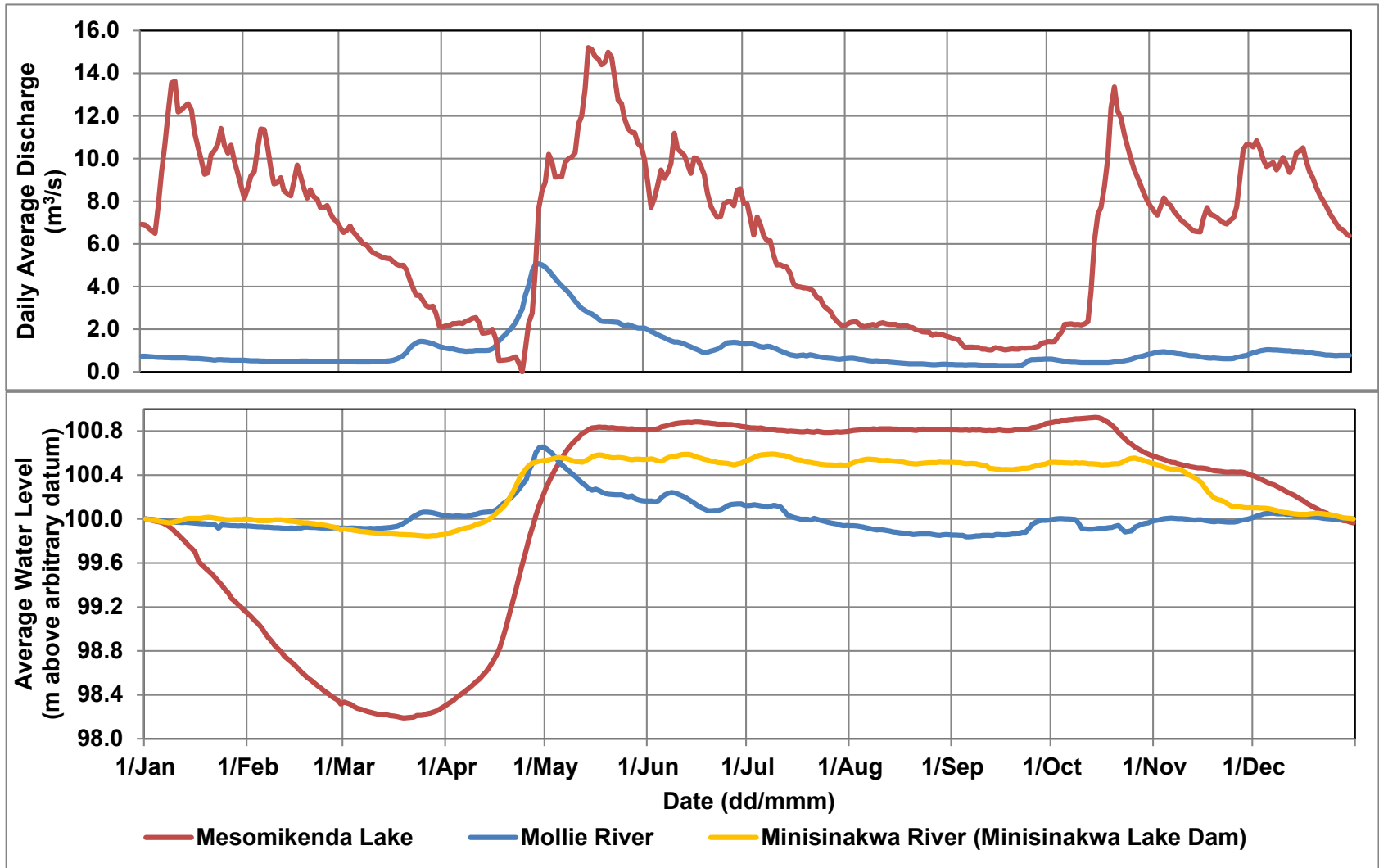



5.3 Local Meteorology

Local meteorology has been compiled for the Project site from the meteorological station for the period May 18, 2012 to July 31, 2013. The meteorology for the four regional stations was also compiled for the overlapping period of record for the Project site in Table 13. A review of these records and input from on-site IAMGOLD personnel identified two periods, December 12, 2012 to March 31, 2013 and June 1, 2013 to August 13, 2013, where the precipitation collector on the Project site was not functioning correctly due to snow bridging or tipping bucket obstruction.

To estimate a complete precipitation record for the entire study period, on-site precipitation data was combined with data estimated from the regional climate monitoring stations. The inverse distance squared method was used to develop representative on-site data and was selected as it was not dependent on the length of the available data from the Project site (Dingman 1994). This method assigns a weight to each of the regional stations based on the distance of the regional station from the Project site. The results of the on-site gap-filled dataset and the comparison to regional stations are summarized in Table 11.

Table 11: Regional and Local Meteorological Comparison

Location	Overlapping Period of Record	Côte Gold Project Site	Sudbury A	Timmins A	Chapleau A	North Bay A
Average Daily Temperature (°C)	May 18, 2012 – July 31, 2013	5.8	6.6	4.4	4.7	7.3
Total Precipitation (mm)	June 12, 2012 – July 31, 2013 ¹	826.8	961.3	765.2	941.0	1017.9

Note:

°C – degree Celsius

mm - millimetre

¹ Precipitation data not available for Timmins for the period May 18 to June 12, 2012

Daily average temperature for the Project site was compared to the regional stations identified in Section 4.1.2. Figure 7 shows a temporally similar pattern for the Project site and regional stations. For the overlapping period of record (May 18, 2012 to July 31, 2013) the average daily temperature at the Project site was 5.8°C, which is within the range of observed temperatures recorded at the regional climate stations (Table 12) and consistent with the regional long-term climate conditions (Table 4).

Cumulative precipitation at the Project site was compared to the regional stations for the overlapping period of record (June 12, 2012 to July 31, 2013) with the gap-filled precipitation record (Figure 7). Total precipitation received at the Project site over this period was 826.8 mm. This precipitation depth is generally consistent with the regional trends in precipitation (i.e. drier than Sudbury and North Bay, wetter than Timmins). However, Chapleau is generally the driest of the regional locations (Table 4) and received more precipitation than the Project site over this period of record. This is most likely due to at least three rain events that exceeded 30 mm/day (EC 2013) which were not received in Timmins or at the Project site.

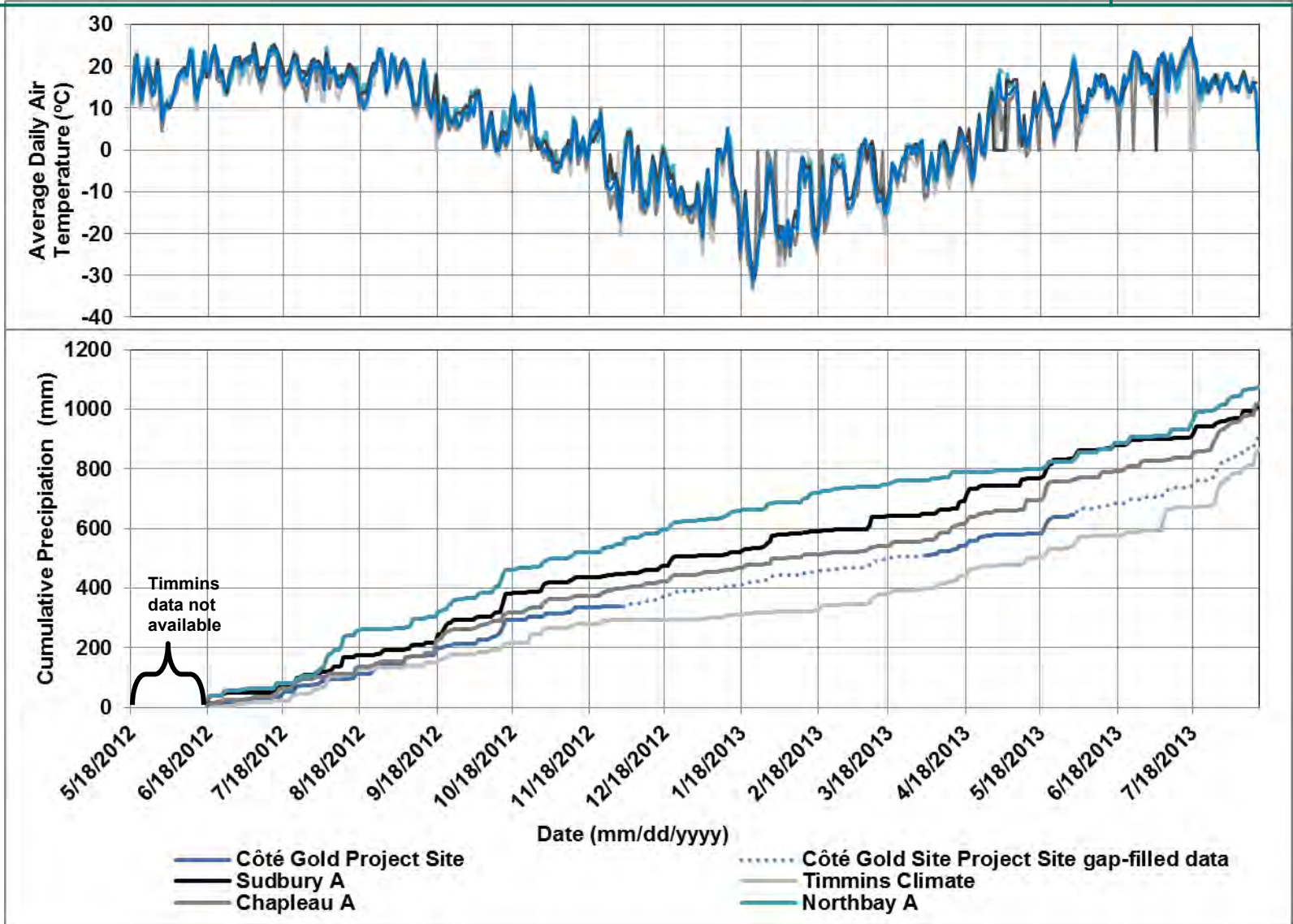



5.4 Local Hydrology

5.5 Local Watersheds

Surface water in the area of the Project site is controlled by topography, geology (bedrock outcrops that promotes lake formation) and the close proximity to the James Bay/Great Lakes watershed (headwater conditions). Watersheds at the Project site form a part of the headwaters of the Mattagami River Watershed.

Two key watersheds drain the Project site; the Mollie River Watershed and the Mesomikenda Lake Watershed (Figure 8). Table 12 summarizes the lake features found within these two watersheds.

Table 12: Lake Feature Summary

Watershed	Name	Surface Area (ha)
Mesomikenda Lake	Bagsverd Lake	215
	Billie Lake	43
	Felix Lake	12
	Little Clam Lake	7
	Mesomikenda Lake ¹	1,705
	Mouse Lake	27
	Neville Lake	108
	Owatawetnes Lake	91
	Pebonishewi Lake	1,186
	Rat Lake	48
	Resound Lake	144
	Schist Lake	403
	Schou Lake	220
	Somme Lake	68
	Trail Lake	11
	Vivian Lakes	16
	Whalsom Lake	368
	Wolf Lake	104
Mollie River	Ash Lake	17
	Attach Lake	5
	Chain Lake	8
	Chester Lake	98
	Clam Lake	80
	Côté Lake	18
	Delaney Lake	27
	Dividing Lake	129
	George Lake	5
	Moore Lake	92
	Ray Lake	3
	Rene Lake	17



HYDROLOGY AND CLIMATE BASELINE

Watershed	Name	Surface Area (ha)
	Sawpeter Lake	4
	Three Duck Lakes ²	201
	Twin Lakes	13
	Weeduck Lake	22

Notes:

ha - hectares

¹ Mesomikenda Lake included due to proximity to Project site and Neville Lake

² Three Duck Lakes area includes Upper, Middle and Lower lake area

Path: Z:\Projects\2013113-1192-0021\GIS\MXDs\Reporting\Hydrology\Figure8_LocalWatershed.mxd

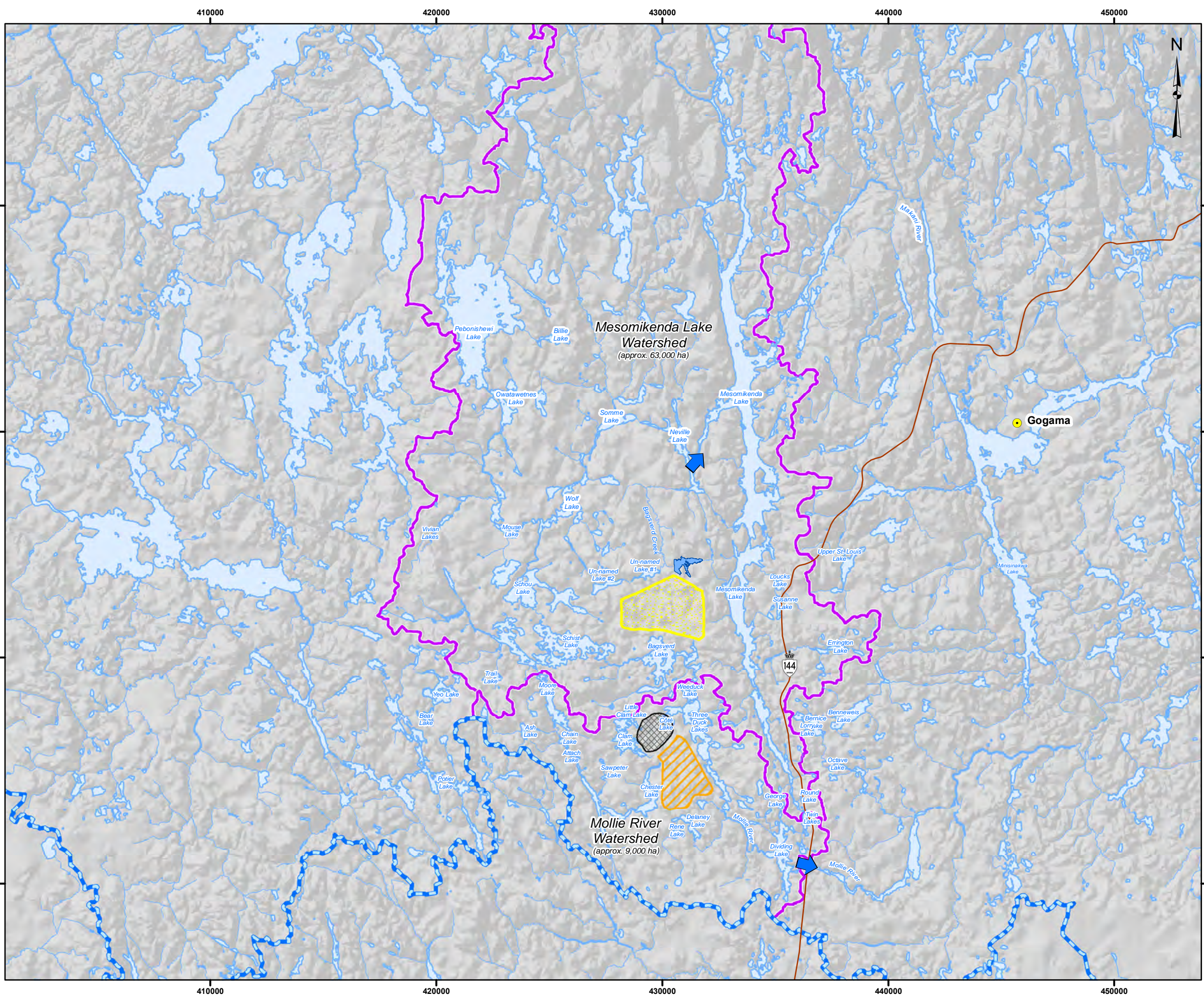

LEGEND

- Populated Places
- Major Road
- Polishing Pond
- Tailings Management Facility (TMF)
- Open Pit
- Mine Rock Area (MRA)
- Arctic/Atlantic Watershed Divide
- Watershed Boundary
- Flow Direction

REFERENCE

Open Pit Shell provided by IAMGOLD, May 2013
 Base Data - MNR NRVIS, CANMAP v2008.4
 Produced by Golder Associates Ltd under licence from
 Ontario Ministry of Natural Resources, © Queens Printer 2013
 Projection: Transverse Mercator Datum: NAD 83 Coordinate System: UTM Zone 17

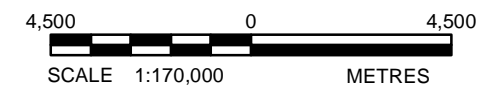

PROJECT		IAMGOLD CÔTÉ GOLD PROJECT	
TITLE			
Local Watershed Divide			
 Golder Associates Sudbury, Ontario	PROJECT No.	13-1192-0021	SCALE AS SHOWN
	DESIGN	RRD Dec. 2012	REV. 0
	CHECK	SK Nov. 2013	FIGURE: 8
	REVIEW	KAB Nov. 2013	



5.5.1 Mollie River Watershed

The Mollie River connects a chain of lakes that discharge through the proposed open pit and mine rock placement areas (Figure 8). The headwaters of the river include Moore Lake, which discharges sequentially through Attach Lake, Chester Lake, Côté Lake and Three Duck Lakes. Outflow from other lakes also contributes to the Mollie River, including Clam Lake (downstream of Chester Lake), Weeduck Lake (upstream of Three Duck Lakes) and smaller headwater features (e.g. Mill Pond, Delaney Lake, Figure 8). The Mollie River discharges to Dividing Lake and east of Highway 144 into Lake Minisinakwa near the town of Gogama. At the 04LA006 WSC streamflow gauging location (Figure 3), the upstream watershed area is approximately 9,000 hectares.

5.5.2 Mesomikenda Lake Watershed

The Mesomikenda Lake watershed (approximately 63,000 ha) drains two tributaries in the vicinity of the Project site via Neville Lake; the Somme River and Bagsverd Creek (Figure 9). The Somme River drains several headwater lakes located to the west, southwest and northwest of the Project site (e.g. Somme Lake; Wolf Lake). Bagsverd Creek headwaters are located at Schist Lake and the creek subsequently flows north through the Project site. Bagsverd Creek receives discharge from Bagsverd Lake and other un-named features that have been given identification codes for the purposes of the study (e.g. Un-named Lake #1 and Un-named Lake #2; Figure 5). Neville Lake discharges to Mesomikenda Lake, which in turn discharges to the Makani River and Minisinakwa Lake upstream of the Mattagami River.

Local watershed areas, defined by the areas upstream of the water quantity monitoring location (Table 3) are displayed in Figure 9 and Figure 10.

Path: Z:\Projects\2013\13-1192-0021\GIS\MXDs\Reporting\Hydrology\Figure9_LocalWatershedSouth.mxd

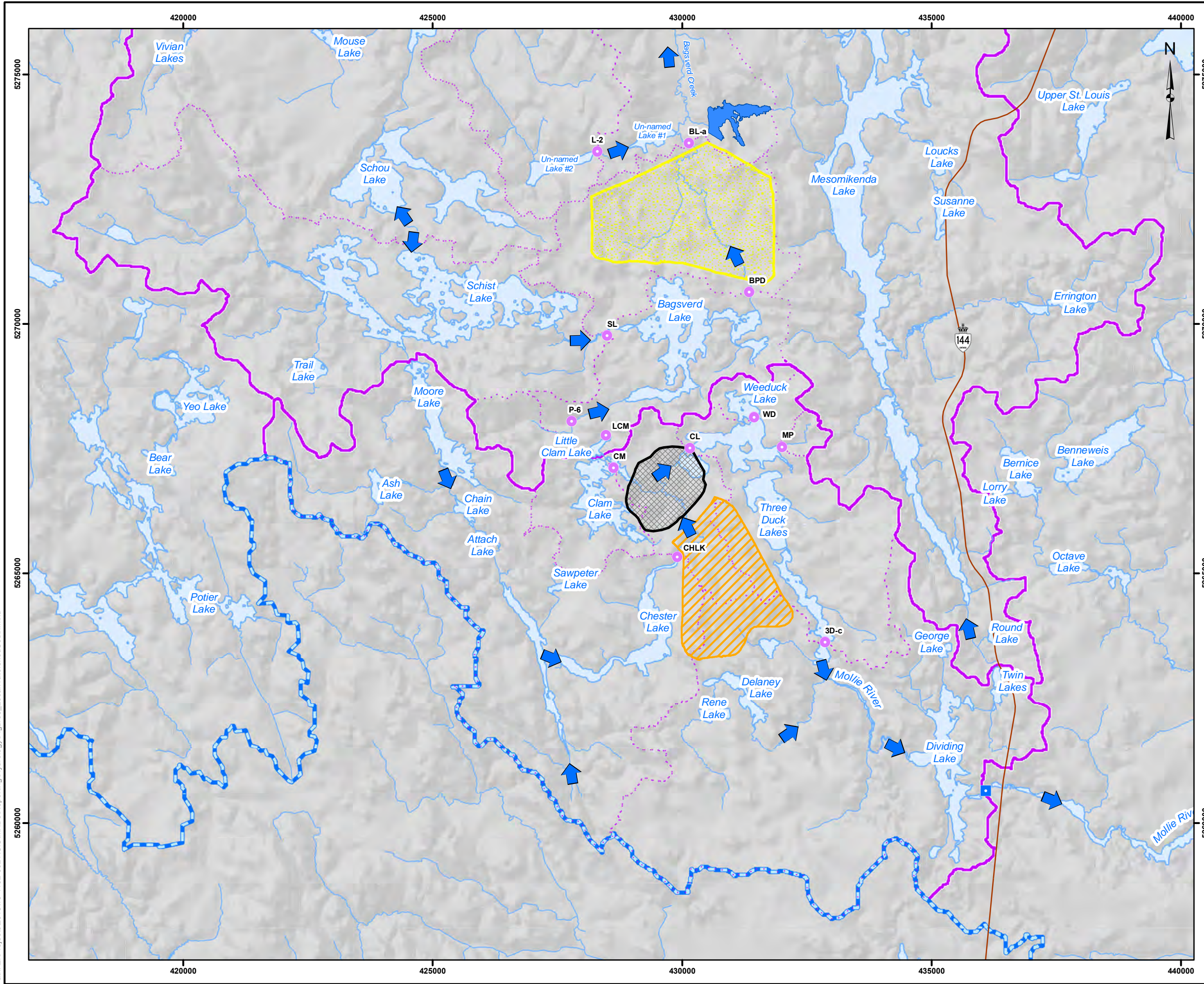

LEGEND

- Major Road
- Local Hydrology Monitoring Station
- Regional Hydrological Monitoring Location
- Polishing Pond
- Mine Rock Area (MRA)
- Open Pit
- Tailings Management Facility (TMF)
- Sub-Watersheds
- Watershed Boundary
- Arctic/Atlantic Watershed Divide

REFERENCE

Open Pit Shell provided by IAMGOLD, May 2013
 Base Data - MNR NRVIS, CANMAP v2008.4
 Produced by Golder Associates Ltd under licence from Ontario Ministry of Natural Resources, © Queens Printer 2013
 Projection: Transverse Mercator Datum: NAD 83 Coordinate System: UTM Zone 17

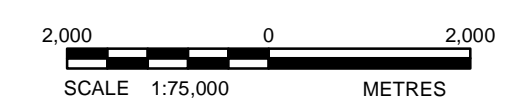

PROJECT		IAMGOLD CÔTÉ GOLD PROJECT	
TITLE		Local Watersheds (Southern Portion)	
<p>Golder Associates Sudbury, Ontario</p>	PROJECT No.	13-1192-0021	SCALE AS SHOWN
	DESIGN	RRD Dec. 2012	REV. 0
	GIS	AL Oct. 2013	FIGURE: 9
	CHECK	SK Nov. 2013	
REVIEW	KAB Nov. 2013		

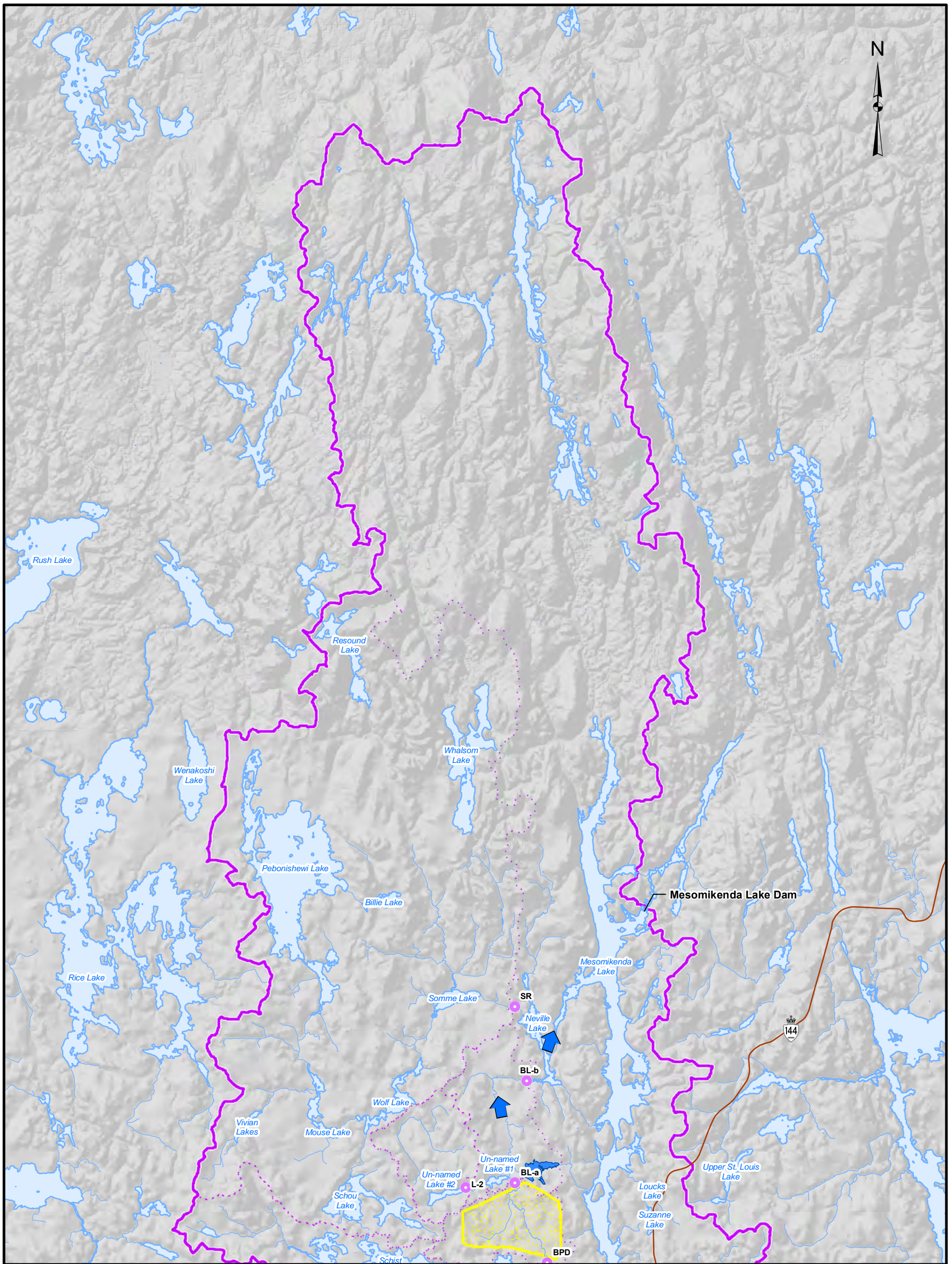



LEGEND

-  Major Road
-  Local Hydrology Monitoring Station
-  Polishing Pond
-  Tailings Management Facility (TMF)
-  Watershed Boundary
-  Sub-Watersheds

REFERENCE

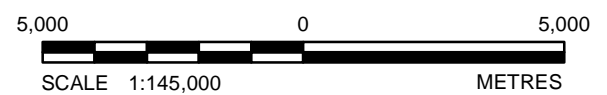
Open Pit Shell provided by IAMGOLD, May 2013
 Base Data - MNR NRVIS, CANMAP v2008.4
 Produced by Golder Associates Ltd under licence from
 Ontario Ministry of Natural Resources, © Queens Printer 2012
 Projection: Transverse Mercator Datum: NAD 83 Coordinate System: UTM Zone 17



PROJECT		 CÔTÉ GOLD PROJECT	
TITLE		Local Watersheds (Northern Portion)	
PROJECT No. 13-1192-0021		SCALE AS SHOWN	REV. 0
DESIGN	RRD	Dec. 2012	FIGURE: 10
GIS	AL	Oct. 2013	
CHECK	SK	Nov. 2013	
REVIEW	KAB	Nov. 2013	
 Golder Associates Sudbury, Ontario			

Z:\Projects\2013\13-1192-0021\GIS\MXDs\Reporting\Hydrology\Figure10_LocalWatershedNorthPortrait.mxd



5.5.3 Local Water Level

Water level responses for automatic recording hydrological stations (Figure 4 and Figure 5) are shown in Appendix A. For the available period of record, water level change ranged from 0.1 m to 1.9 m (Table 13). The highest water levels were recorded during spring months, and were occasionally exacerbated by downstream beaver activity (e.g. BL-a). Water level rise followed extended rain or snowmelt, or, in some cases, was a result of beaver activity downstream of water level sensor installations.

Table 13: Water Level Recordings

Site ID	Station Description	Period of Record (for current study)	Watershed	Maximum Water Level Elevation (masl) ¹	Minimum Water Level Elevation (masl) ¹	Range (m)	Average Water Level Elevation (masl)
BL-b	Bagsverd Creek Outflow	Jul 2012 – Jul 2013	Mesomikenda Lake	369.9	369.3	0.6	369.5
BL-a	Bagsverd Creek at Un-named Lake #2	Mar 2012 – Jul 2013	Mesomikenda Lake	373.9	372.0	1.9 ²	372.6
BPD	Bagsverd Lake Outflow	Mar 2012 – Jul 2013	Mesomikenda Lake	380.4	379.7	0.7	379.9
L-2	Un-named Lake #2 Outflow	Mar 2012 – Jul 2013	Mesomikenda Lake	373.9	373.3	0.6	373.5
SL	Schist Lake Outflow	Mar 2012 – Jul 2013	Mesomikenda Lake	381.0	380.4	0.6	380.5
P-6	West Beaver Pond Outflow	May 2012 – Jul 2013	Mesomikenda Lake	381.7	381.3	0.4	381.5
SR	Somme River Outflow	Mar 2012 – Jul 2013	Mesomikenda Lake	372.8	371.7	1.1	371.9
LCM	Little Clam Lake Outflow	Apr 2012 – Jul 2013	Mesomikenda Lake	388.0	387.5	0.5	387.7
CHLK	Chester Lake Outflow	May 2012 – Jun 2013	Mollie River	385.7	384.6	1.1	384.9
CL	Côté Lake Outflow	Oct 2012 – Jul 2013	Mollie River	381.5	380.6	0.1	380.8
MP	Mill Pond Outflow	Mar 2012 – Jul 2013	Mollie River	381.5	380.7	0.8	380.9
CM	Clam Lake Outflow	Mar 2012 – Jul 2013	Mollie River	386.6	385.9	0.6	386.2
WD	Weeduck Outflow	Mar 2012 – Jul 2013	Mollie River	381.7	381.1	0.6	381.3
3D-C	Three Duck Lakes Outflow	Mar 2012 – June 2013	Mollie River	381.2	380.3	0.9	380.5

Note:

¹ Elevations are based on geodetic surveys completed by L. Labelle Surveys, June and October 2012.

² Influenced by beaver activity downstream of hydrological installation

masl – metres above sea level

m - metres



5.5.4 Local Streamflow

Manual instantaneous streamflow measurements taken for the period March 2012 to July 2013 displayed a wide range of flows for the various waterways on the Project site (Table 14). The greatest discharge measurements occurred at the Somme River Outflow (SR; 8,462 litres per second [L/s]), the Bagsverd Creek Outflow (BL-b; 3,610 L/s), and the Three Duck Lakes Outflow (3D-C; 2,530 L/s), each of which were observed during the spring freshet.

The observed discharge conditions ranged seasonally by up to two orders of magnitude, and up to three orders of magnitude between sites (Table 14). For example, observed discharge from Côté Lake ranged from approximately 40 L/s to approximately 1,300 L/s, and observed discharge was less than 5 L/s at the Clam Lake and Little Clam Lake Outflow.

Table 14: Streamflow Measurements

Site ID	Station Description	Period of Record (for current study)	Watershed	Number of Discharge Measurements	Maximum (L/s)	Minimum (L/s)	Average (L/s)
BL-b	Bagsverd Creek Outflow	Jul 2012 – Jul 2013	Mesomikenda Lake	10	3,610	190	1,101
BL-a	Bagsverd Creek at Un-named Lake #2	Mar 2012 – Jul 2013	Mesomikenda Lake	4	1,660	300	740
BPD	Bagsverd Lake Outflow	Mar 2012 – Jul 2013	Mesomikenda Lake	5	1,310	10	480
L-2	Un-named Lake #2 Outflow	Mar 2012 – Jul 2013	Mesomikenda Lake	6	180	<1	70
SL	Schist Lake Outflow	Mar 2012 – Jul 2013	Mesomikenda Lake	11	820	120	380
P-6	West Beaver Pond Outflow	May 2012 – Jul 2013	Mesomikenda Lake	7	210	3	50
SR	Somme River Outflow	Mar 2012 – Jul 2013	Mesomikenda Lake	7	8,462	872	3,532
LCM	Little Clam Lake Outflow	Apr 2012 – Jul 2013	Mesomikenda Lake	6	4	0	1
CHLK	Chester Lake Outflow	May 2012 – Jun 2013	Mollie River	4	160	50	100
CL	Côté Lake Outflow	Oct 2012 – Jul 2013	Mollie River	4	1,282	43	537
MP	Mill Pond Outflow	Mar 2012 – Jul 2013	Mollie River	6	150	20	70
CM	Clam Lake Outflow	Mar 2012 – Jul 2013	Mollie River	1	3	3	3
WD	Weeduck Outflow	Mar 2012 – Jul 2013	Mollie River	0 ²	n/a	n/a	n/a
3D-C	Three Duck Lakes Outflow	Mar 2012 – June 2013	Mollie River	9	2,530	10	640

Notes:

L/s – litres per second

¹ Station initiated when new culverts were installed in late October 2012.

² Culverts are submerged and blocked, flow is assumed to be primarily seepage across road embankment



Application of the rating curves to the automatic water level measurements also provided an indication of the dominance of spring freshet flows to the annual hydrograph of the monitored waterways (Appendix A). Across the Project site, runoff response to snowmelt was rapid and the slopes of the rising and falling limbs of the hydrographs were similar (Appendix A). Although there is increased uncertainty in the absolute magnitude of peak discharge, spring freshet represented a key period of water transport and rainfall/runoff responses were much more dampened during the remainder of the year. Hydrographs for the period corresponding to automatic water level data are displayed in Appendix A. Stations most affected by beaver activity were typically those with less upstream drainage area and will require ongoing monitoring to refine and develop the rating curves (Appendix A).

6.0 SUMMARY AND CONCLUSIONS

Located in the Boreal Shield ecozone of Ontario, the Project site is characterized by long, cold winters and short, warm summers with little to no annual water deficit. The Project site is located within the Upper Mattagami River Watershed, which drains northward through the City of Timmins and ultimately to James Bay. Surface water flows at the Project site are controlled by a number of lakes and creeks that flow to the Mollie River and Mesomikenda Lake prior to discharging to Minisinakwa Lake and ultimately the Mattagami River. The Mattagami River upstream of the City of Timmins Water Filtration Plant (including the Project site) is within the Intake Protection Zone 3 in the context of the Mattagami River Source Water Protection program.

Regional climate stations maintained by Environment Canada are located in Timmins, Chapleau, North Bay and Sudbury, Ontario. Long-term climate statistics for the period 1981 to 2010 describe annual total precipitation in the range of approximately 800 mm to 1,050 mm, with approximately one-third of this total precipitation falling as snow. Annual average temperatures at these regional sites are in the range of 1.8°C to 4.2°C, with minimum daily average temperatures occurring in January and maximum daily average temperatures occurring in July.

Regional hydrological monitoring stations maintained by Water Survey of Canada are located on the Mollie River (unregulated flow) and at Minisinakwa Lake (regulated flow), as well as by OPG at the Mesomikenda Lake Dam (regulated flow). The regulated flow systems are governed by a Water Management Plan in place for the Mattagami River (MNR 2006).

An on-site meteorological station was established on the Project site in 2012. The on-site meteorological data has been assessed against, and where required supplemented by, other established regional climate monitoring sites.

Surface water discharge and water level at the Project site are currently monitored at 15 hydrological sampling stations selected and installed during 2012. In general, these monitoring locations have been distributed throughout the two main watersheds of the Project site (i.e. the Mollie River watershed and the Mesomikenda Lake watershed).

Automatic water level dataloggers were installed and used in conjunction with instantaneous discharge measurements to develop a characterization of the streamflow regime in the vicinity of the Project site.

The hydrological regime at the Project site shows up to three orders of magnitude of streamflow variability between sites and up to two orders of magnitude within sites, with a strong bias towards the spring runoff period for peak flow, peak water level and total water volume discharged.



Ongoing hydrological and meteorological monitoring will continue to refine the seasonal, annual (temporal) and catchment scale (spatial) variability in surface water regimes at the Project site.

7.0 REFERENCES

- Dingman, S.L. 1994. Physical Hydrology, Second Edition. Waveland Press Inc., Long Grove Illinois.
- Energy, Mines and Resources Canada. 1990. National Atlas of Canada 5th Edition, Canada Climatic Regions Thornthwaite Classification, Moisture Regions, Map MCR4096 and Thermal Efficiency Regions MCR 4155F.
- Environment Canada. 2013. Government of Canada – Climate. Available online at http://climate.weather.gc.ca/index_e.html. Accessed October 2013.
- Environment Canada. 2012. IDF Files. Available online at ftp://ftp.tor.ec.gc.ca/Pub/Engineering_Climate_Dataset/IDF/. Accessed November 2012.
- Fisheries and Environment Canada. 1978. Hydrological Atlas of Canada.
- Mattagami Region Source Protection Committee. 2012. Proposed Source Protection Plan for the Mattagami Region Source Protection Area.
- Natural Resources Canada. 2012. The Atlas of Canada. Available online at <http://atlas.nrcan.gc.ca/auth/english/index.html>. Accessed November 2012.
- Ontario Ministry of the Environment. 1999. Provincial Water Quality Objectives.
- Ontario Ministry of Natural Resources, Tembec Industries, Beaver Power Corporation and Ontario Power Generation Inc. 2006. Mattagami River Water Management Plan.
- Ontario Ministry of Natural Resources. 1984. Water Quantity Resources of Ontario. MNR PUB 5932.
- Roed, M.A. and Hallett, D.R. 1979. Northern Ontario Engineering Geology Terrain Study. Data Base Map, Gogama. Ontario Geological Survey, Map 5019, Scale 1:100,000.
- Water Survey of Canada. 2012. Archived Hydrometric Data. Available online at <http://www.wsc.ec.gc.ca/applications/H2O/index-eng.cfm>, accessed November 2012.



Report Signature Page

GOLDER ASSOCIATES LTD.

Stephen Kaufman, M.Sc.
Hydrologist

John Petrie, P. Geo.
Principal/Hydrogeologist

SF/SK/JMP/KMM/lis

Golder, Golder Associates and the GA globe design are trademarks of Golder Associates Corporation.

m:\active\2013\1190 sudbury\1192\13-1192-0021 iamgold cote gold project timmins\2. hydrology and climate\reporting\baseline report\13-1192-0021r rpt 14oct15 revised iamgold hydrology baseline.docx



APPENDIX A

Hydrological Monitoring Location Details



Upstream



Downstream

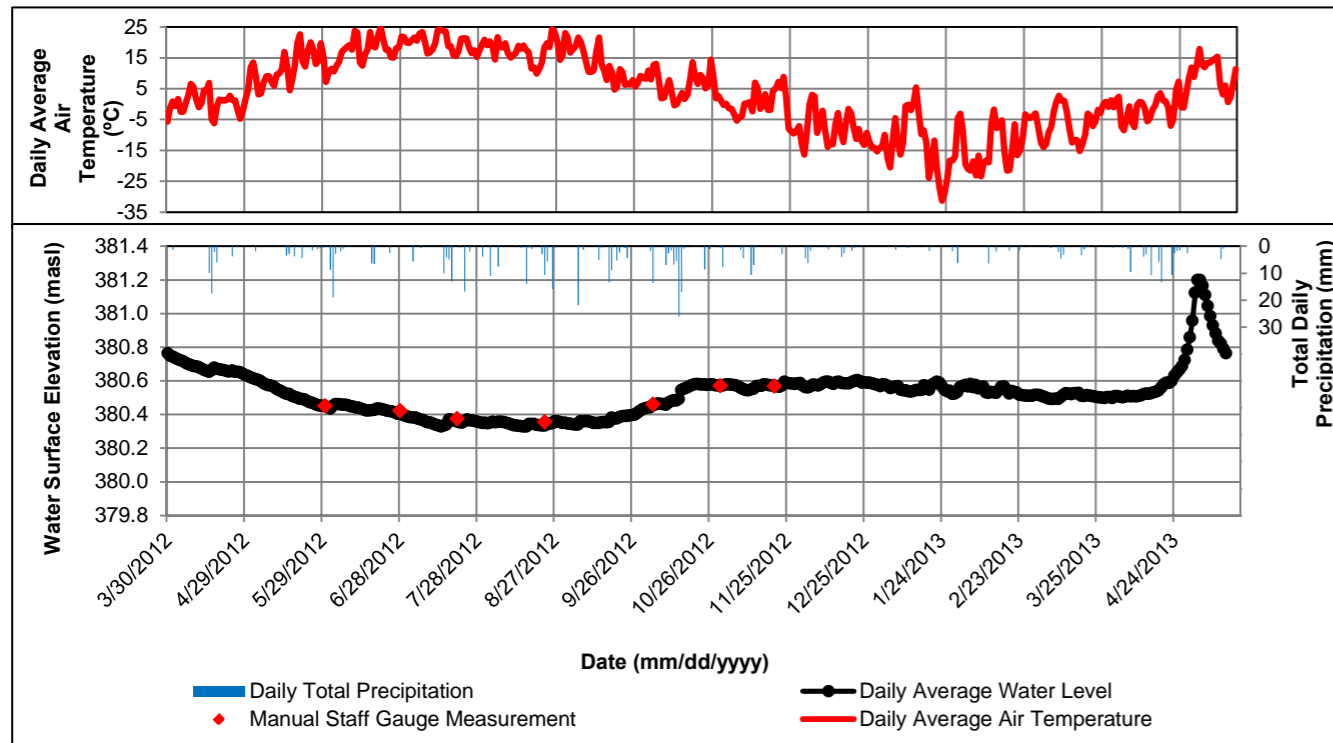
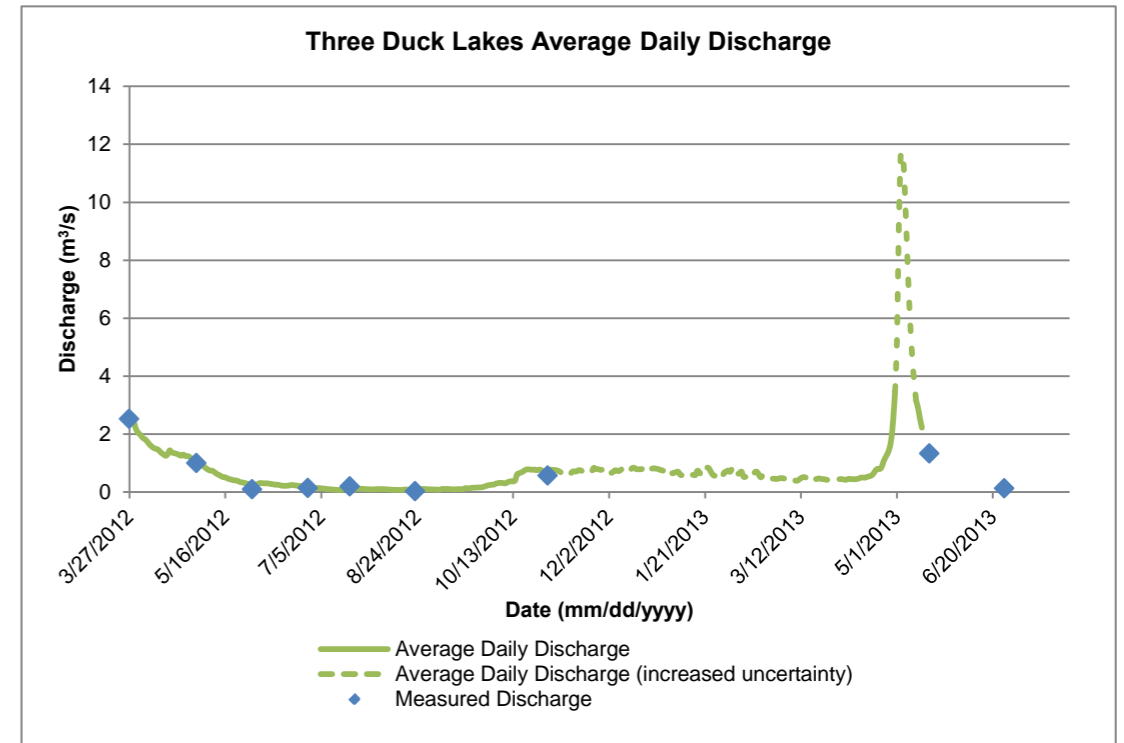

Date	Discharge (m³/s)	Water Surface Elevation (masl)
27-Mar-12	2.53	380.79
30-May-12	0.09	380.45
28-Jun-12	0.14	380.42
20-Jul-12	0.19	380.38
23-Aug-12	0.02	380.36
26-Sep-12	n/a*	380.41
31-Oct-12	0.56	380.58
20-Nov-12	n/a*	380.57
18-May-13	1.33	380.60
26-Jun-13	0.13	380.48

*no measurement taken

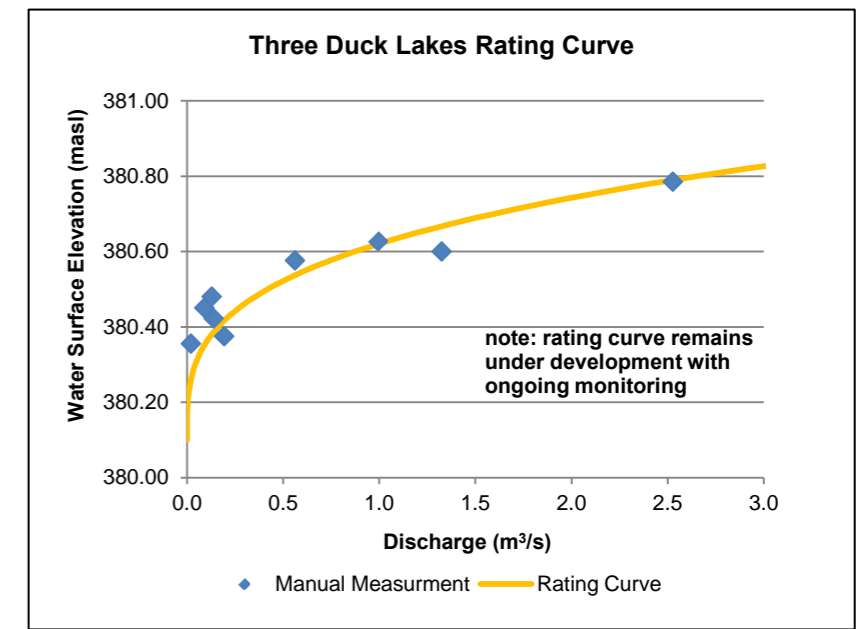

Watercourse Name:	Three Duck Lakes	Station Description	Located in the narrows of the south (lower) basin of Three Duck Lakes. The narrows consist of a channel approximately 6 m in width confined by steep bed rock cliffs. The channel bed consists of medium to coarse cobble. A beaver dam approximately 20 cm in height is located 360 m south of the flow monitoring location at the lake outlet. This dam provides some amount of control on the water levels and discharge from Three Duck Lakes. Along with flow over the crest of the dam, seepage through the structure has been observed.	
UTM Coordinates:	432866.50 E, 5263621.20 N			
Staff Gauge Elevation:	380.55 masl (top of gauge)			
		Equipment Installed	Staff gauge located on the east cliff face of the narrows. The level logger is located on the channel bed. The flow measurements were taken approximately 30 m downstream of the staff gauge.	
PROJECT:	13-1192-0021(1000/1020)	DATE:	Nov-13	Three Duck Lakes (3D-C) Flow Monitoring Station IAMGOLD Côté Gold SHEET 1



Upstream



Downstream

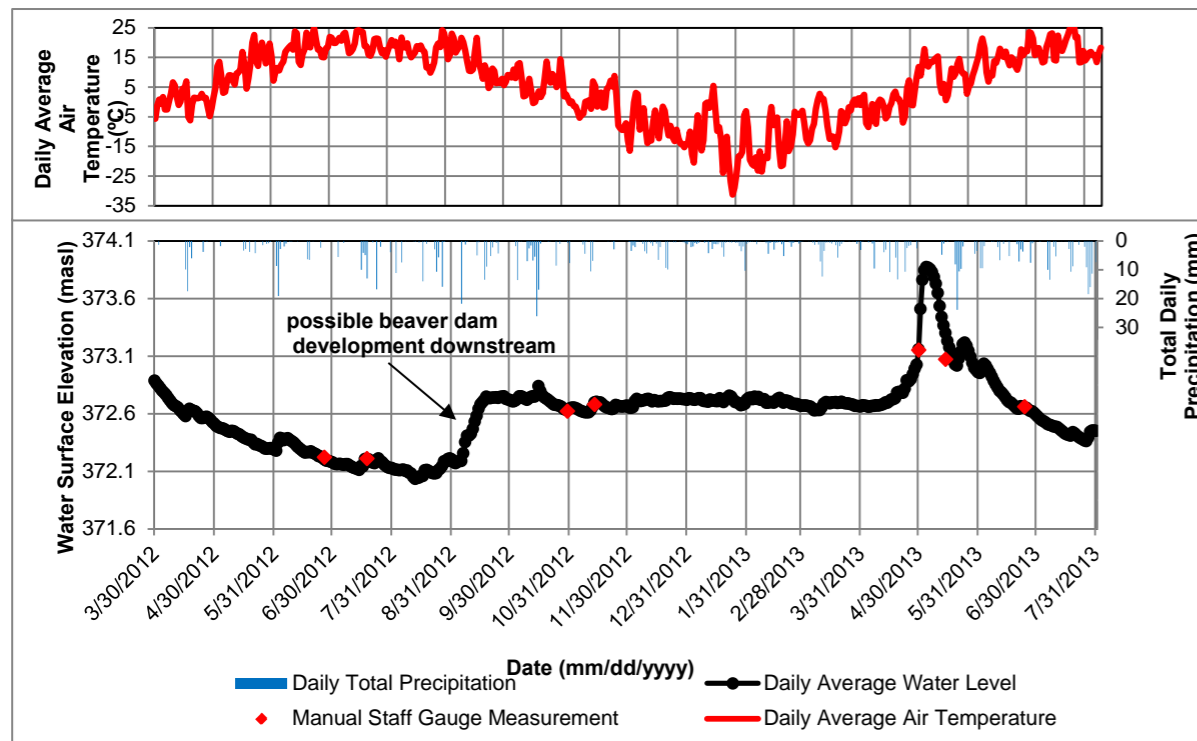
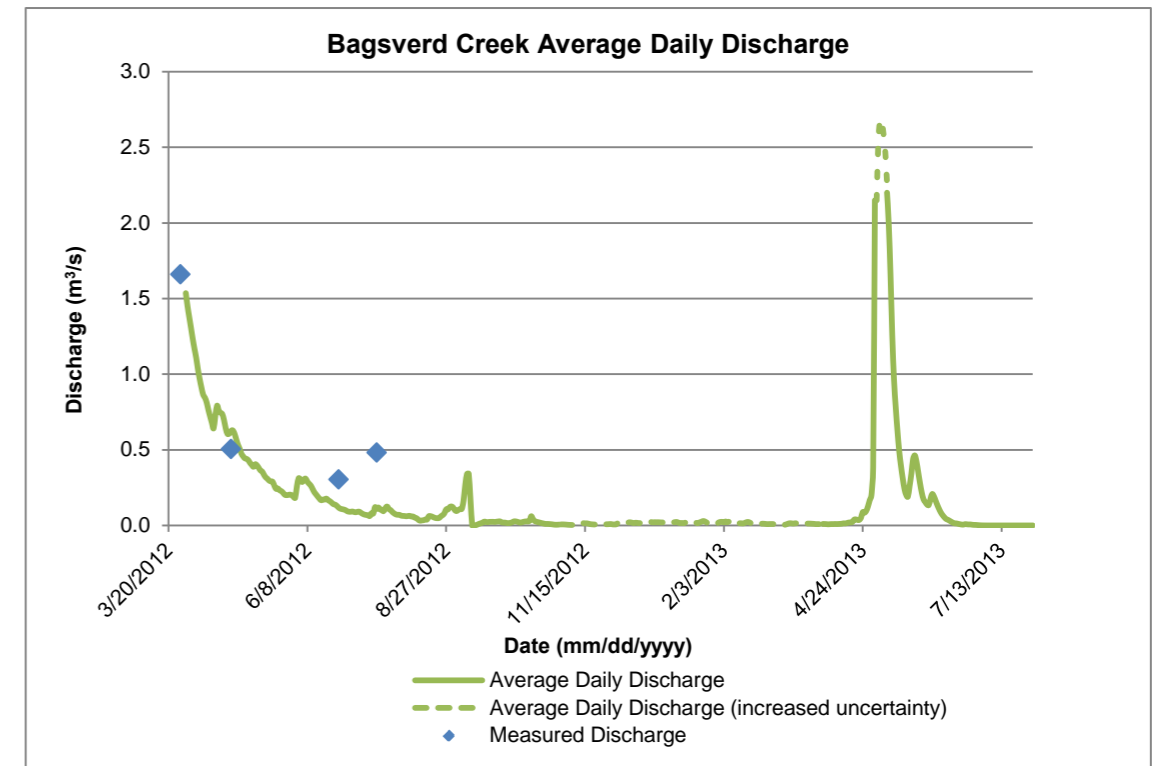

Date	Discharge (m³/s)	Water Surface Elevation (masl)	Comments
27-Mar-12	1.66	372.59	
25-Apr-12	0.51	372.23	
26-Jun-12	0.30	372.22	Beaver dam
18-Jul-12	0.48	372.21	
11-Oct-12	survey	0.00	
30-Oct-12	n/a*	372.62	
13-Nov-12	n/a*	372.68	
19-Dec-12	n/a*	372.72	
30-Apr-13	n/a*	373.15	ice cover
14-May-13	n/a*	373.07	
24-Jun-13	n/a*	372.66	

*no measurement taken

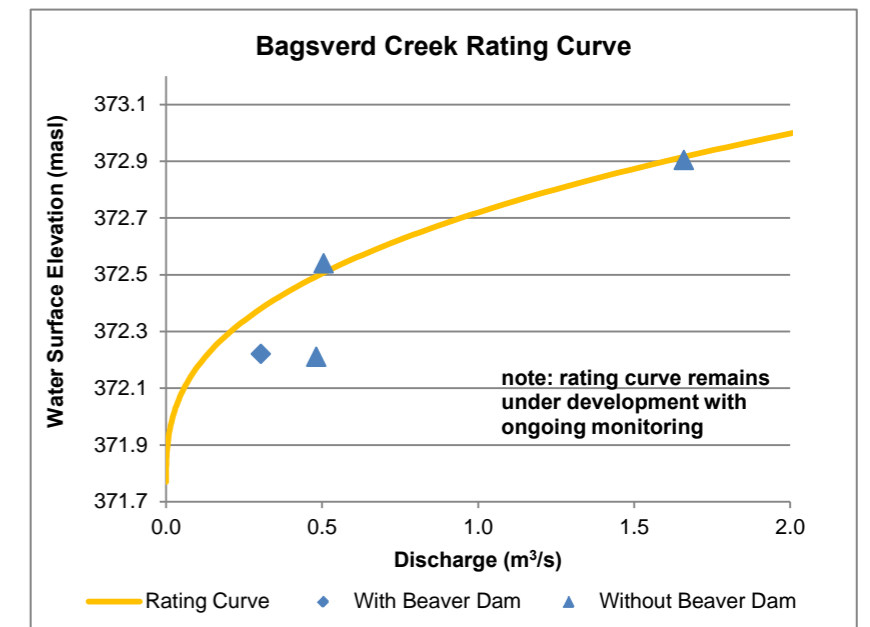

Watercourse Name:	Bagsverd Creek	Station Description	Monitoring location BL-a is located at a gravel road crossing of Bagsverd Creek. This station is upstream of the BL-b watershed. Three CSP culverts with approximate diameters of 1.2 m provide flow conveyance across this road. The culverts are in poor condition and have been partially obstructed with beaver debris. The area surrounding the station is heavily forested. The creek is wide and slow moving at the location.
UTM Coordinates:	430136 E, 5273627 N		
Staff Gauge Elevation:	373.12 masl (top of gauge)		
		Equipment Installed	The staff gauge and logger are located upstream of the crossing, near the culvert closest to the right bank. The level logger was installed on March 30, 2012. Flow measurements were taken at the culvert outlets.
PROJECT:	13-1192-0021(1000/1020)	DATE:	Nov-13

Bagsverd Creek (BL-a) Flow Monitoring Station

IAMGOLD Côté Gold

SHEET 2



Upstream



Downstream

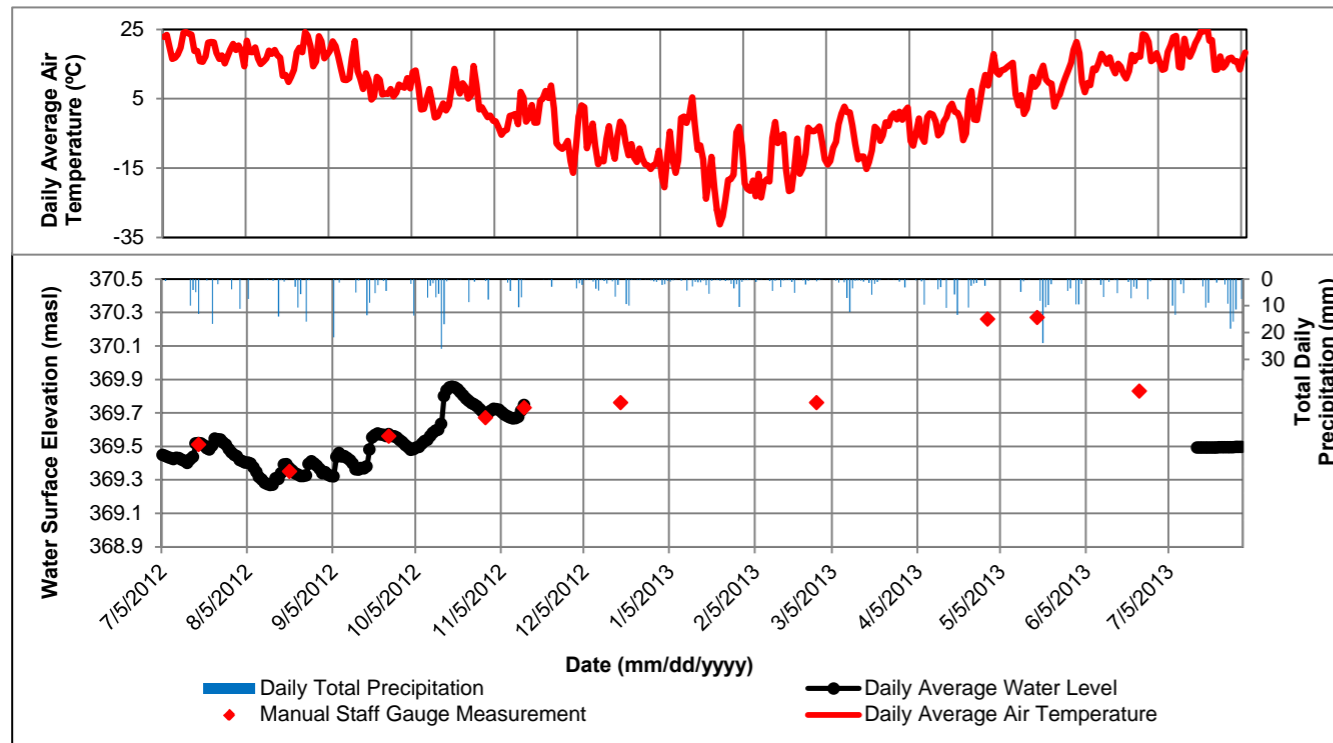
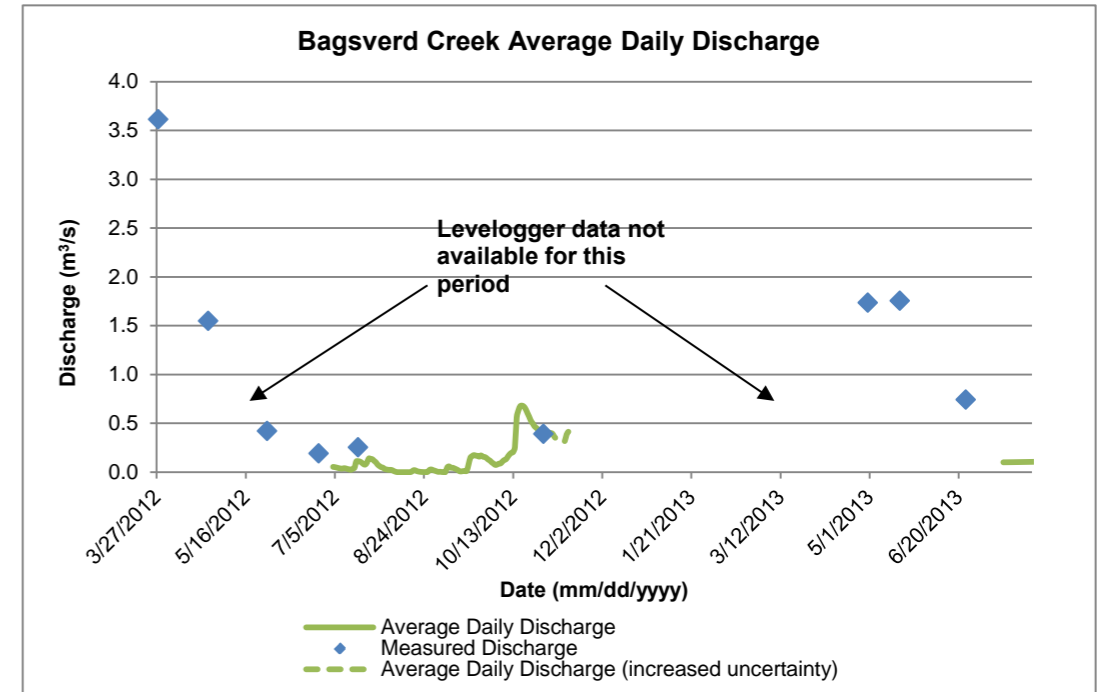

Date	Discharge (m³/s)	Water Surface Elevation (masl)
28-Mar-12	3.61	n/a*
25-Apr-12	1.55	n/a*
28-May-12	0.42	n/a*
26-Jun-12	0.19	n/a*
18-Jul-12	0.25	369.51
20-Aug-12	n/a*	369.35
25-Sep-12	n/a*	369.56
30-Oct-12	0.39	369.67
13-Nov-12	n/a*	369.73
18-Dec-12	n/a*	369.76
27-Feb-13	0.35	369.76
30-Apr-13	1.74	370.26
18-May-13	1.76	370.27
24-Jun-13	0.74	369.83

*no measurement taken

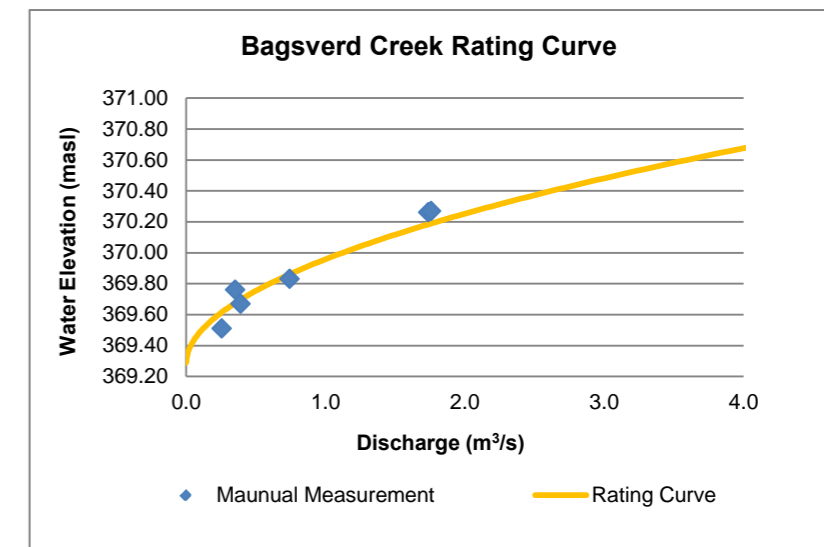

Watercourse Name:	Bagsverd Creek	Station Description	Located at a gravel road crossing of bagsverd Creek in the northern portion of the study area. Three CSP culverts of 1.4, 1.6, and 1.2 m diameters provide flow conveyance across the road. Neville Lake is downstream of this monitoring location. The area surrounding the station is heavily forested. The creek bed is characterised by course cobbles around the crossing with a wide grassed overbanked area. A beaver dam is located approximately 100 m downstream of this station.
UTM Coordinates:	430561.04 E, 5277423.56 N		
Staff Gauge Elevation:	370.28 masl (top of gauge)		
		Equipment Installed	The level logger was installed July 2012. The staff gauge and logger are affixed to the centre culvert. Flow measurements were taken at the culvert outlets. Datalogger installation was vandalised in fall 2012 and replaced in summer 2013.
PROJECT:	13-1192-0021(1000/1020)	DATE:	13-Nov

Bagsverd Creek (BL-b) Flow Monitoring Station

IAMGOLD Côté Gold

SHEET 3



Upstream



Downstream

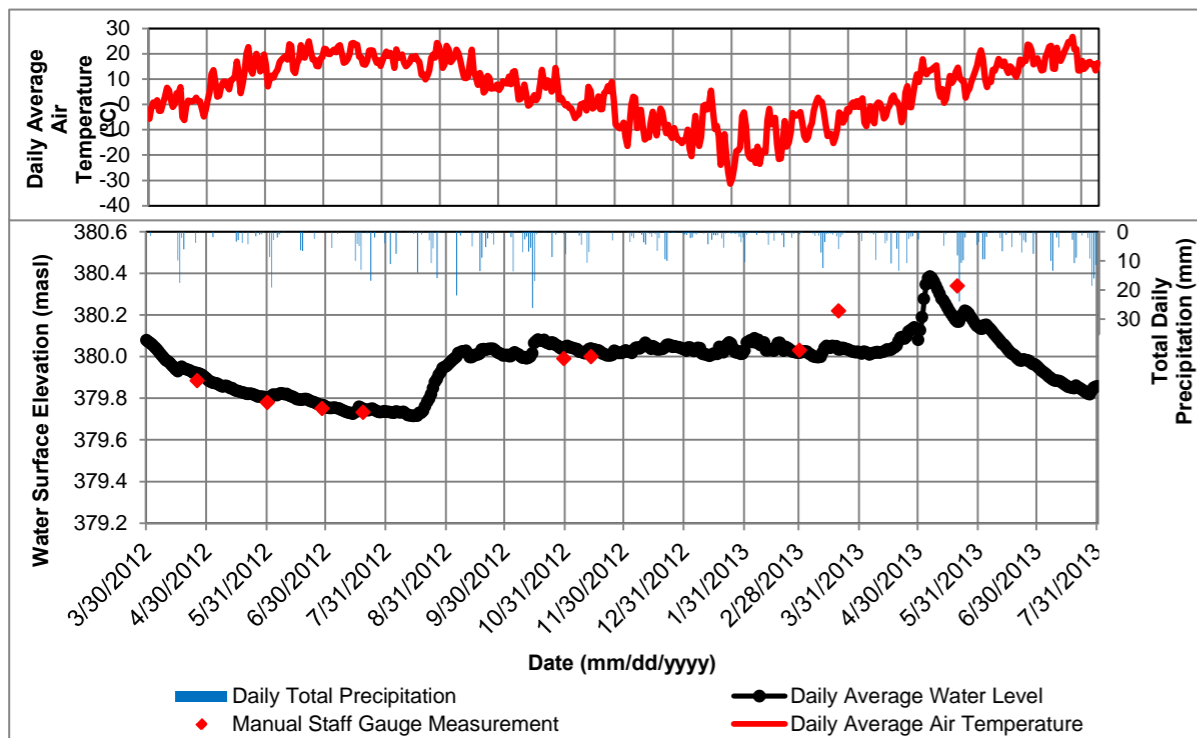
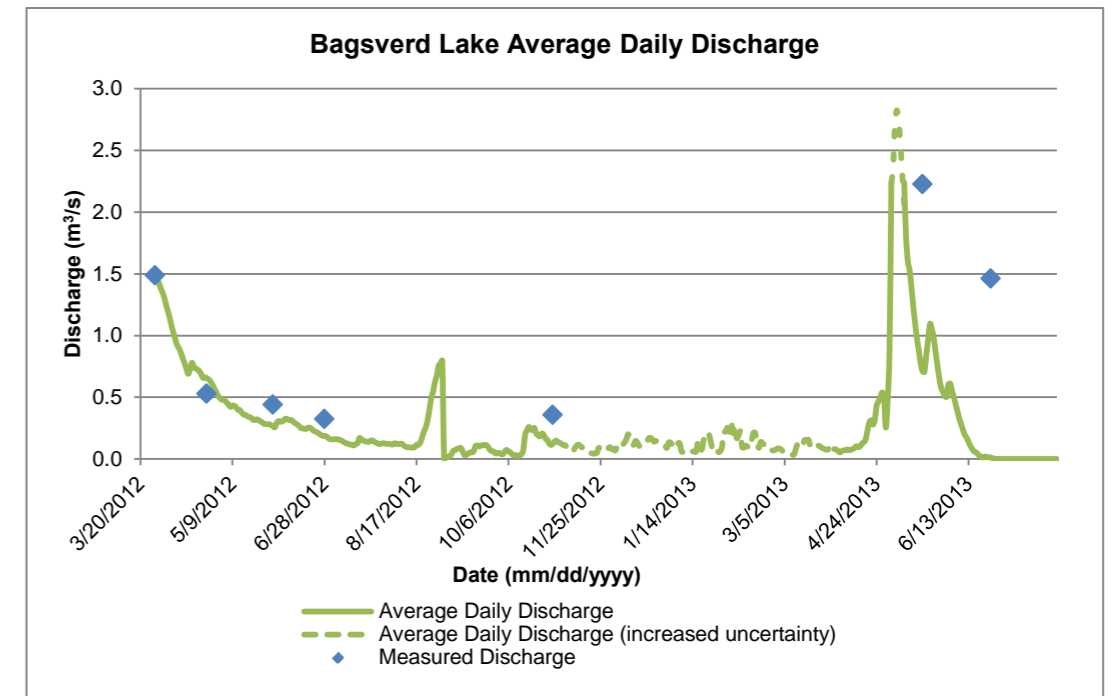

Date	Discharge (m³/s)	Water Surface Elevation (masl)	Comments
28-Mar-12	1.49	380.08	
25-Apr-12	0.53	379.92	
31-May-12	0.44	379.81	
28-Jun-12	0.32	379.78	
19-Jul-12	n/a*	379.76	
22-Aug-12	n/a*	379.8	
25-Sep-12	n/a*	380.03	
30-Oct-12	0.36	380.02	Beaver dam
18-Dec-12	n/a*	380.04	
13-Nov-12	n/a*	380.03	Beaver dam
27-Feb-12	n/a*	380.03	
19-Mar-12	n/a*	380.22	
19-May-13	2.23	380.34	Beaver dam
25-Jun-13	1.46	380.34	Beaver dam

*no measurement taken

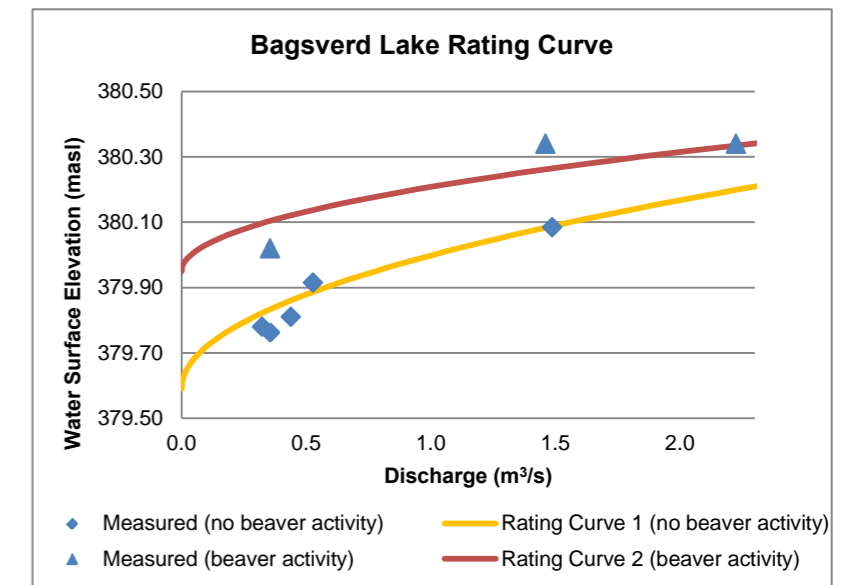

Watercourse Name:	Bagsverd Creek at Bagsverd Lake	Station Description	Located at a rock outcrop crossing downstream of Bagsverd Lake and upstream of the BL-a monitoring location. The area surrounding the station is heavily forested. The creek bed is characterised by bedrock with dense vegetation along the overbank areas. A beaver dam built at the crest of the rock outcrop has influenced water levels at the location.	
UTM Coordinates:	431342.92 E, 5270638.76 N			
Staff Gauge Elevation:	380.43 masl (top of gauge)			
		Equipment Installed	The level logger was installed in March 2012. The staff gauge and logger are approximately 5 m upstream of the ridge. Flow measurements were taken on the bedrock channel downstream of the beaver dam.	
PROJECT:	13-1192-0021(1000/1020)	DATE:	Nov-13	Bagsverd Lake (BPD) Flow Monitoring Station
			IAMGOLD Côte Gold	SHEET 4



Upstream



Downstream

note: photo taken spring 2012, prior to culvert upgrades

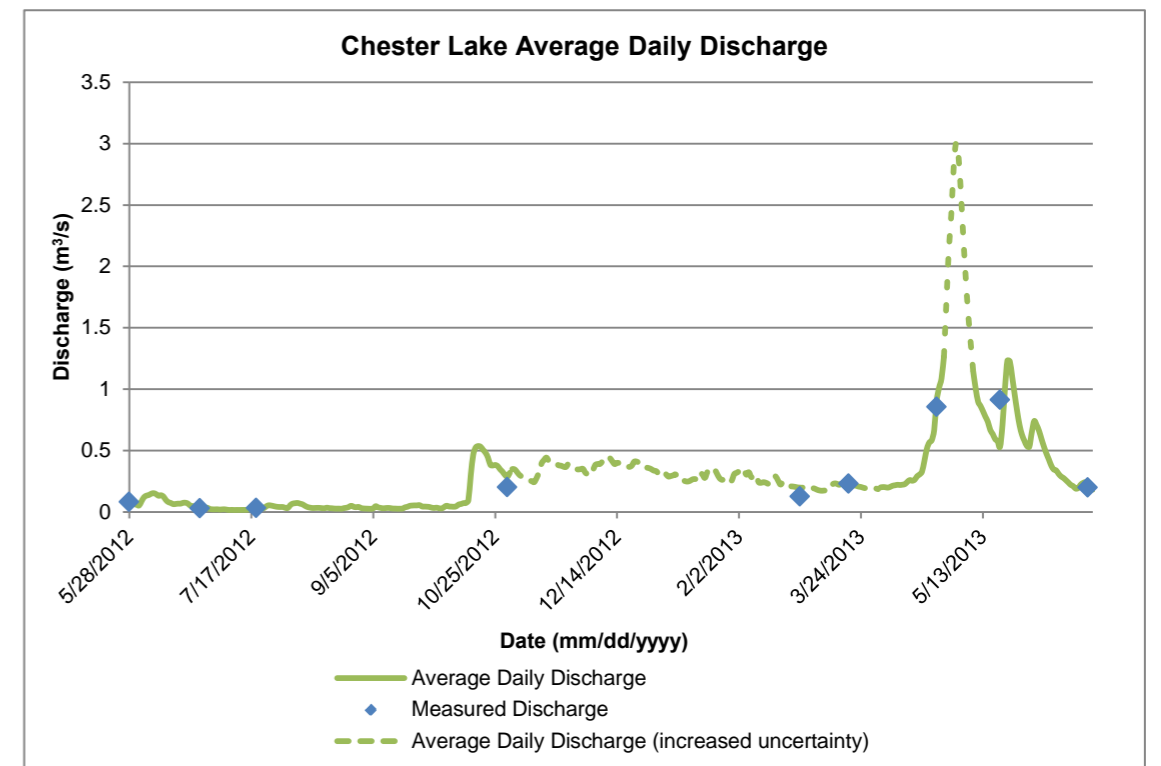
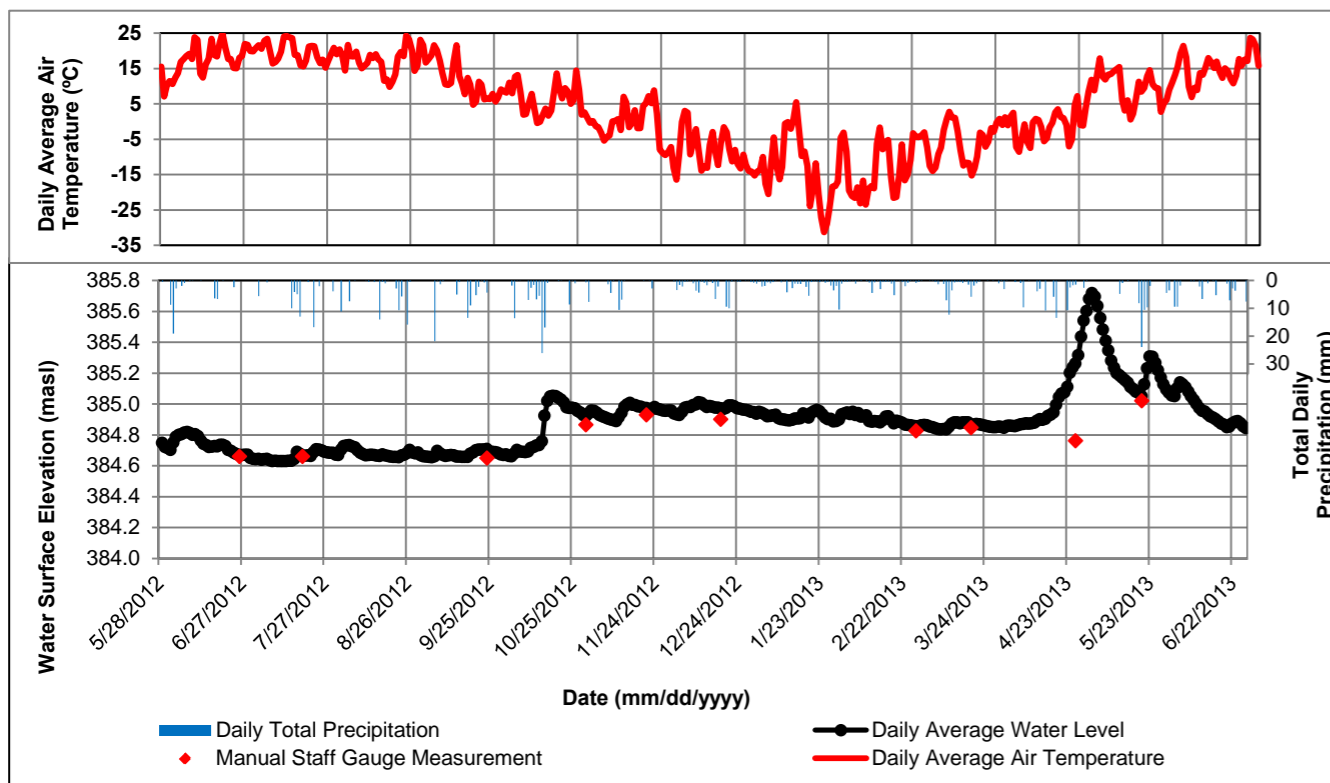

Date	Discharge (m³/s)	Water Surface Elevation (masl)
28-May-12	0.08	384.74
26-Jun-12	0.03	384.66
19-Jul-12	0.03	384.66
24-Sep-12	n/a*	384.65
30-Oct-12	0.20	384.87
21-Nov-12	n/a*	384.93
18-Dec-12	n/a*	384.90
27-Feb-13	0.12	384.83
19-Mar-13	0.23	384.85
24-Apr-13	0.86	384.76
20-May-13	0.91	385.02
25-Jun-13	0.20	384.88

* no measurement taken

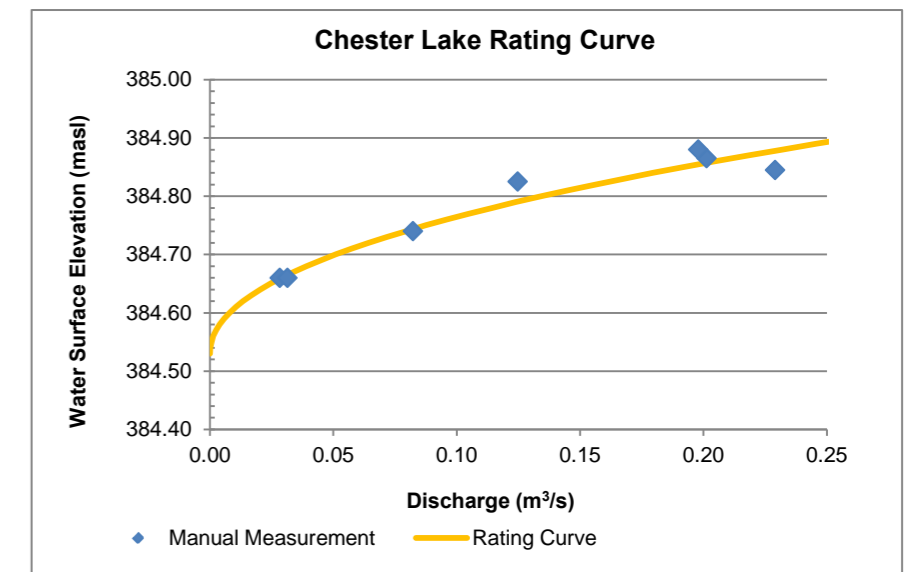

Watercourse Name:	Chester Lake	Station Description Station CHLK is located at a gravel road crossing at the outlet of Chester Lake. This creek system discharges to Côté Lake. Three CSP culverts of 1.8 m diameters provide flow conveyance across the road. These were installed to replace older culverts in September 2012. The area surrounding the station is heavily forested. The area upstream of the crossing consists of a shallow wetland characterised by open water, a sediment bed, and fallen trees around the perimeter. Downstream of the crossing the channel is steep with cobbles and bedrock outcrops			
UTM Coordinates:	429883.37 E, 5265373.29 N				
Staff Gauge Elevation:	385.40 masl (top of gauge)				
		Equipment Installed Originally, a staff gauge and logger were located approximately 30 m downstream of the crossing. This level logger was installed on May 29, 2012. Flow measurements were taken in the channel downstream of the culvert near the original staff gauge. Following improvements to the crossing, a second staff gauge was installed in October 2012. It is affixed to the culvert closest to the right downstream facing bank.			
PROJECT:	13-1192-0021(1000/1020)	DATE:	Nov-13	Chester Lake (CHLK) Flow Monitoring Station	
				IAMGOLD Côté Gold	SHEET 5



Upstream



Downstream

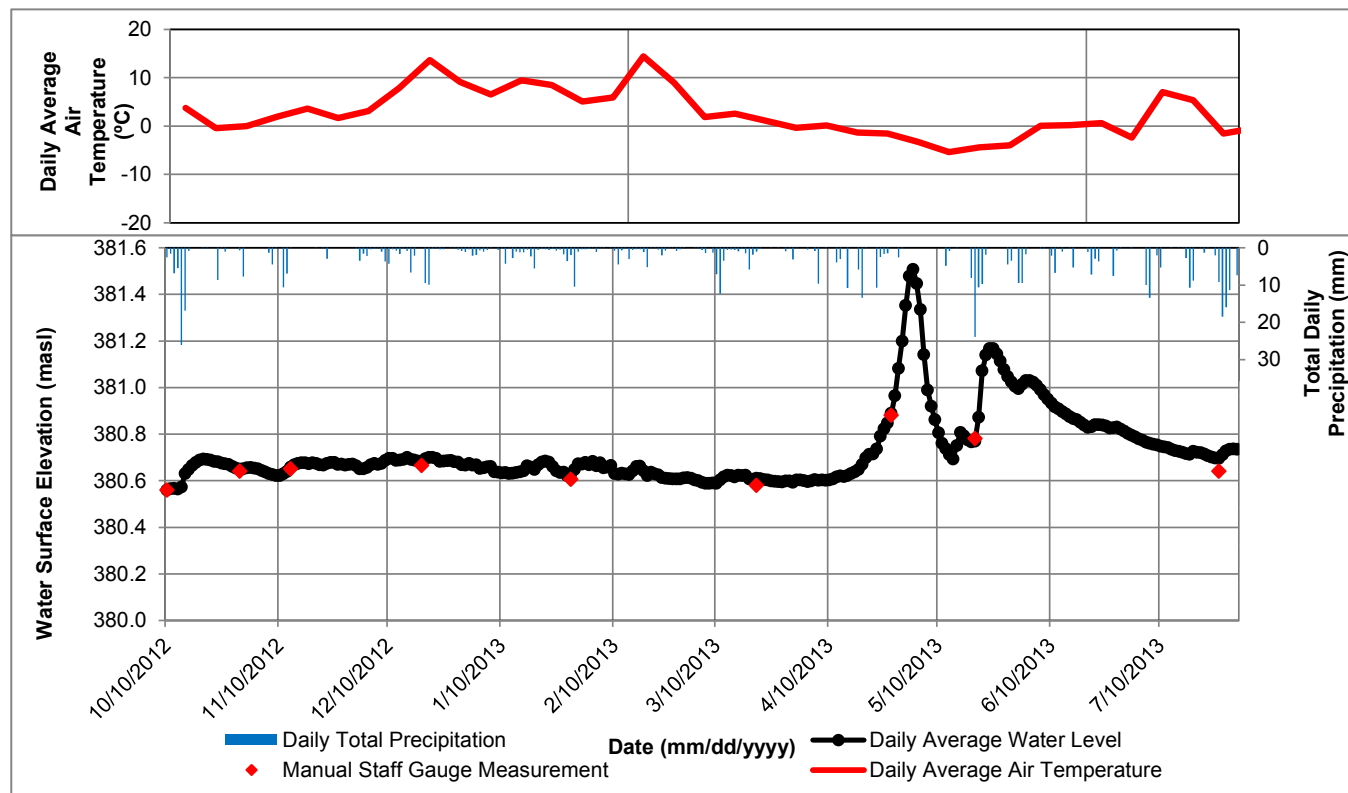
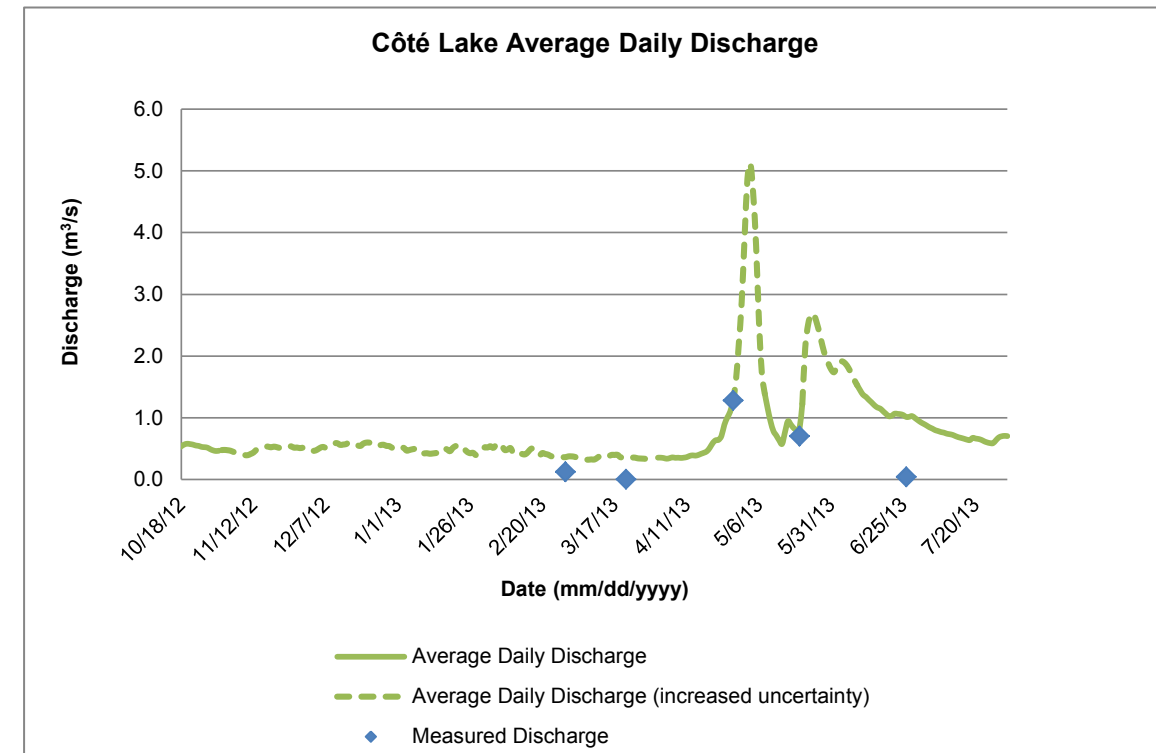

Date	Discharge (m ³ /s)	Water Surface Elevation (masl)
10-Oct-12	n/a*	380.56
30-Oct-12	n/a*	380.64
13-Nov-12	n/a*	380.65
19-Dec-12	n/a*	380.67
29-Jan-13	n/a*	380.61
28-Feb-13	0.12	n/a*
21-Mar-13	n/a*	380.58
27-Apr-13	1.28	380.88
20-May-13	0.70	380.78
26-Jun-13	0.04	380.64

*no measurement taken

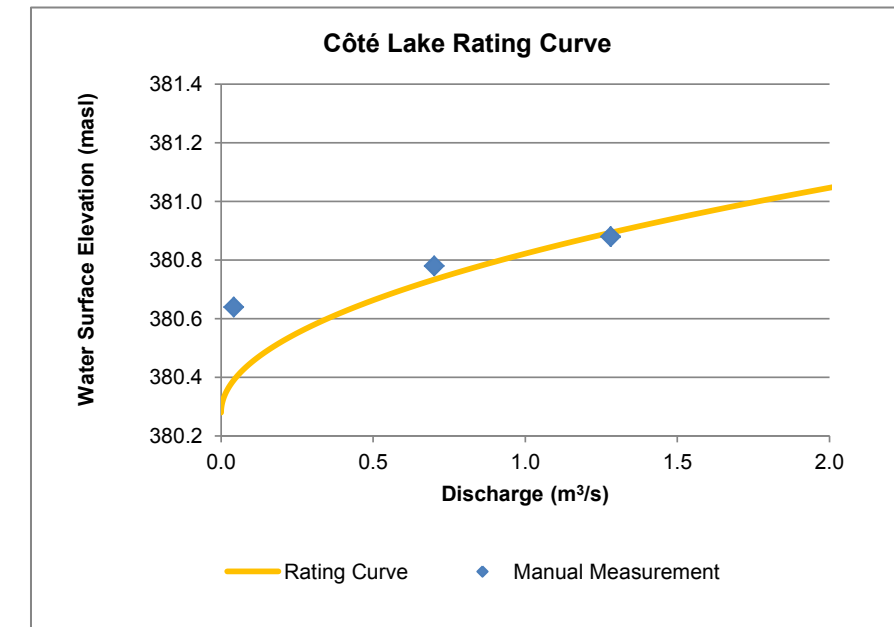

Watercourse Name:	Cote Lake	Station Description	Monitoring location CL is located at a gravel road crossing of the Mollie River at the outflow of Côté Lake. This reach of the river conveys flows from Côté Lake to the upper basin of Three Ducks Lake. Three CSP culverts of 2.0 m diameters provide flow conveyance across the road. These culverts were installed September 2012. The area surrounding the station is heavily forested. The creek bed is characterised by mud and sediment with dense wetland vegetation adjacent to the channel.
UTM Coordinates:	430163.58 E, 5267486.38 N		
Staff Gauge Elevation:	381.28 masl (top of gauge)		



Equipment Installed

The staff gauge and logger are affixed to the inlet of the culvert closest to the right bank. The level logger was installed on October 10, 2012.

Côté Lake (CL) Flow Monitoring Station

PROJECT: 13-1192-0021(1000/1020) DATE: Nov-13

IAMGOLD Côté Gold

SHEET 6



Upstream



Downstream

note: flow becomes increasingly channelised downstream of photo extent

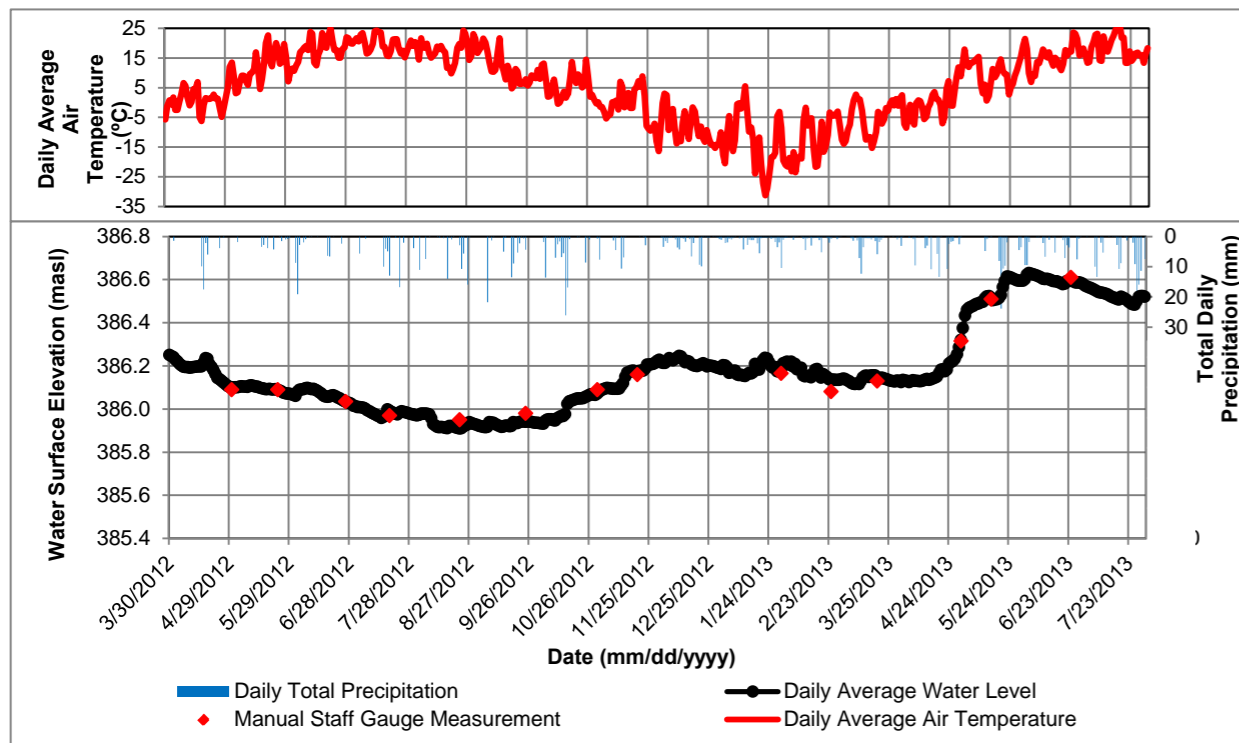
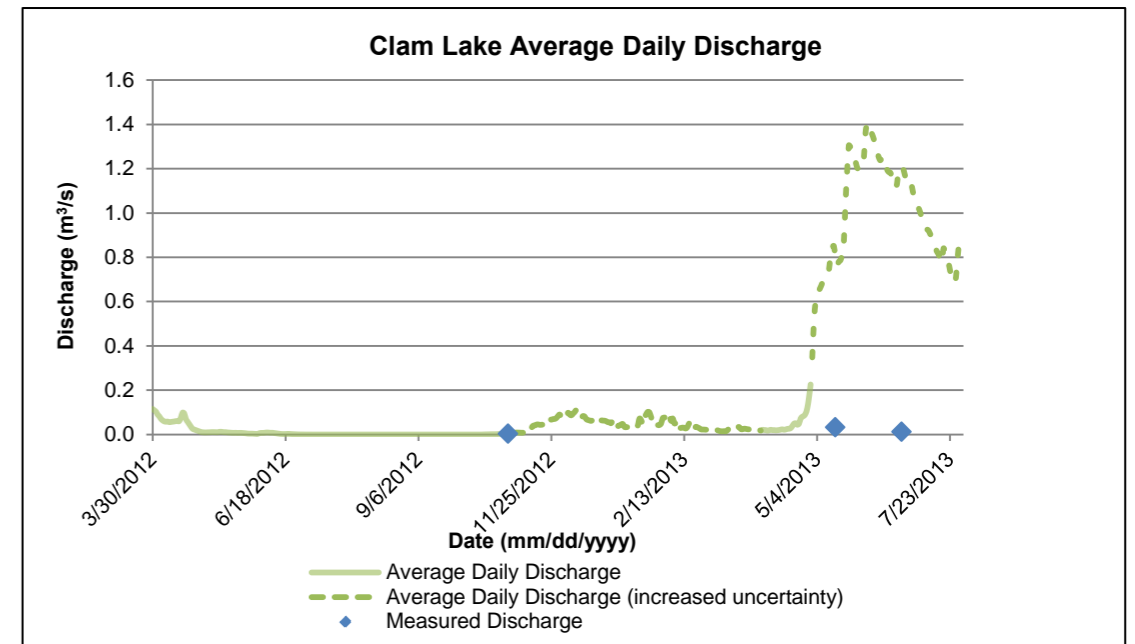

Date	Discharge (m ³ /s)	Water Surface Elevation (masl)	Comments
27-Mar-12	0.15	386.28	
30-Apr-12	n/a*	386.09	Beaver activity
23-May-12	n/a*	386.09	Beaver activity
26-Jun-12	n/a*	386.04	
18-Jul-12	n/a*	385.97	
22-Aug-12	n/a*	385.95	
24-Sep-12	n/a*	385.98	Beaver activity
30-Oct-12	0.003	386.09	Beaver activity
19-Nov-12	n/a*	386.17	Beaver activity
30-Jan-13	n/a*	386.165	
24-Feb-13	n/a*	386.08	
19-Mar-12	n/a*	386.13	
29-Apr-13	n/a*	386.32	
15-May-13	0.03	386.51	
24-Jun-13	0.01	386.61	

*no measurement taken

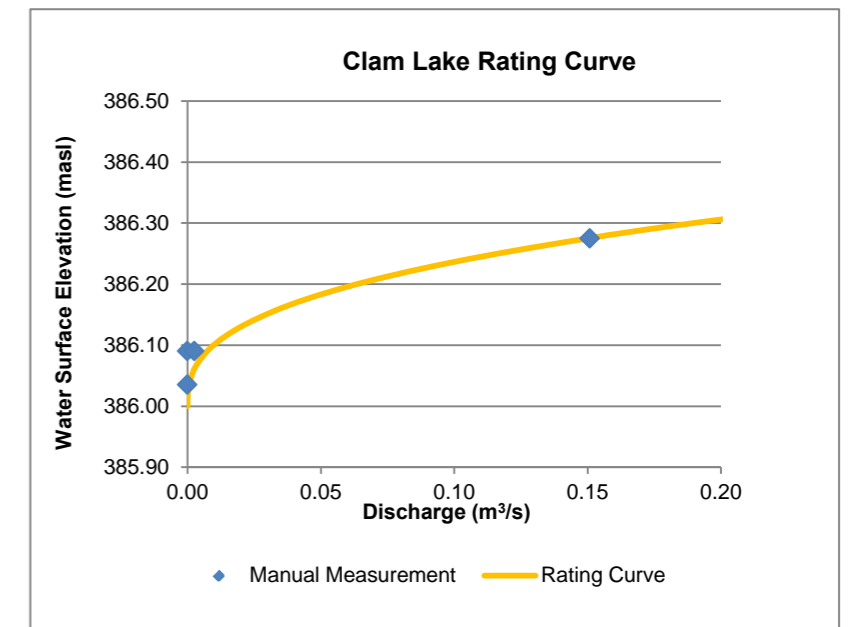

Watercourse Name:	Clam Lake	Station Description	CM is located at a gravel road crossing of Clam Lake. Two CSP culverts 1.5 m diameter provide flow conveyance across the road. The culverts are in poor condition and are significantly obstructed by beaver debris. The area surrounding the station is heavily forested. The lakebed is characterised by mud and sediment with some grasses along the shoreline.
UTM Coordinates:	428623.51 E, 5267120.59 N		
Staff Gauge Elevation:	386.77 masl (top of gauge)		
		Equipment Installed	The staff gauge and logger are located upstream of the crossing, near the inlet of the culvert closest to the right bank. The level logger was installed in March 2012. The flow measurement was taken at the culvert crossing or in the channel downstream of the crossing.
PROJECT:	13-1192-0021(1000/1020)	DATE:	Nov-13
		Clam Lake (CM) Flow Monitoring Station	
		IAMGOLD Côté Gold	SHEET 7



Upstream



Downstream

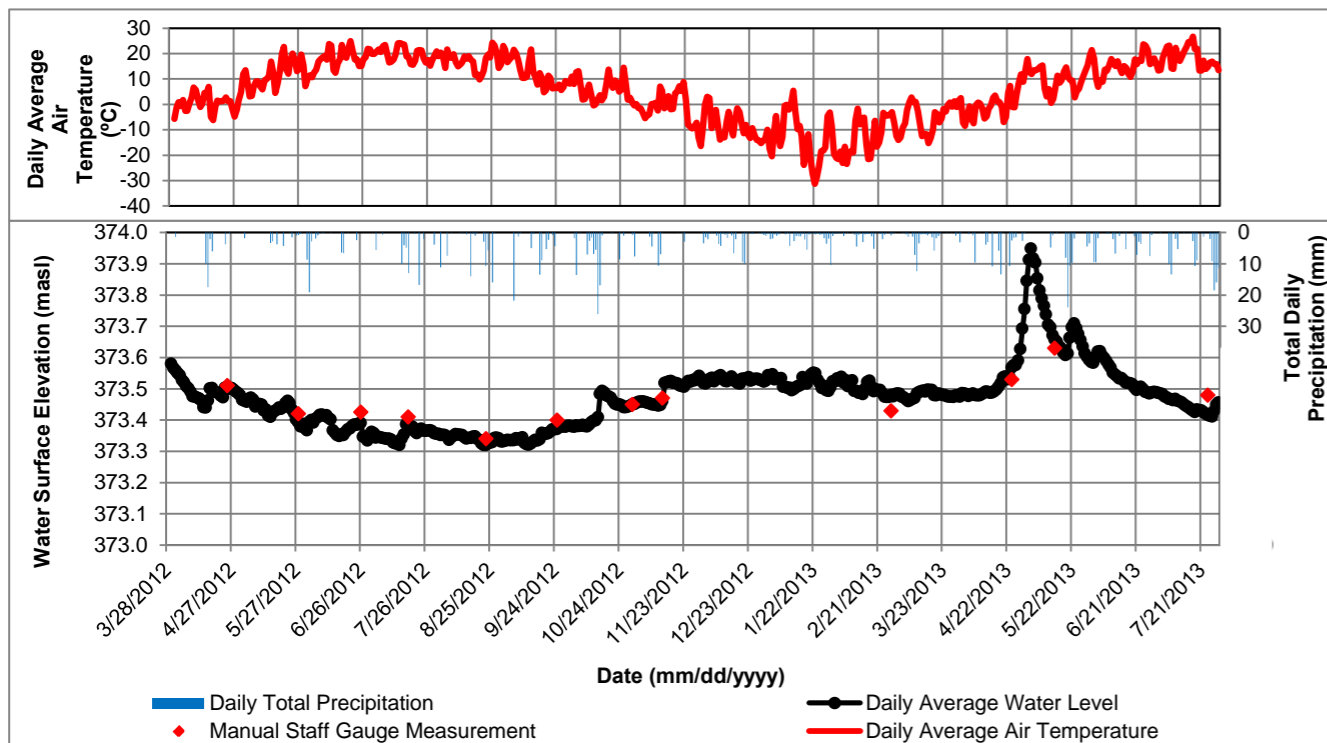
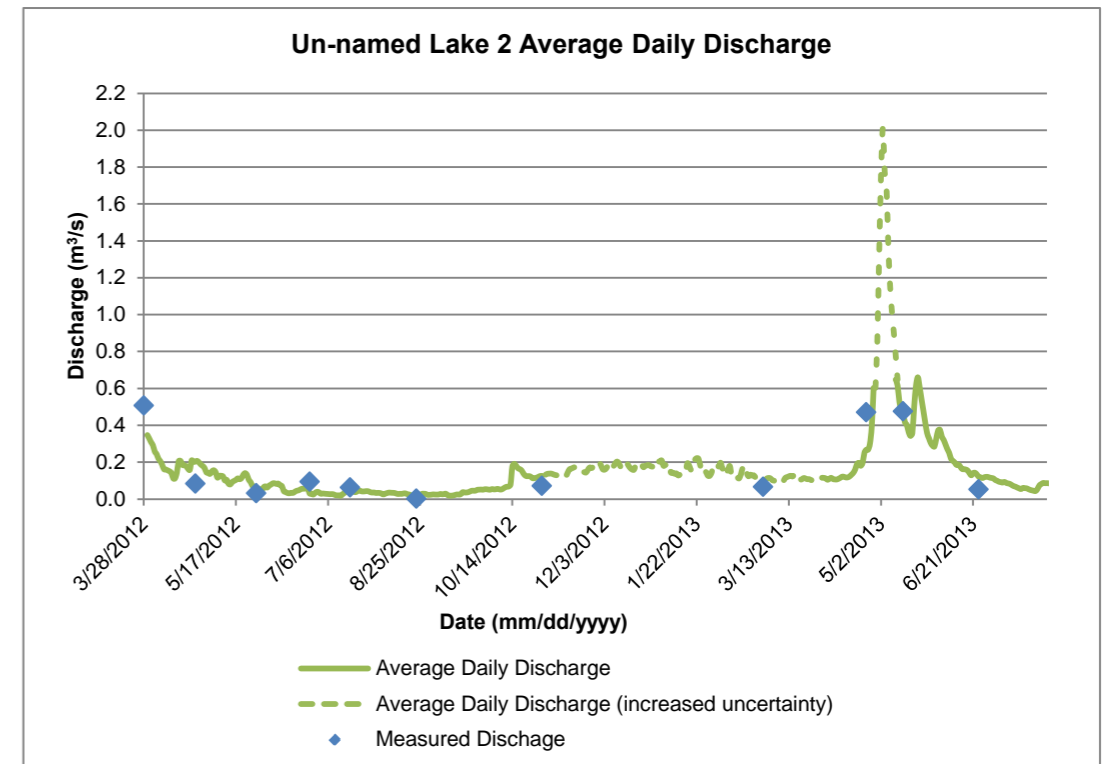

Date	Discharge (m³/s)	Water Surface Elevation (masl)
28-Mar-12	0.51	373.67
25-Apr-12	0.08	373.51
28-May-12	0.03	373.42
26-Jun-12	0.09	373.43
18-Jul-12	0.06	373.41
23-Aug-12	0.00	373.34
25-Sep-12	n/a*	373.4
30-Oct-12	0.07	373.45
13-Nov-12	n/a*	373.47
27-Feb-13	0.07	373.43
24-Apr-13	0.47	373.53
14-May-13	0.48	373.63
24-Jun-13	0.05	373.48

*no measurement taken

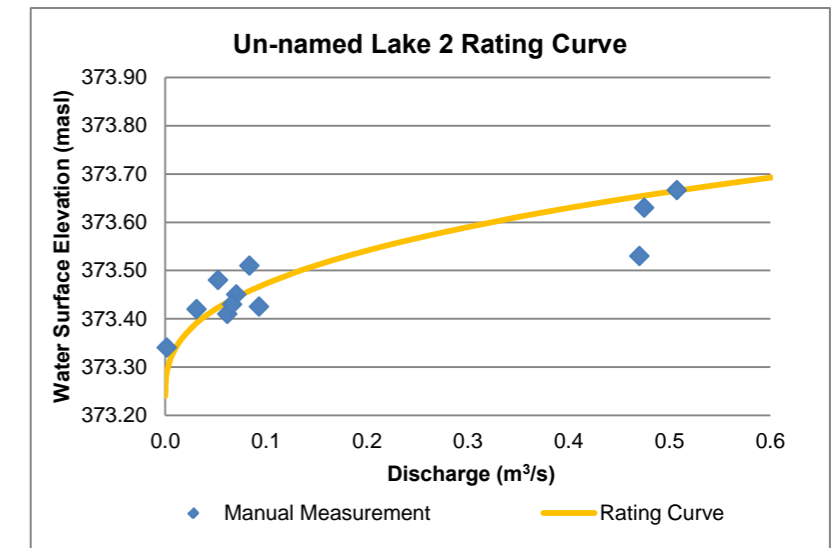

Watercourse Name:	Un-named Lake 2	Station Description	Station L-2 is located at a gravel road crossing of a tributary to Bagsverd Creek upstream of the BL-b watershed. Two CSP culverts with approximate diameters of 1.2 m provide flow conveyance across this road. The area surrounding the location is heavily forested. There is a wetland area located approximately 50 m upstream of the location. The channel is lined with fine to course cobbles with dense wetland grasses adjacent to the main channel.
UTM Coordinates:	428296.72 E, 5273455.66 N		
Staff Gauge Elevation:	374.17 masl (top of gauge)		
		Equipment Installed	The staff gauge and logger are located approximately 15 m upstream of the crossing. There is a rock shelf between the culverts and the staff gauge that controls water levels. The level logger was installed in March 2012. Flow measurements taken at the culvert outlets.
PROJECT:	13-1192-0021(1000/1020)	DATE:	Nov-13

Un-named Lake 2 (L-2) Flow Monitoring Station

IAMGOLD Côte Gold

SHEET 8



Upstream



Downstream

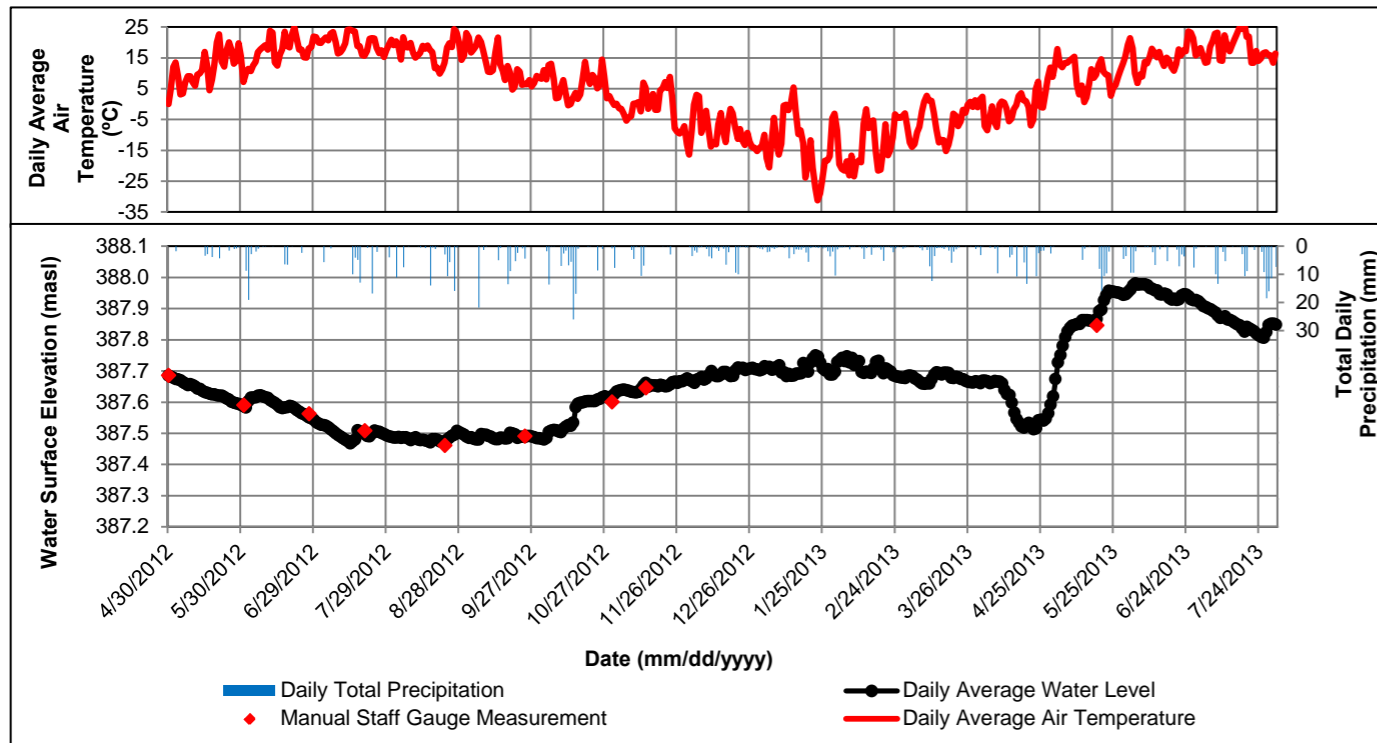

Date	Discharge (m ³ /s)	Water Surface Elevation (masl)	Comments
30-Apr-12	0.0037	387.69	
31-May-12	0.0002	387.59	
27-Jun-12	n/a*	387.56	very low flow
20-Jul-12	n/a*	387.51	very low flow
22-Aug-12	n/a*	387.46	very low flow
24-Sep-12	n/a*	387.49	Beaver activity
30-Oct-12	0.0024	387.60	
13-Nov-12	n/a*	387.65	
18-May-13	0.0010	387.85	Beaver activity
26-Jun-13	0.0542	n/a*	

*no measurement taken

note: rating curve influenced by beaver activity and intermittent flow; curve remains under development with ongoing monitoring program

Watercourse Name:	Little Clam Lake	Station Description	Monitoring location LCM is located at the outlet of Little Clam Lake and discharges to a watercourse contributing to Bagsverd Lake. The area surrounding the location is heavily forested. The wetland bed consists of mud and sediment in the vicinity of LCM. The wetland is characterized by shallow open water with bedrock observed along the banks. A beaver dam approximately 20 cm in height controls water levels and discharge at the outlet. Seepage through the beaver dam was observed on multiple occasions. This seepage flows in a diffuse pattern through long grass and into the forest.
UTM Coordinates:	428483.826 E, 5267779.043 N		
Staff Gauge Elevation:	387.58 masl (top of gauge)		
		Equipment Installed	The staff and level logger are located upstream of the beaver dam. The logger was installed on April 30, 2012. Three of manual flow measurements from June through August resulted in un-measurable flow velocities. Due to flow measurements not capturing seepage from the entire length of the dam, the low-flow measurement location was moved downstream in late October 2012. The low-flow measurement location is approximately 240 m north of the level logger where the watercourse crosses an access trail.
PROJECT:	13-1192-0021(1000/1020)	DATE:	Nov-13

Little Clam Lake (LCM) Flow Monitoring Station

IAMGOLD Côté Gold

SHEET 9



Upstream



Downstream

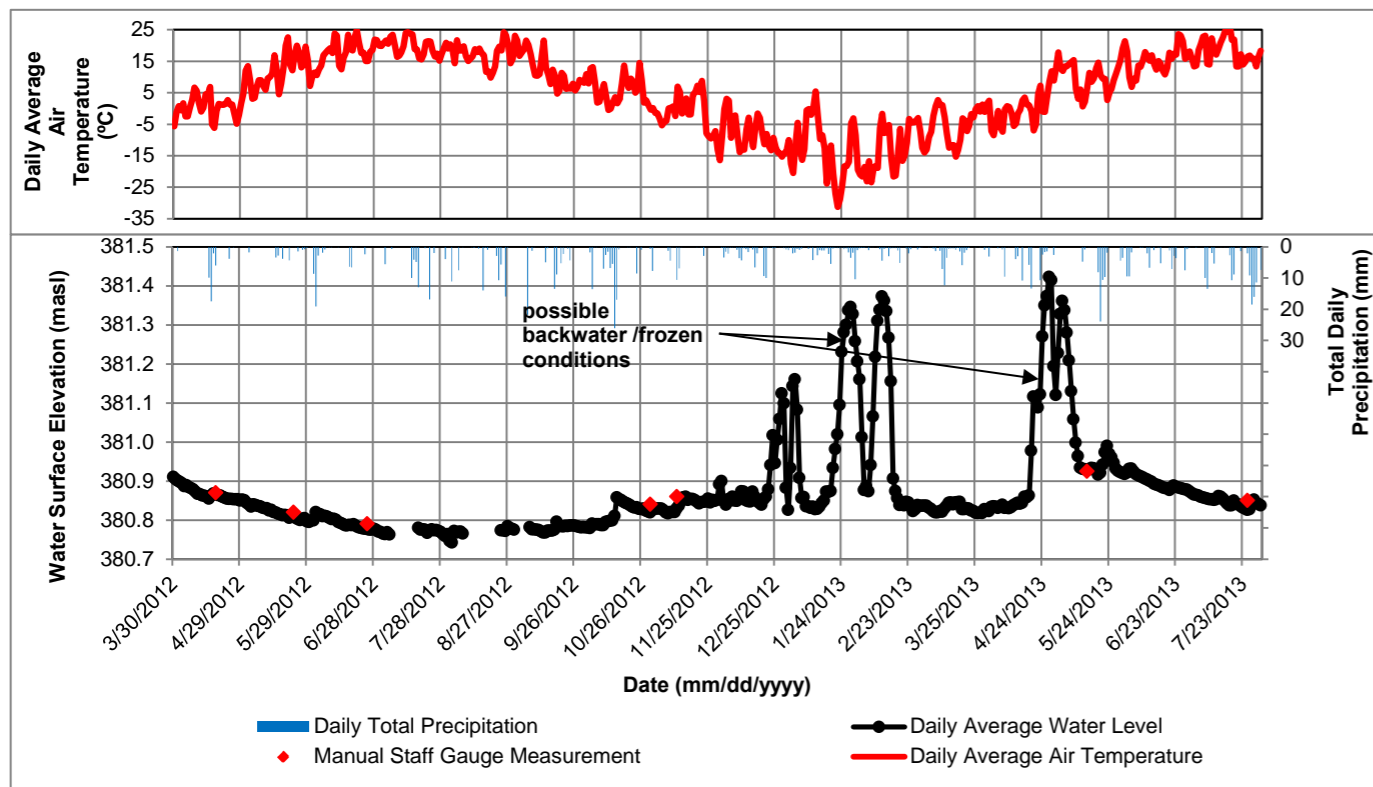

Date	Discharge (m ³ /s)	Water Surface Elevation (masl)	Comments
26-Mar-12	0.06	n/a*	
18-Apr-12	0.02	380.87	Possible back water from Three Duck Lakes
23-May-12	n/a*	380.82	
25-Jul-12	n/a*	380.79	
30-Oct-12	0.15	380.84	
11-Nov-12	n/a*	380.86	
29-Jan-13	n/a*	n/a*	Frozen, water backed up
29-Apr-13	n/a*	n/a*	Frozen, ice in culvert
14-May-13	0.07	380.93	
25-Jun-13	0.09	380.85	

*no measurement taken

note: insufficient data for rating curve development; curve remains under development with ongoing monitoring program

Watercourse Name:	Mill Pond	Station Description	Monitoring location MP is located at a gravel road crossing of a watercourse conveying flows from the Mill Pond to the upper basin of Three Ducks Lake. A CSP culvert of 1.2 m diameter provides flow conveyance across the road. This culvert was installed during the summer of 2011. The area surrounding the station is heavily forested. The channel bed is characterised by sediment and grasses as the watercourse meanders through dense bush upstream and downstream of the location.
UTM Coordinates:	431991.80 E, 5267531.02 N		
Staff Gauge Elevation:	381.45 masl (top of gauge)		
		Equipment Installed	The staff gauge and logger are located immediately upstream of the culvert. The level logger was installed on March 30, 2012. Flow measurements were taken at the culvert outlet.
PROJECT:	13-1192-0021(1000/1020)	DATE:	Nov-13
			Mill Pond (MP) Flow Monitoring Station
			IAMGOLD Côté Gold SHEET 10



Upstream



Downstream

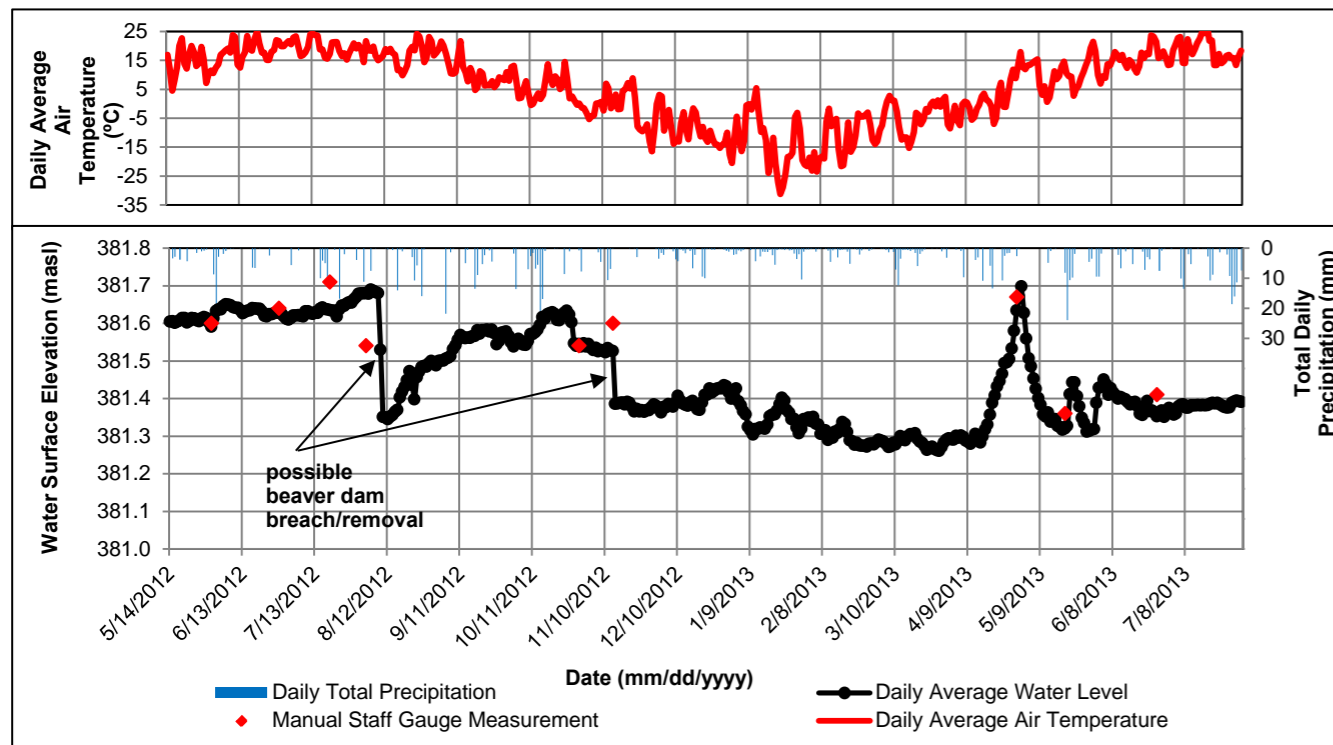

Date	Discharge (m ³ /s)	Water Surface Elevation (masl)	Comments
27-Mar-12	0.213	381.39	
30-Apr-12	0.035	381.63	
31-May-12	0.001	381.60	
28-Jun-12	0.003	381.64	
19-Jul-12	0.016	381.71	
22-Aug-12	n/a*	381.5	Beaver dam was removed
25-Sep-12	n/a*	381.59	
30-Oct-12	0.012	381.54	
21-Nov-12	0.022	381.39	
18-Dec-12	n/a*	381.40	Frozen, staff guage reading taken at ice
29-Apr-13	n/a*	381.67	
19-May-13	0.041	381.36	
26-Jun-13	n/a*	381.41	

*no measurement taken

note: rating curve influenced by beaver activity and intermittent flow; curve remains under development with ongoing monitoring program

Watercourse Name:	West Beaver Pond	Station Description	Monitoring location P-6 is located at the outlet of a wetland contributing to Bagsverd Lake. The area surrounding the station is heavily forested. The upstream wetland is characterized by shallow open water with wetland grasses adjacent to the forested upland areas. A beaver dam at the outlet of the wetland influences discharge rates and water levels. Along with flow over the crest of the dam, seepage through the structure has been observed. On October 12, 2012 a survey found the head difference from the wetland to the watercourse below the beaver dam to be approximately 0.8 m.
UTM Coordinates:	427782.69 E, 5268055.87 N		
Staff Guage Elevation:	381.80 masl (top of staff gauge)		
		Equipment Installed	The staff gauge and logger are located approximately 10 m upstream of the beaver dam. The level logger was installed in May 2012. Flow measurements were taken downstream of the beaver dam.
PROJECT:	13-1192-0021(1000/1020)	DATE:	Nov-13
			West Beaver Pond (P-6) Flow Monitoring Station
			IAMGOLD Côté Gold SHEET 11



Upstream



Downstream

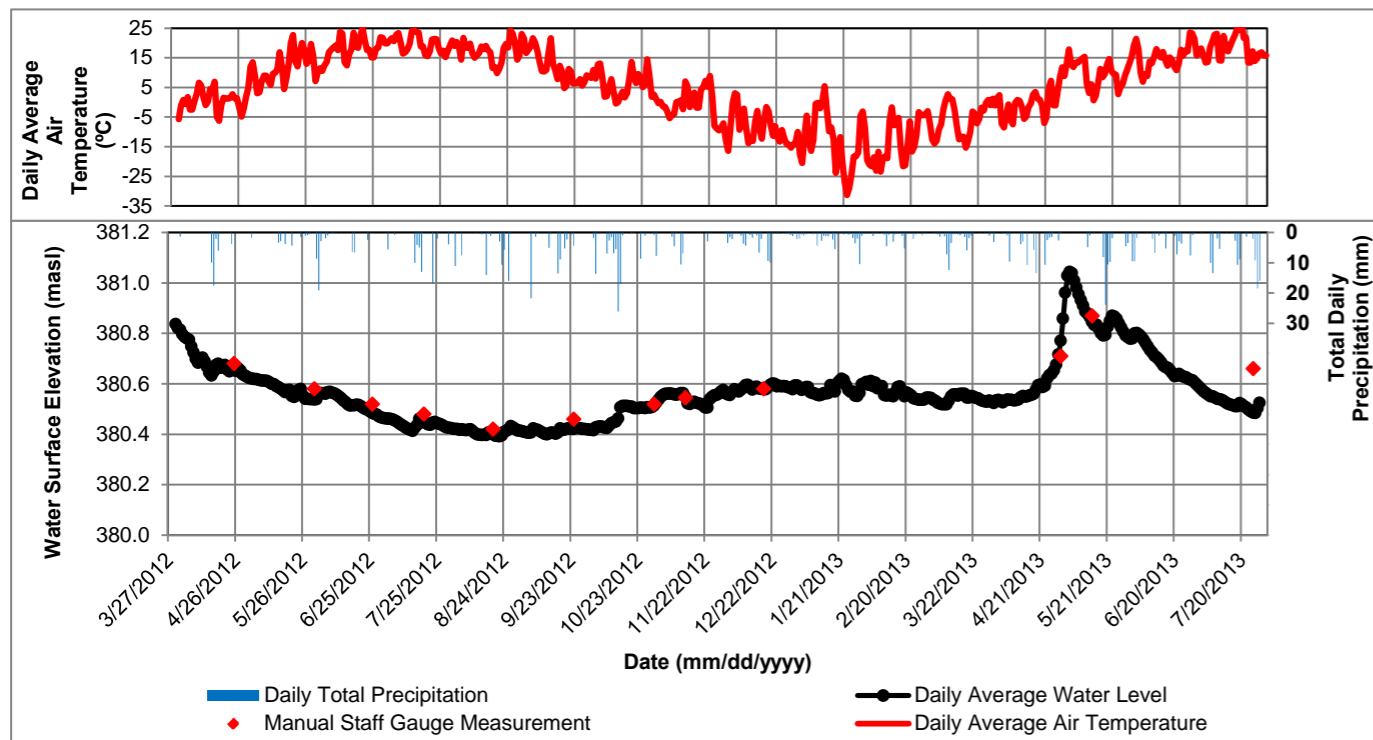
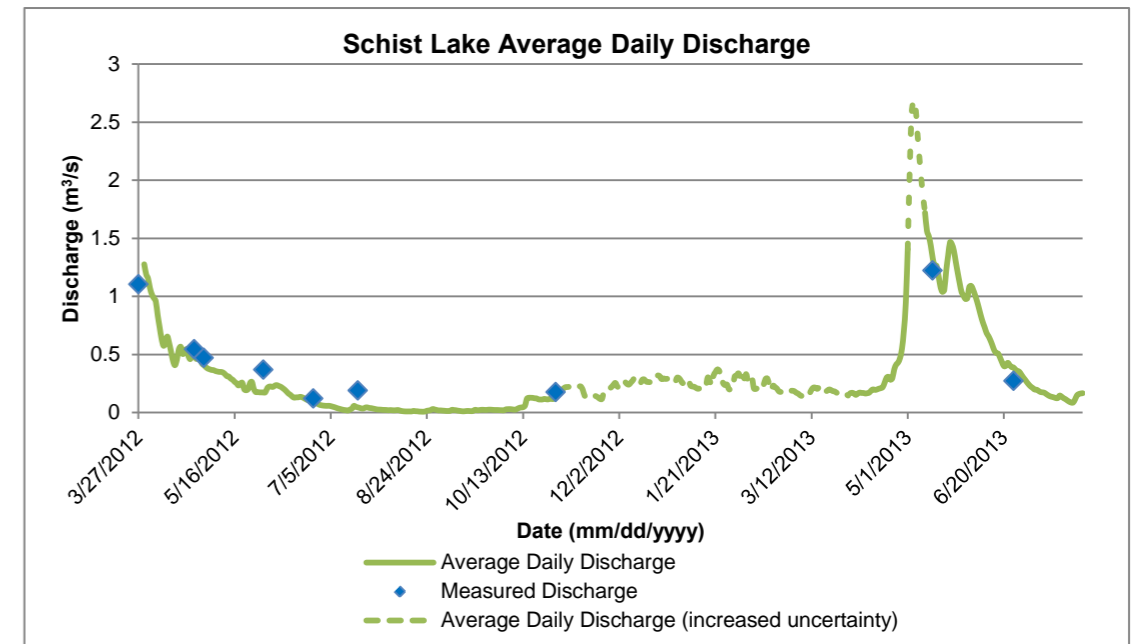

Date	Discharge (m ³ /s)	Water Surface Elevation (masl)
27-Mar-12	1.11	380.81
25-Apr-12	0.55	380.68
31-May-12	0.37	380.58
26-Jun-12	0.12	380.52
19-Jul-12	0.19	380.48
19-Aug-12	n/a*	380.42
24-Sep-12	n/a*	380.46
30-Oct-12	0.18	380.52
21-Nov-12	n/a*	380.57
18-Dec-12	n/a*	380.58
27-Feb-12	0.26	n/a*
19-Mar-12	0.31	n/a*
30-Apr-12	0.47	380.71
14-May-13	1.22	380.87
25-Jun-13	0.27	380.66

*no measurement taken

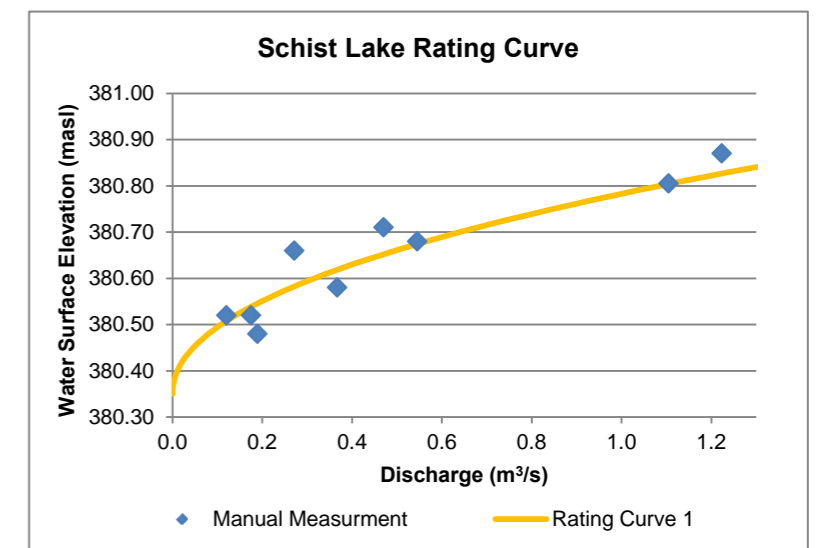

Watercourse Name:	Schist Lake	Station Description	Monitoring location SL is located at bridge spanning the connecting waterway between Schist Lake (upstream) and Bagsverd Lake (downstream). The area surrounding the station is heavily forested. The creek bed is characterised by a cobble channel and bedrock banks.
UTM Coordinates:	428496.46 E, 5269771.17 N		
Staff Gauge Elevation:	381.32 masl		
		Equipment Installed	The staff gauge and logger are located near the right channel bank approximately 25 m upstream of the crossing. The level logger was installed in March 2012. Flow measurements were taken approximately 10 m downstream of the bridge (see downstream photo).
PROJECT:	13-1192-0021(1000/1020)	DATE:	Nov-13

Schist Lake (SL) Flow Monitoring Station

IAMGOLD Côté Gold

SHEET 12



Upstream



Downstream

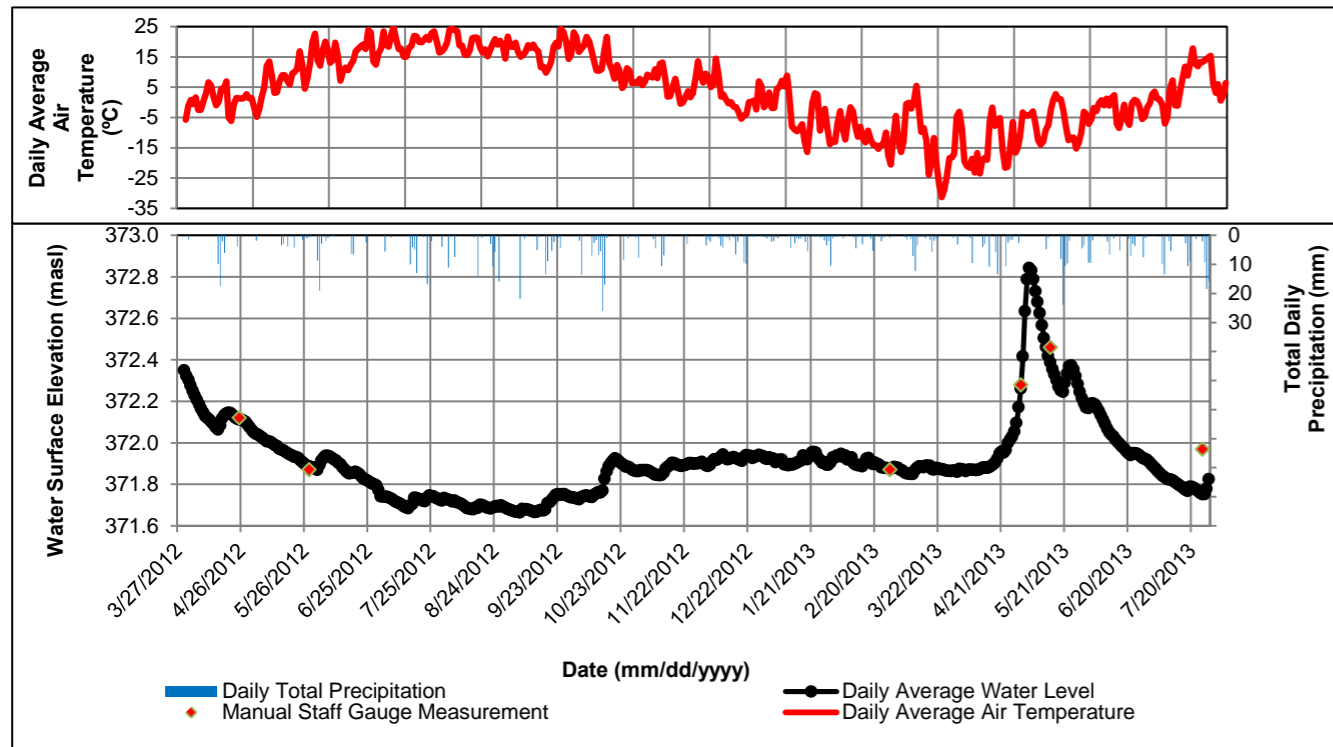
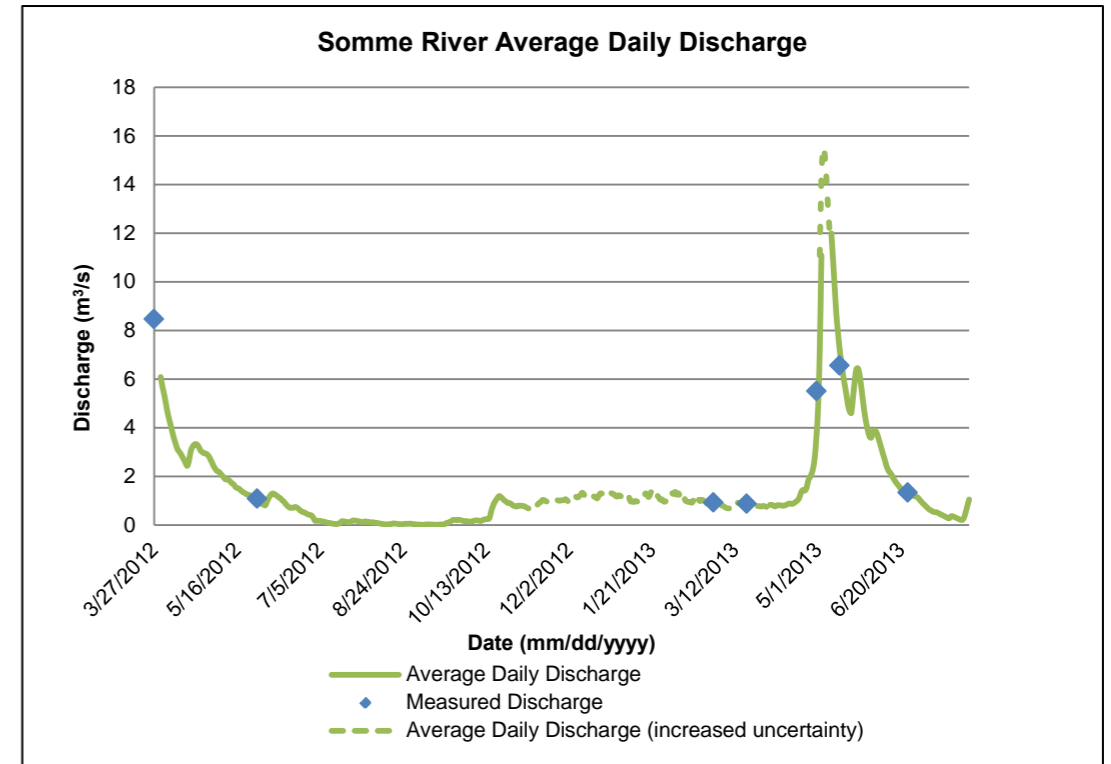

Date	Discharge (m³/s)	Water Surface Elevation (masl)
27-Mar-12	8.46	372.48
25-Apr-12	n/a*	372.12
28-May-12	1.08	371.88
13-Nov-12	n/a*	371.88
18-Dec-12	n/a*	371.9
27-Feb-13	0.92	371.87
19-Mar-13	0.87	n/a*
30-Apr-13	5.51	372.28
14-May-13	6.55	372.46
24-Jun-13	1.34	371.97

*no measurement taken

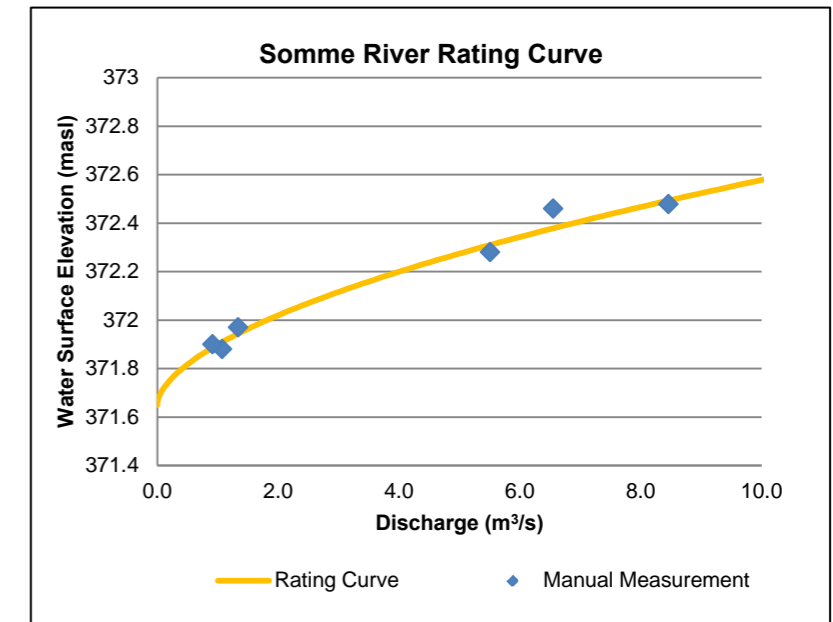

Watercourse Name:	Somme River	Station Description	Monitoring location SR is located at a gravel road crossing of the Somme River. Four Corrugated Steel Pipe (CSP) culverts with approximate diameters of 1.8 m provide flow conveyance across this road. Neville Lake is located downstream of SR while Somme Lake is located upstream. The slope of the channel immediately downstream of the crossing is relatively steep and has little substrate on top of the bedrock and the surrounding area is heavily forested.
UTM Coordinates:	429893.99 E, 5280152.55 N		
Staff Gauge Elevation:	327.87 masl (top of gauge)		
		Equipment Installed	The staff gauge and water level data logger (i.e. logger) are located adjacent to the inlet of the second culvert from the left bank. The logger was installed in March 2012. Flow measurements were taken at the culvert outlets.
PROJECT:	13-1192-0021(1000/1020)	DATE:	Nov-13
			Somme River (SR) Flow Monitoring Station
			IAMGOLD Côté Gold SHEET 13



Upstream



Downstream

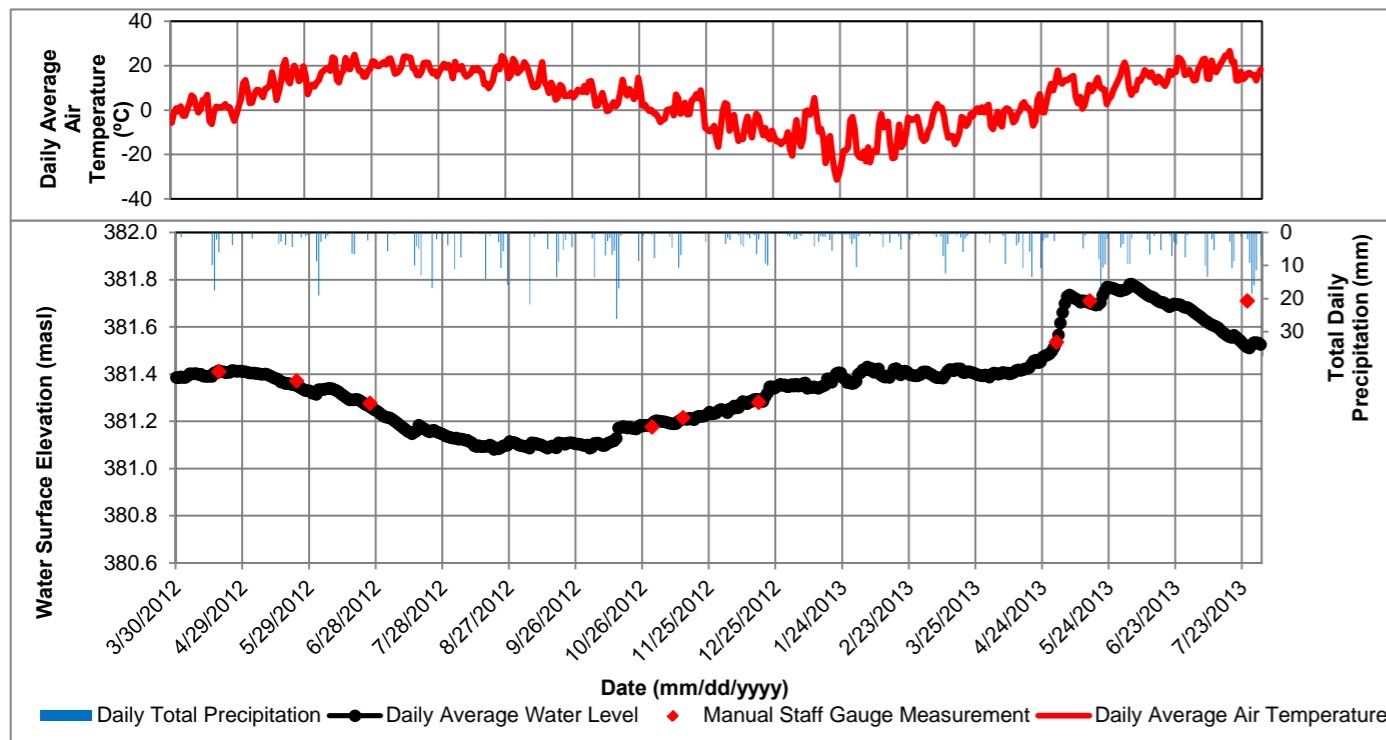

Date	Discharge (m ³ /s)	Water Surface Elevation (masl)
18-Apr-12	n/a*	381.41
23-May-12	n/a*	381.37
25-Jun-12	n/a*	381.28
18-Jul-12	n/a*	381.19
24-Sep-12	n/a*	381.11
30-Oct-12	n/a*	381.18
13-Nov-12	n/a*	381.22
17-Dec-12	n/a*	381.28
30-Apr-13	n/a*	381.54
15-May-13	n/a*	381.71
25-Jul-13	n/a*	381.71

*no measurement taken

note: flow is limited to seepage across roadway, no rating curve developed

Watercourse Name:	Weeduck Lake	Station Description	Monitoring location WD is located at a gravel road crossing where Weeduck Lake flows into Three Duck Lakes (upper basin). A culvert of 1.8 m diameter would provide flow conveyance across the roadway., however the submerged culvert is in poor condition and is nearly completely obstructed by beaver debris. As such discharge is primarily seepage through the obstructed culvert and possibly through the roadbed. The area surrounding the station is heavily forested. In the area around the crossing the lake bed consists primarily of mud and accumulated sediment.	
UTM Coordinates:	431441.53 E, 5268135.47 N			
Staff Gauge Elevation:	381.90 masl (top of gauge)			
		Equipment Installed	The staff gauge and logger are located in Weeduck Lake approximately 5 m from the crossing. The level logger was installed on March 30, 2012. Flow measurements were not conducted in at this location due to the submergence/blockage of the culvert.	
PROJECT:	13-1192-0021(1000/1020)	DATE:	Nov-13	Weeduck Lake (WD) Flow Monitoring Station
				IAMGOLD Côté Gold
				SHEET 14



APPENDIX B

Hydrological Monitoring Location Surveys



PLAN SHOWING

DETAIL AT SITE BL-a

11 OCTOBER 2012

SCALE 1 : 500

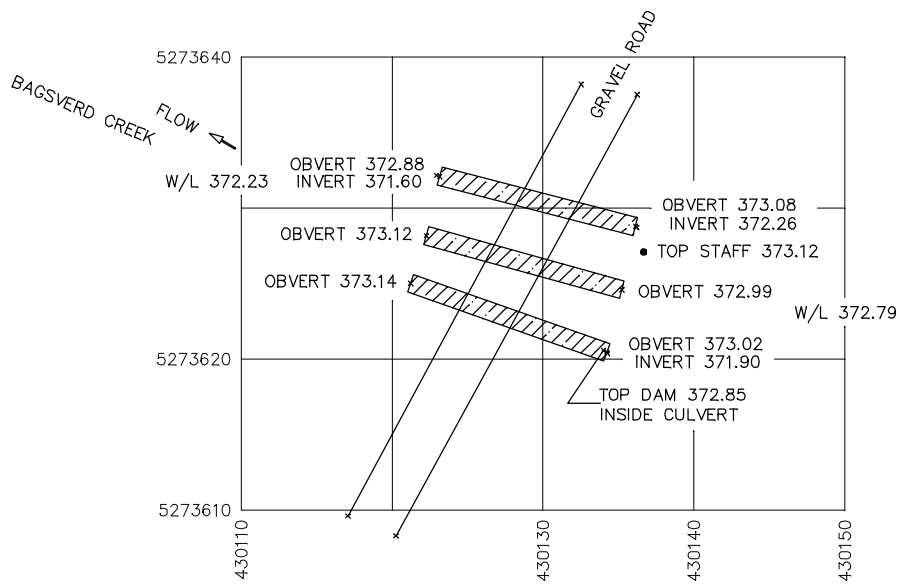

STAFF BL-a
430,136.68
5,273,627.10
373.12

3 CULVERT 1.22 dia. POOR CONDITION



L. LABELLE SURVEYS

TIMMINS, ONTARIO
Phone/Fax (705) 268-8271

PLAN SHOWING
 DETAIL AT SITE BL-b
 11 OCTOBER 2012
 SCALE 1 : 500

STAFF BL-b
 430,572.74
 5,277,424.26
 370.28

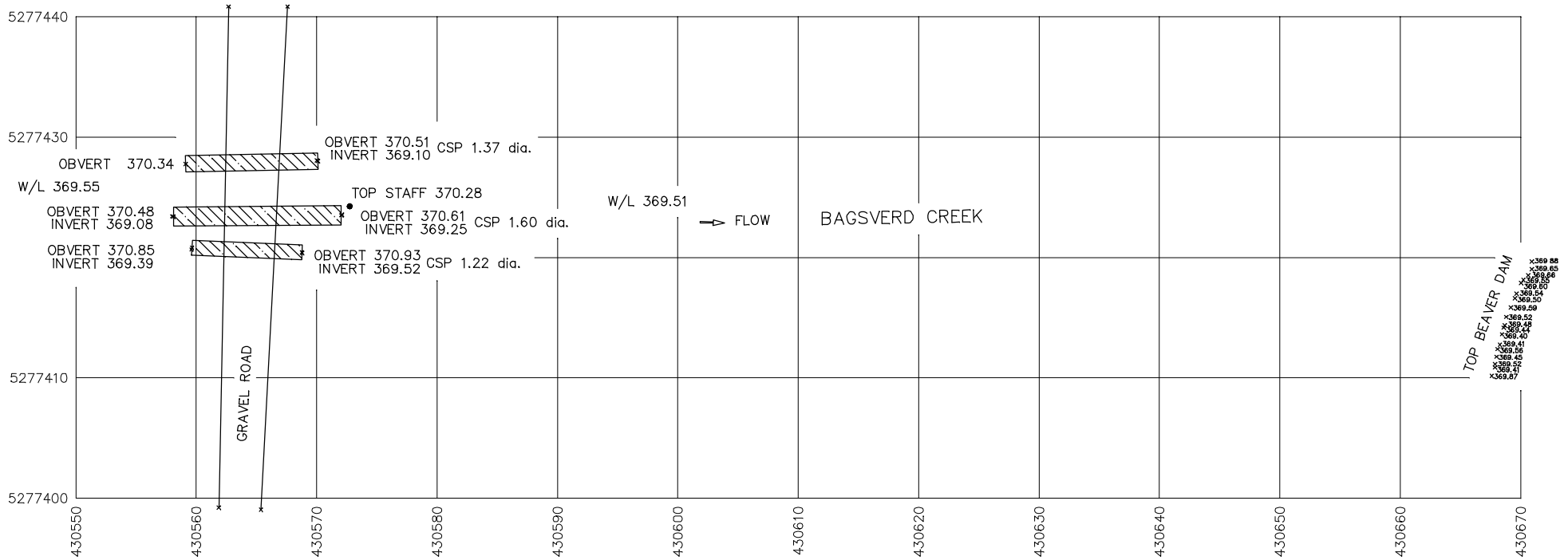

STAFF CHLK-1
 429,883.49
 5,265,373.37
 385.40

PLAN SHOWING
 DETAIL AT SITE CHLK
 9 OCTOBER 2012
 SCALE 1 : 500

TOP STAFF 385.40
 ● w/L 384.65

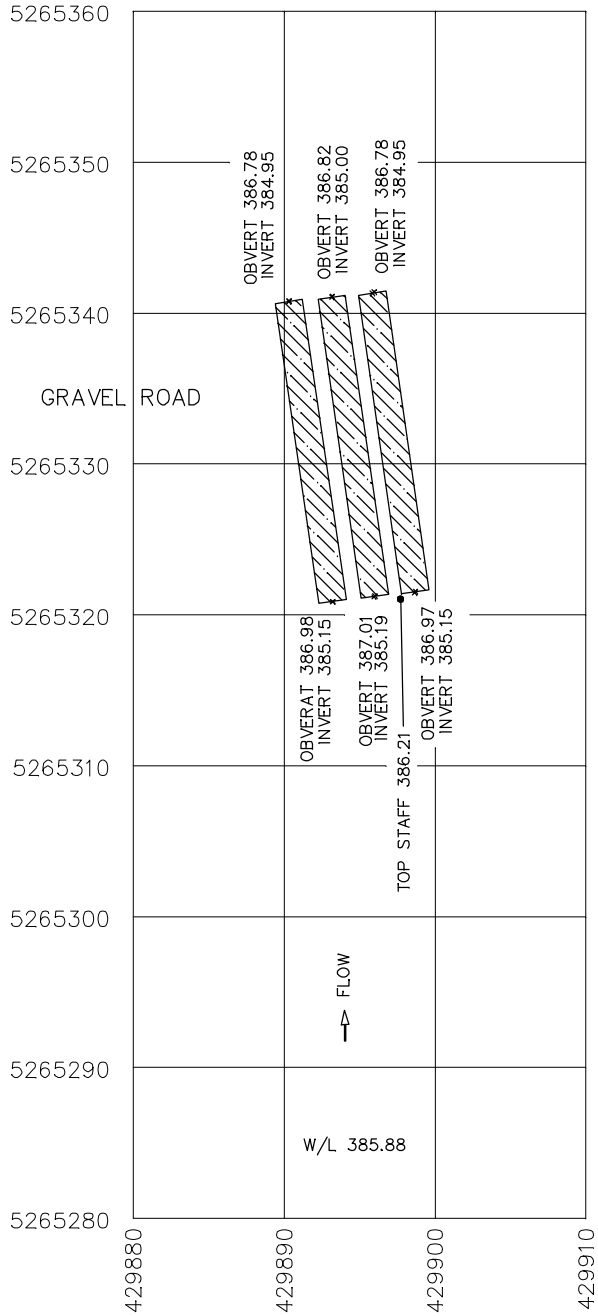

STAFF CHLK-2
 429,897.70
 5,265,321.04
 386.21

3 CULVERTS 1.83 dia.

PLAN SHOWING

DETAIL AT SITE CL

9 OCTOBER 2012

SCALE 1 : 500

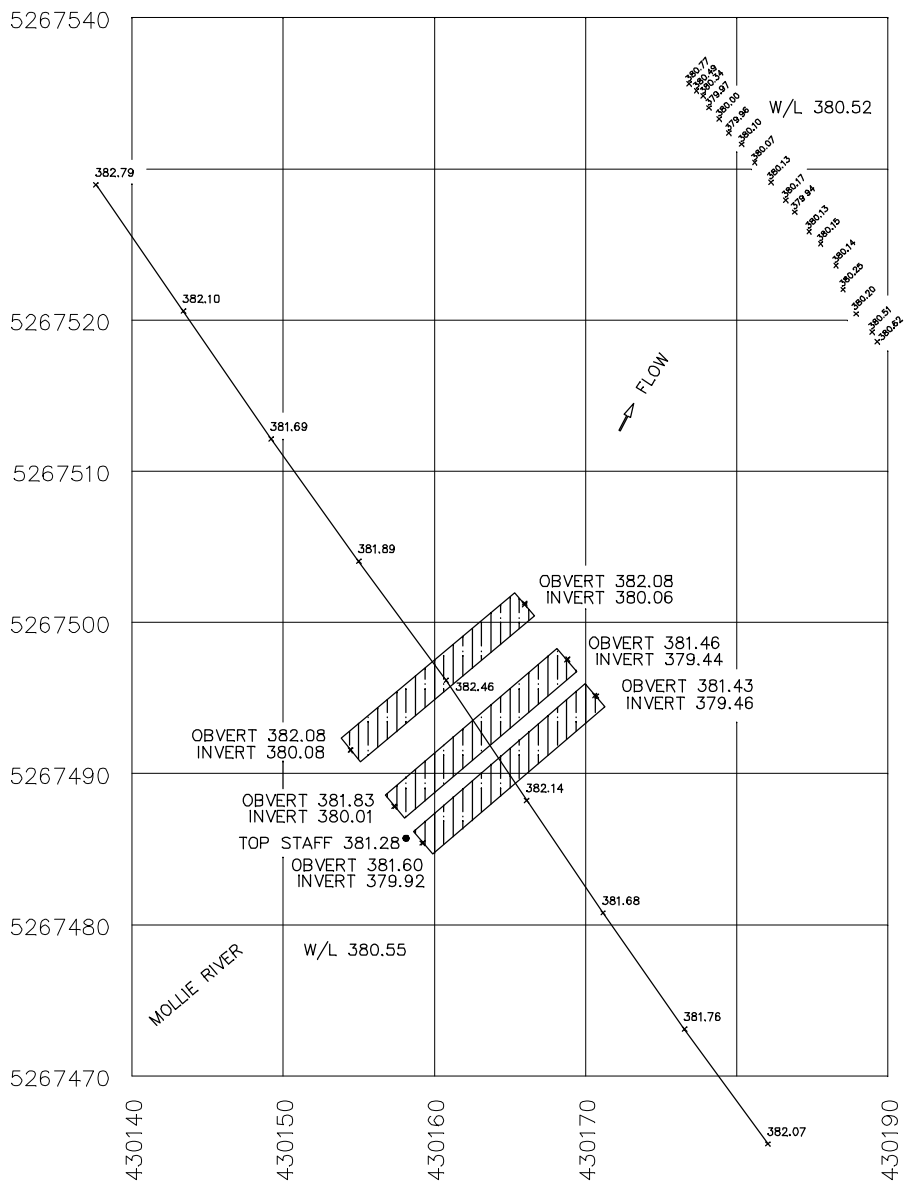

PLAN SHOWING
 DETAIL AT SITE CM
 16 OCTOBER 2012
 SCALE 1 : 500

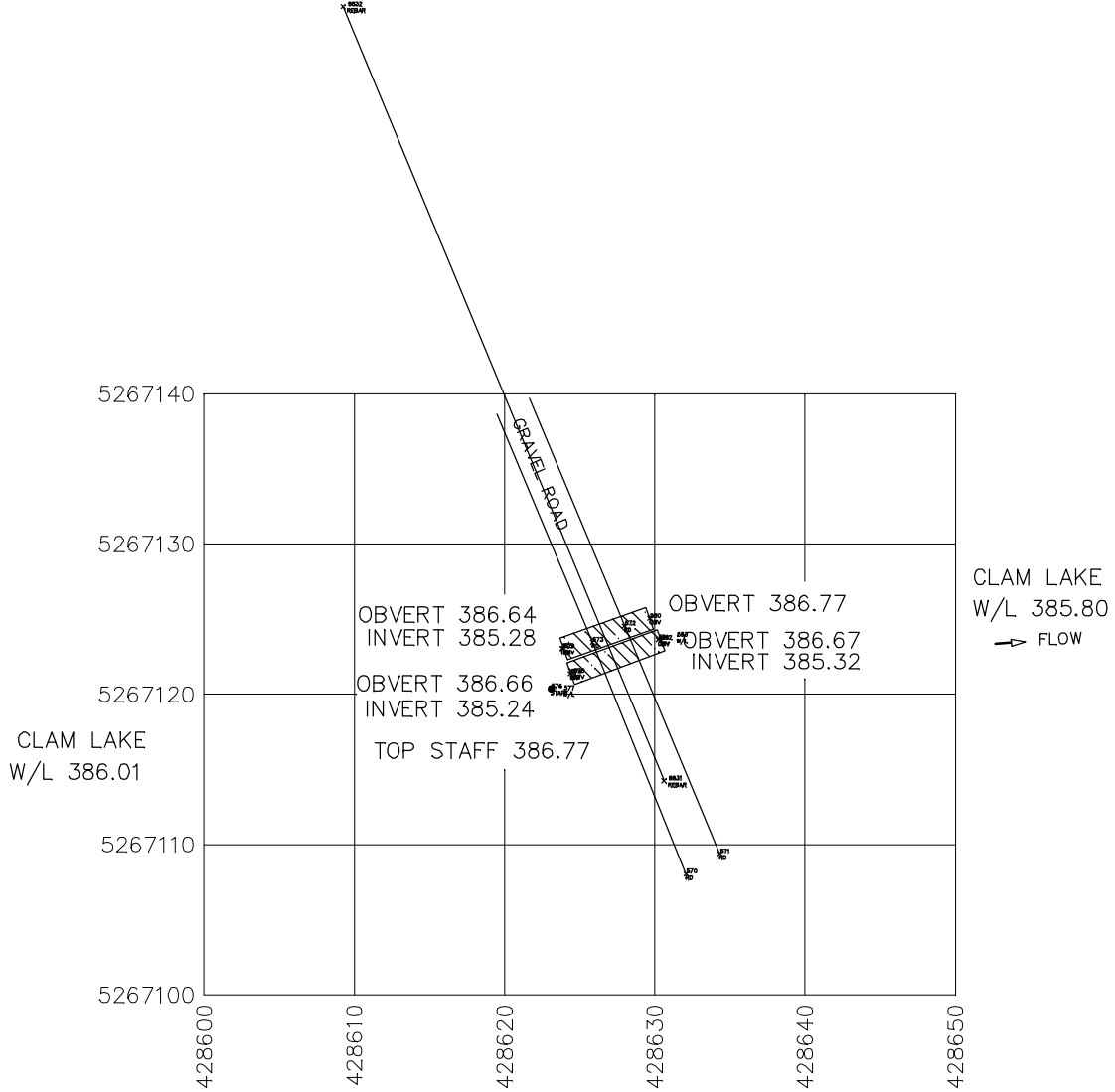

STAFF CM
 428,623.11
 5,267,120.36
 386.77

2 CULVERTS 1.5 dia.



L. LABELLE SURVEYS
 TIMMINS, ONTARIO
 Phone/Fax (705) 268-8271

PLAN SHOWING
 DETAIL AT SITE L2
 11 OCTOBER 2012
 SCALE 1 : 500

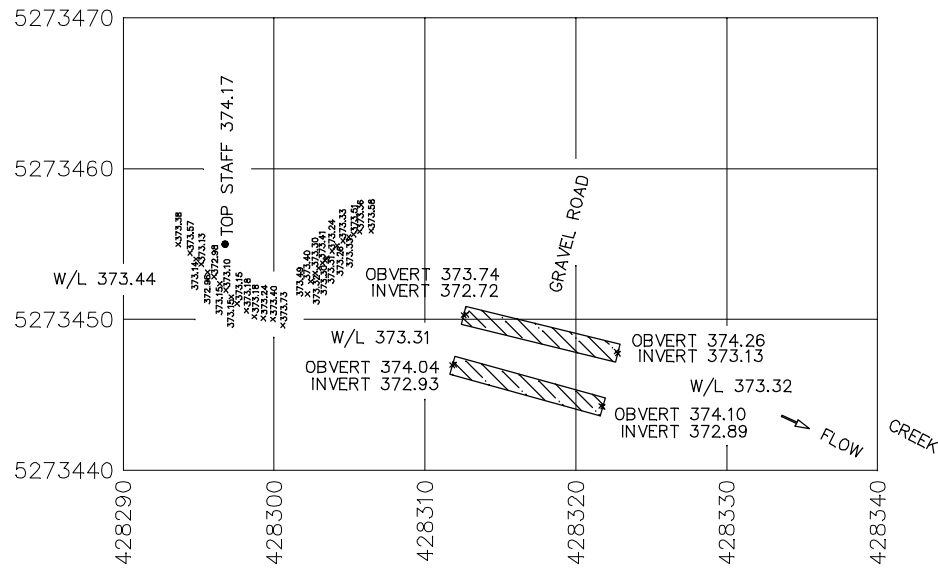

STAFF L2
 428,296.75
 5,273,455.00
 374.17

2 CULVERTS 1.22 dia.



L. LABELLE SURVEYS
 TIMMINS, ONTARIO
 Phone/Fax (705) 268-8271



PLAN SHOWING
DETAIL AT SITE LCM
16 OCTOBER 2012
SCALE 1 : 500

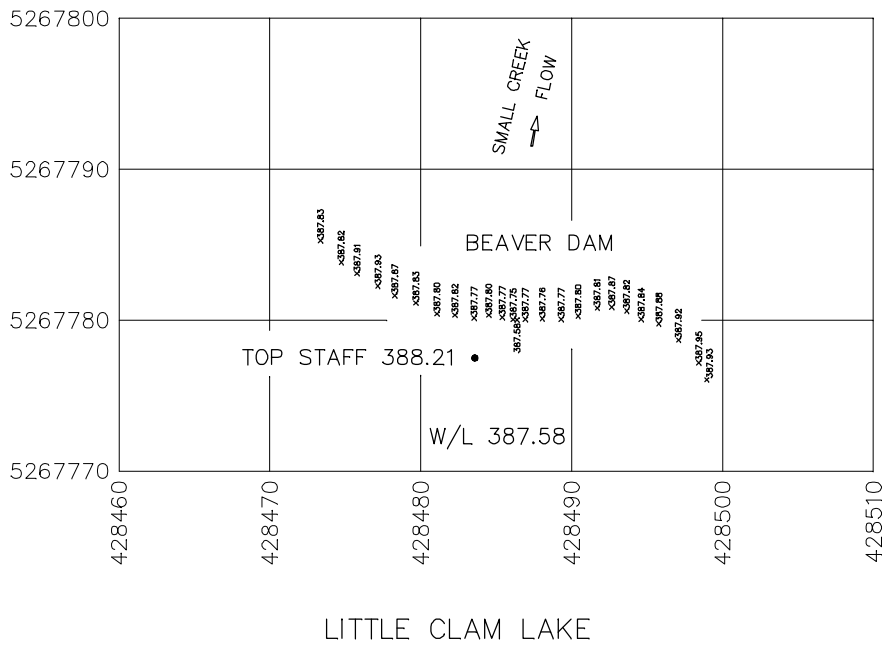

STAFF LCM
428,483.58
5,267,777.49
388.21

NOTE: PROPOSED LOCATION OF FLOW METER
243 METERS NORTH OF STAFF AT:
428,450.30 E
5,268,018.32 N
385.58 ele.



L. LABELLE SURVEYS
TIMMINS, ONTARIO
Phone/Fax (705) 268-8271



PLAN SHOWING
DETAIL AT SITE OUTLET CL
9 OCTOBER 2012
SCALE 1 : 500

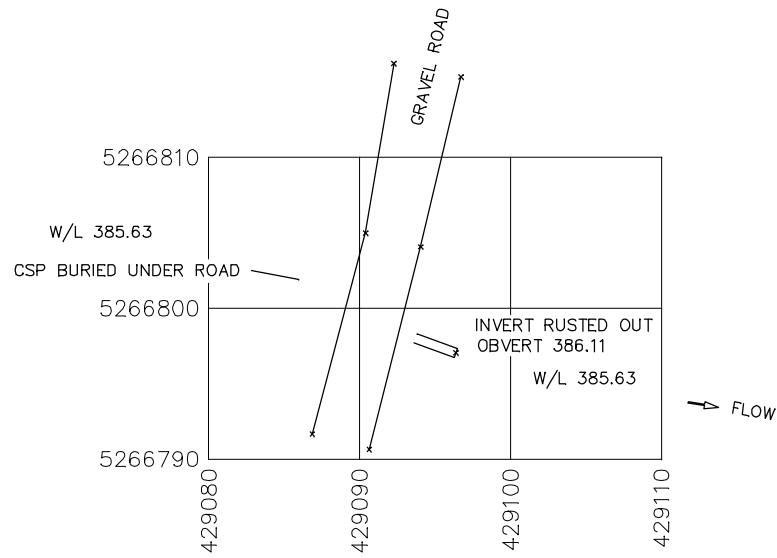

NOTE: W/L AT CLAM CREEK AND
MOLLIE RIVER 380.51
12 OCTOBER 2012

CSP 0.61 dia.



L. LABELLE SURVEYS
TIMMINS, ONTARIO
Phone/Fax (705) 268-8271



PLAN SHOWING
DETAIL AT SITE P-6
12 OCTOBER 2012
SCALE 1 : 500

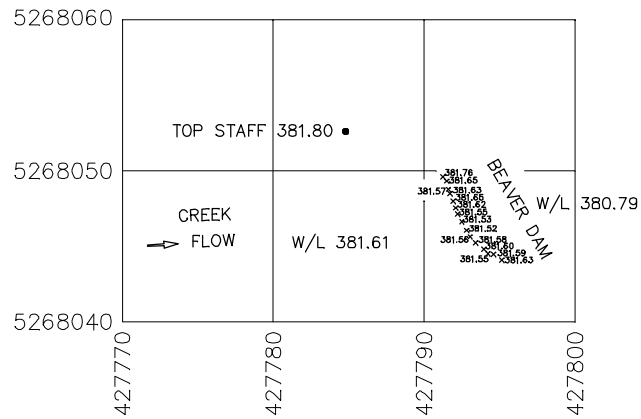

STAFF P-6
427,784.78
5,268,052.61
381.80



L. LABELLE SURVEYS
TIMMINS, ONTARIO
Phone/Fax (705) 268-8271



PLAN SHOWING
DETAIL AT SITE SL
12 OCTOBER 2012
SCALE 1 : 500

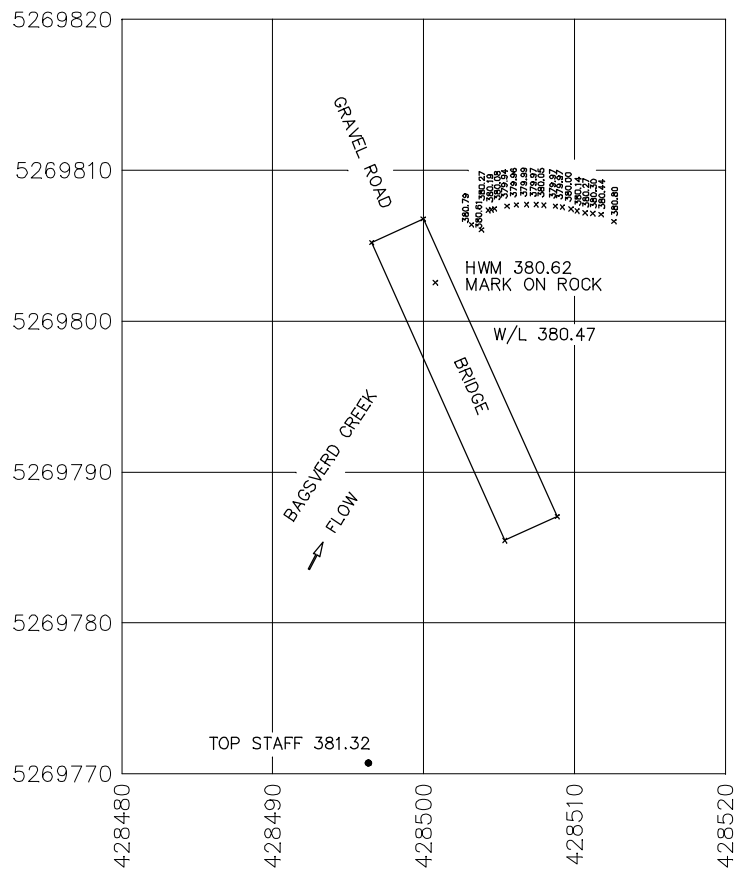

STAFF SL
428,496.35
5,269,770.72
381.32

PLAN SHOWING

DETAIL AT SITE SR

11 OCTOBER 2012

SCALE 1 : 500



↖ FLOW
SOMME RIVER

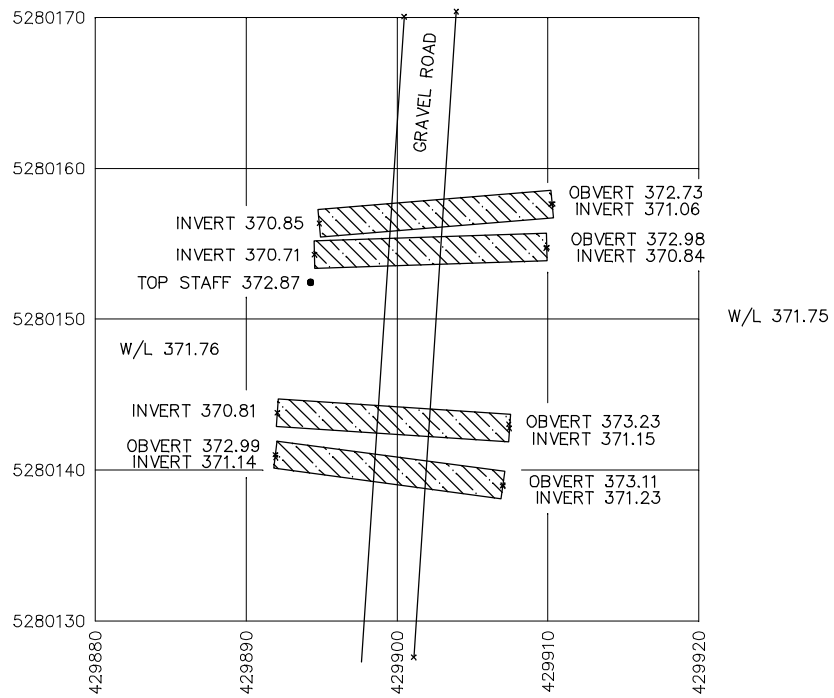

STAFF SR
429,894.26
5,280,152.44
372.87

4 CULVERTS 1.83 dia.



L. LABELLE SURVEYS
TIMMINS, ONTARIO
Phone/Fax (705) 268-8271



APPENDIX C

Bathymetric Maps

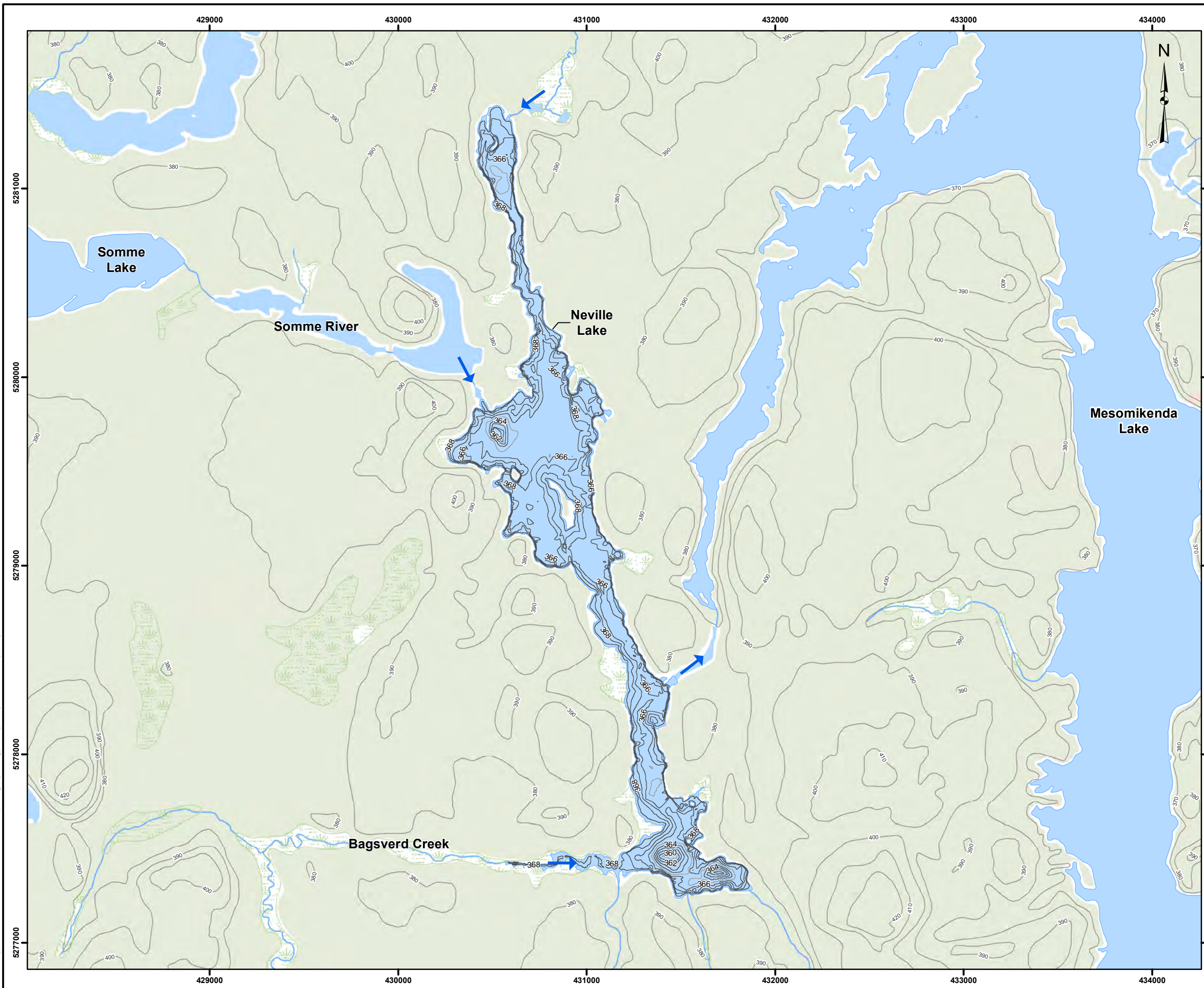

LEGEND

- Topographic Index Contours (10m interval)
- Bathymetric Index Contours (5m interval)
- Bathymetric Intermediate Contours (1m interval)
- Rivers
- Waterbodies
- Wetlands
- Wooded Areas

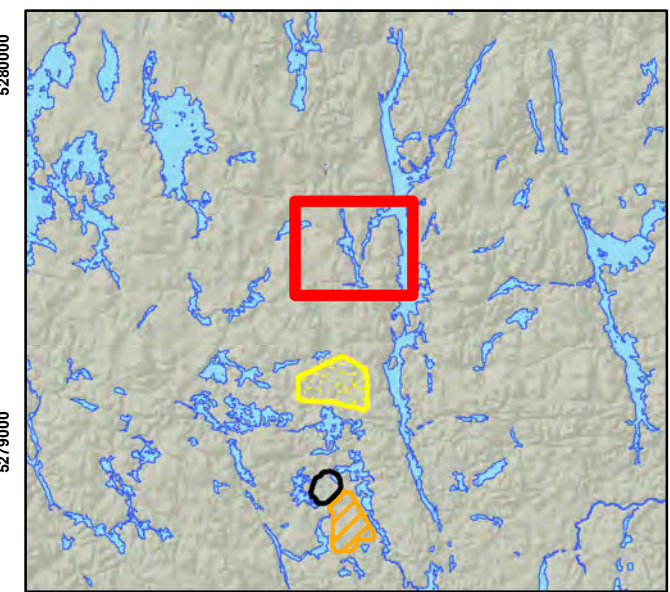

REFERENCE

Bathymetric data obtained by Golder Associates Ltd., 2013
 Contour Line captured via LiDAR- Aug. 31, 2011 (GeoDigital formerly Terrapoint)
 Base Data - MNR NRVIS, CANMAP v2008.4
 Produced by Golder Associates Ltd under licence from
 Ontario Ministry of Natural Resources, © Queens Printer 2013
 Projection: Transverse Mercator Datum: NAD 83 Coordinate System: UTM Zone 17

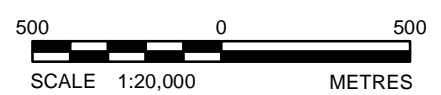

PROJECT		IAMGOLD CÔTÉ GOLD PROJECT	
TITLE			
Neville Lake Bathymetry			
<p>Golder Associates Sudbury, Ontario</p>	PROJECT No. 13-1192-0021		SCALE AS SHOWN
	DESIGN	AL	Sept. 2013
	GIS	AL	Oct. 2013
	CHECK	SK	Nov. 2013
	REVIEW	KAB	Nov. 2013
			REV. 0

FIGURE: 1

Path: Z:\Projects\2013113-1192-0021\GIS\MXDs\Reporting\Hydrology\Bathymetry\Unnamed_1_2_Bathymetry.mxd

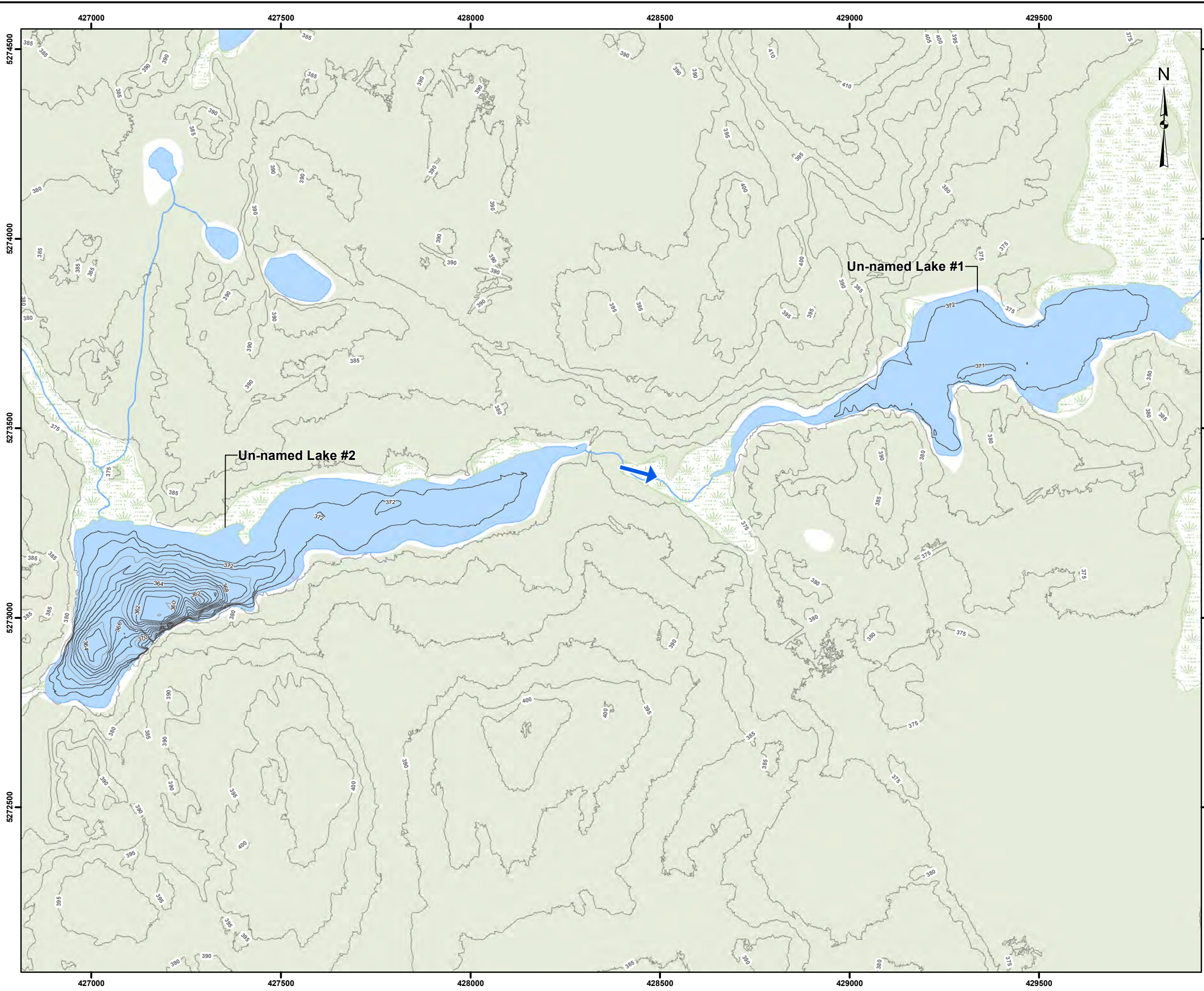

LEGEND

- Topographic Index Contours (5m interval)
- Bathymetric Index Contours (5m interval)
- Bathymetric Intermediate Contours (1m interval)
- Rivers
- Waterbodies
- Wetlands
- Wooded Areas

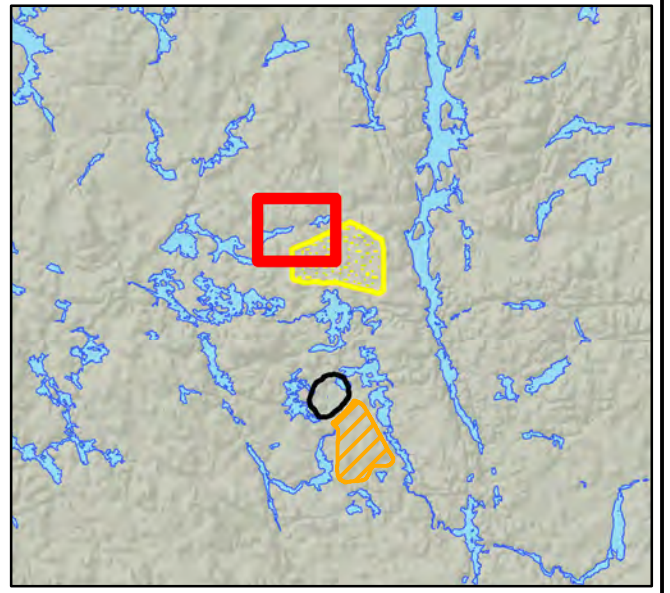

REFERENCE

Bathymetric data obtained by Golder Associates Ltd., 2013
 Contour Line captured via LIDAR- Aug. 31, 2011 (GeoDigital formerly Terrapoint)
 Base Data - MNR NRVIS, CANMAP v2008.4
 Produced by Golder Associates Ltd under licence from
 Ontario Ministry of Natural Resources, © Queens Printer 2013
 Projection: Transverse Mercator Datum: NAD 83 Coordinate System: UTM Zone 17

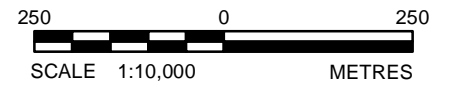

PROJECT		IAMGOLD CÔTÉ GOLD PROJECT	
TITLE			
Un-named Lake #1 and Un-named Lake #2 Bathymetry			
 Golder Associates Sudbury, Ontario	PROJECT No. 13-1192-0021	SCALE AS SHOWN	REV. 0
	DESIGN AL	Sept. 2013	FIGURE: 2
	GIS AL	Oct. 2013	
	CHECK SK	Nov. 2013	
REVIEW KAB	Nov. 2013		

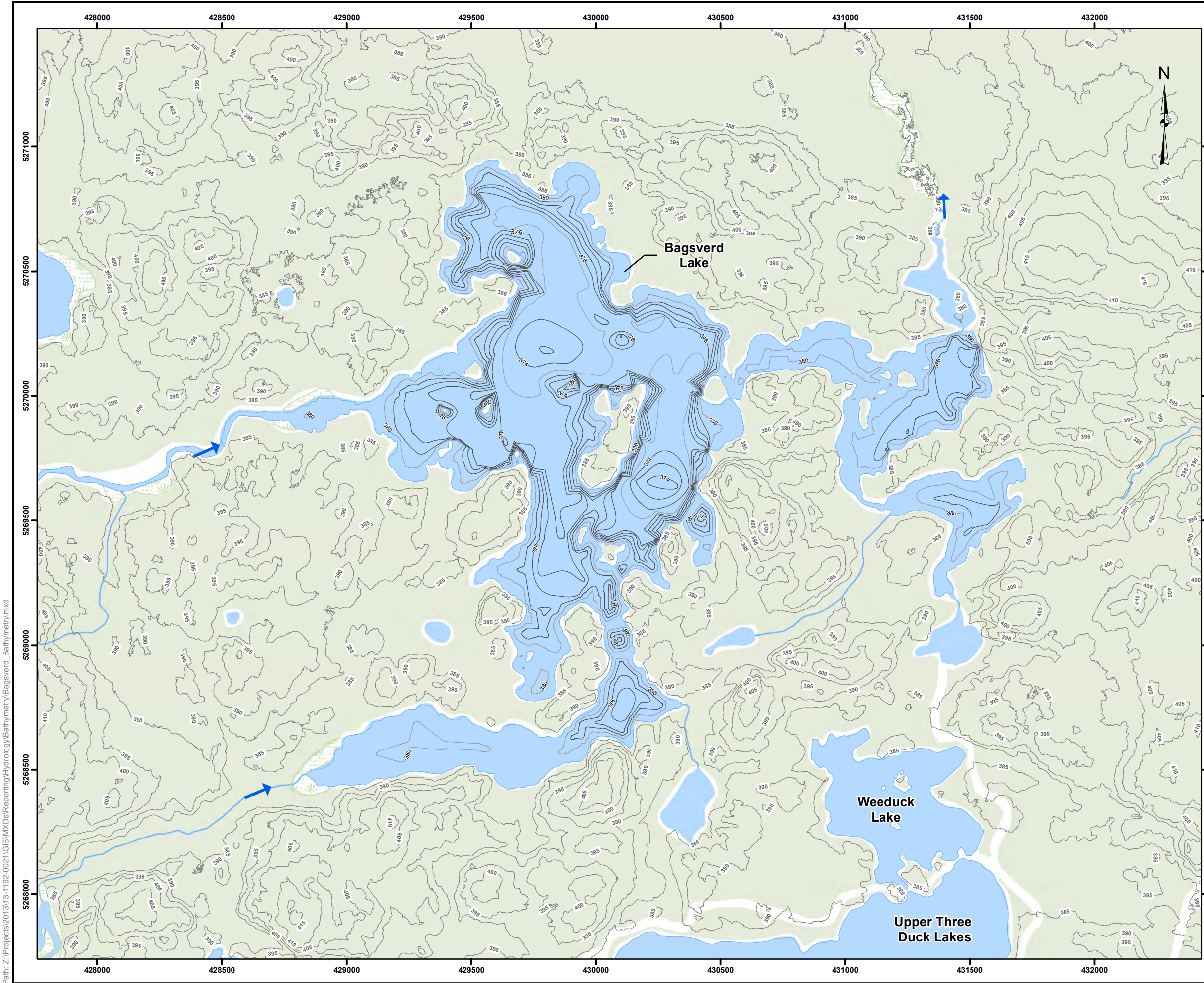

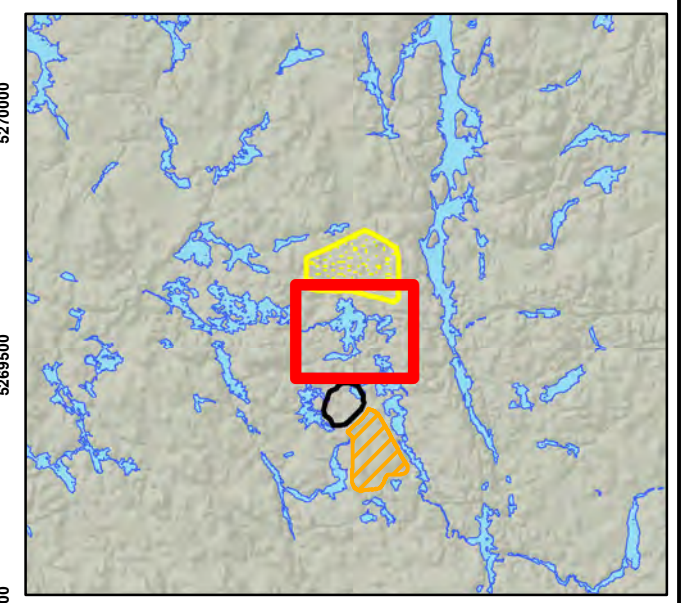

- LEGEND**
- Topographic Index Contours (5m interval)
 - Bathymetric Index Contours (5m interval)
 - Bathymetric Intermediate Contours (1m interval)
 - Rivers
 - Waterbodies
 - Wetlands
 - Wooded Areas

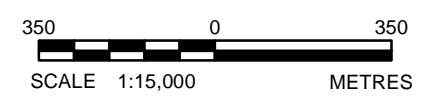

REFERENCE

Bathymetric data provided by IAMGOLD Corporation, 2012
 Contour Line captured via LiDAR- Aug. 31, 2011 (GeoDigital formerly Terrapoint)
 Base Data - MNR NRVIS, CANMAP v2008.4
 Produced by Golder Associates Ltd under licence from
 Ontario Ministry of Natural Resources, © Queens Printer 2013
 Projection: Transverse Mercator Datum: NAD 83 Coordinate System: UTM Zone 17



PROJECT		IAMGOLD CÔTÉ GOLD PROJECT	
TITLE			
Bagsverd Lake Bathymetry			
 Golder Associates Sudbury, Ontario	PROJECT No.	13-1192-0021	SCALE AS SHOWN
	DESIGN	AL Sept. 2013	REV. 0
	GIS	AL Oct. 2013	FIGURE: 3
	CHECK	SK Nov. 2013	
REVIEW	KAB Nov. 2013		

Path: Z:\Projects\2013\13-1192-0021\GIS\MXDs\Reporting\Hydrology\Bathymetry\Bagsverd_Bathymetry.mxd

Path: Z:\Projects\201313-1192-0021\GIS\MXDs\Reporting\Hydrology\Bathymetry\Delaney_Pond4_Bathymetry.mxd

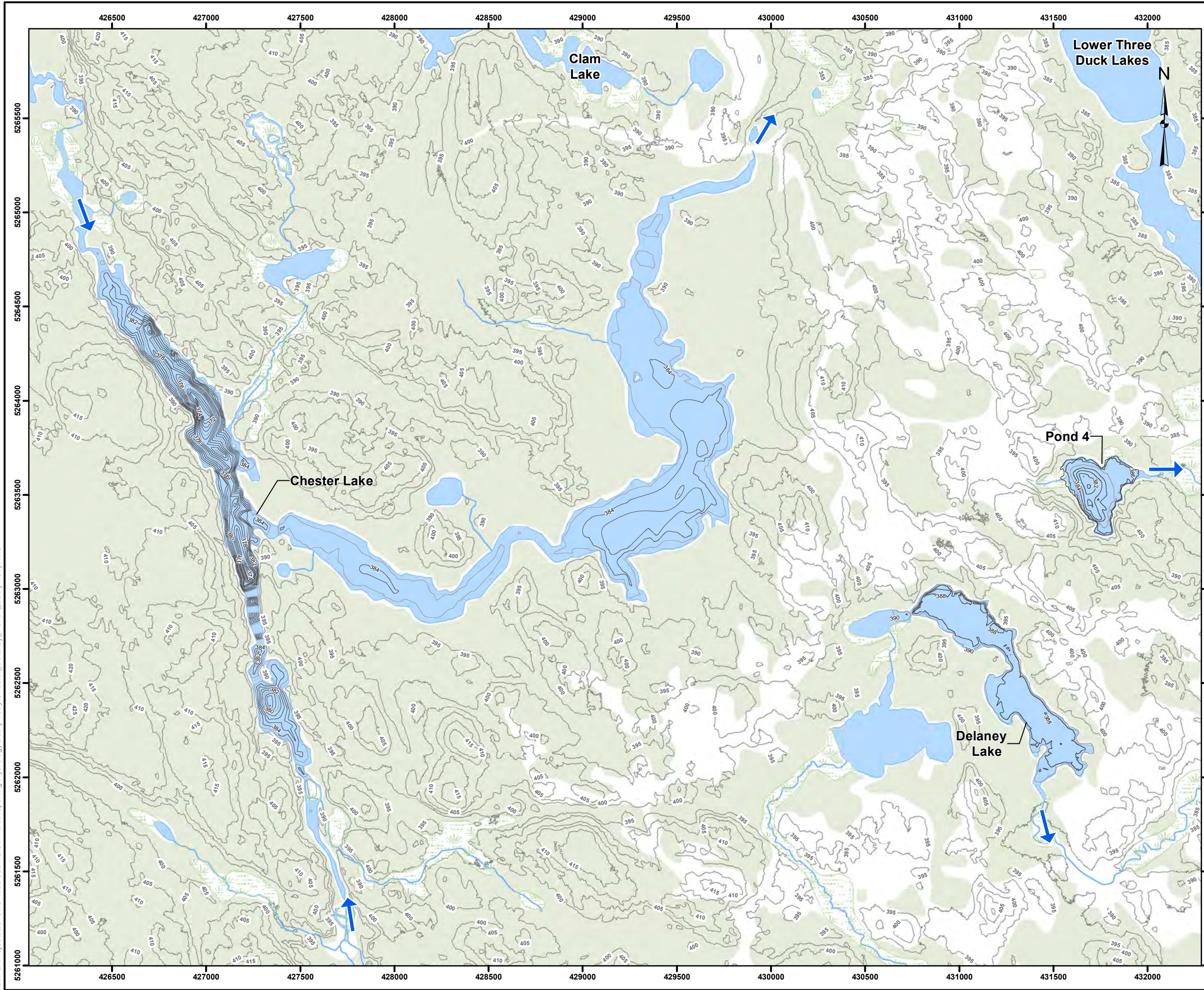

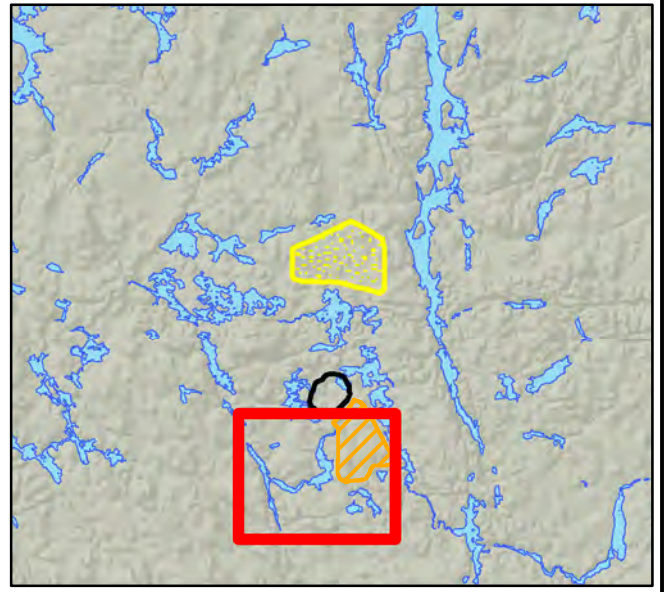

- LEGEND**
- Topographic Index Contours (5m interval)
 - Bathymetric Intermediate Contours (1m interval)
 - Bathymetric Index Contours (5m interval)
 - Rivers
 - Waterbodies
 - Wetlands
 - Wooded Areas

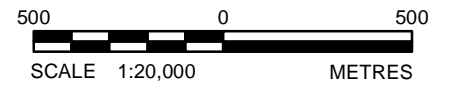

REFERENCE

Bathymetric data provided by IAMGOLD Corporation, 2012 and by Golder Associates Ltd., 2013
 Contour Line captured via LiDAR - Aug. 31, 2011 (GeoDigital formerly Terrapoint)
 Base Data - MNR NRVIS, CANMAP v2008.4
 Produced by Golder Associates Ltd under licence from Ontario Ministry of Natural Resources, © Queens Printer 2013
 Projection: Transverse Mercator Datum: NAD 83 Coordinate System: UTM Zone 17



PROJECT		IAMGOLD CÔTÉ GOLD PROJECT	
TITLE			
Chester Lake, Delaney Lake and Pond 4 Bathymetry			
 Golder Associates Sudbury, Ontario	PROJECT No. 13-1192-0021	SCALE AS SHOWN	REV. 0
	DESIGN	AL	Sept. 2013
	GIS	AL	Oct. 2013
	CHECK	SK	Nov. 2013
	REVIEW	KAB	Nov. 2013
			FIGURE: 4

Path: Z:\Projects\2013\13-1192-0021\GIS\MXDs\Reporting\Hydrology\Bathymetry\Clam_LittleClam_Cote_Bathymetry.mxd

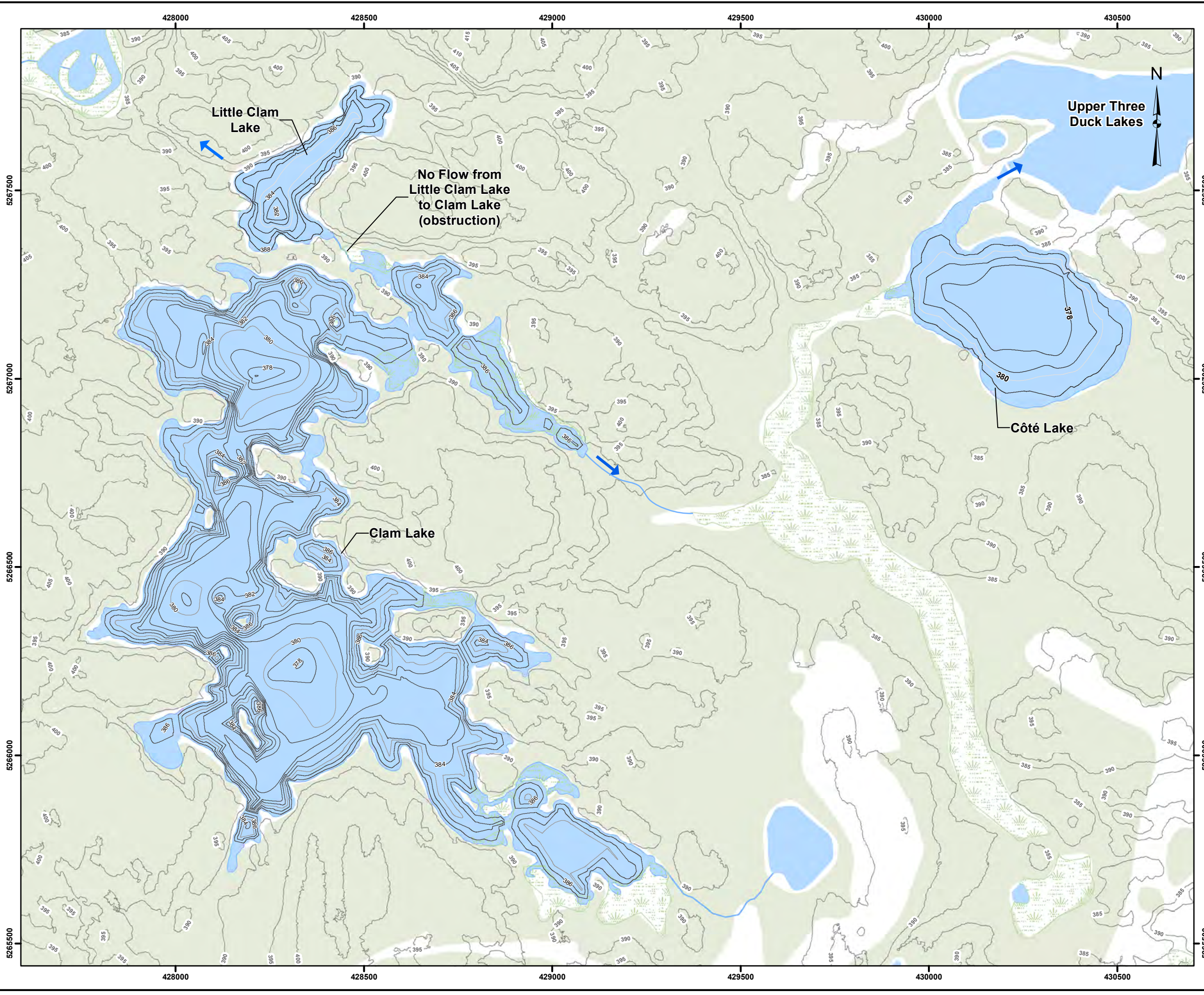

LEGEND

- Topographic Index Contours (5m interval)
- Bathymetric Intermediate Contours (1m interval)
- Bathymetric Index Contours (5m interval)
- Rivers
- Waterbodies
- Wetlands
- Wooded Areas

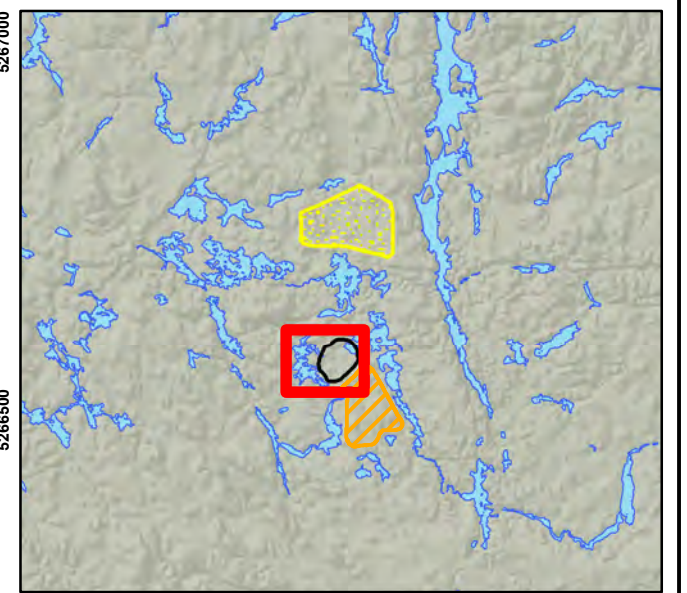

REFERENCE

Bathymetric data provided by IAMGOLD Corporation, 2012
 Contour Line captured via LiDAR- Aug. 31, 2011 (GeoDigital formerly Terrapoint)
 Base Data - MNR NRVIS, CANMAP v2008.4
 Produced by Golder Associates Ltd under licence from
 Ontario Ministry of Natural Resources, © Queens Printer 2013
 Projection: Transverse Mercator Datum: NAD 83 Coordinate System: UTM Zone 17

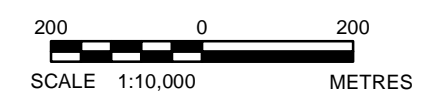

PROJECT		IAMGOLD CÔTÉ GOLD PROJECT	
TITLE		Clam Lake, Little Clam Lake and Côte Lake Bathymetry	
 Golder Associates Sudbury, Ontario	PROJECT No. 13-1192-0021	SCALE AS SHOWN	REV. 0
	DESIGN AL	Sept. 2013	FIGURE: 5
	GIS AL	Oct. 2013	
	CHECK SK	Nov. 2013	
REVIEW KAB	Nov. 2013		

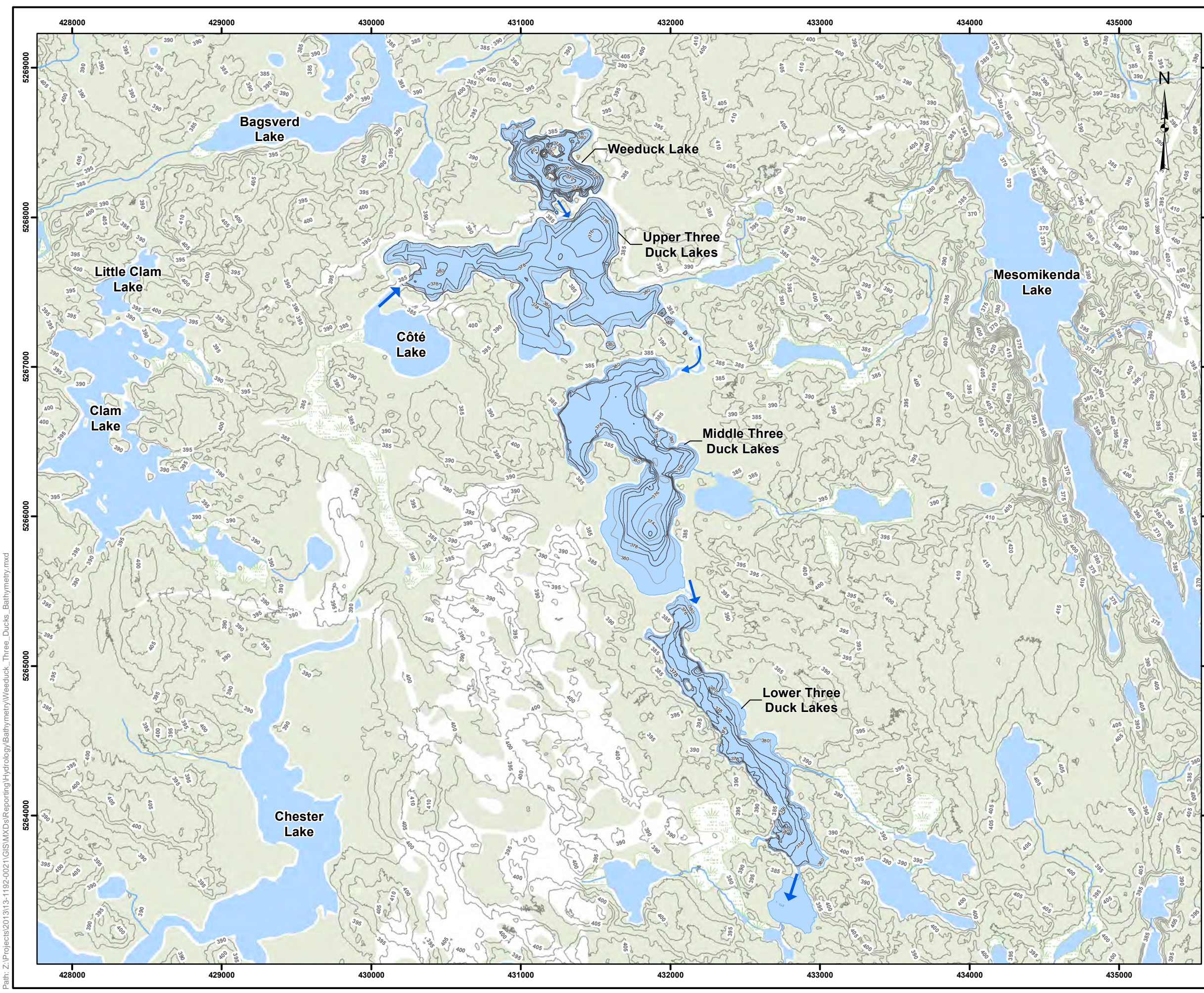

- LEGEND**
- Topographic Index Contours (5m interval)
 - Bathymetric Index Contours (5m interval)
 - Bathymetric Intermediate Contours (1m interval)
 - Rivers
 - Waterbodies
 - Wetlands
 - Wooded Areas

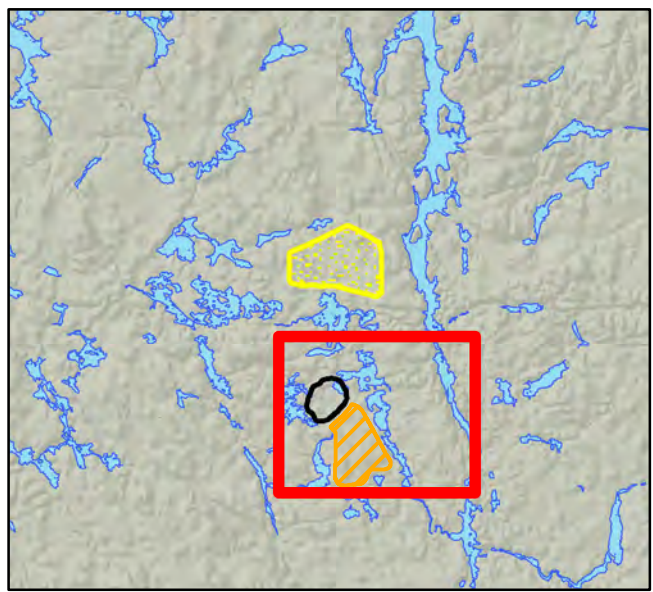

REFERENCE

Bathymetric data provided by IAMGOLD Corporation, 2012 and by Golder Associates Ltd., 2013
 Contour Line captured via LiDAR- Aug. 31, 2011 (GeoDigital formerly Terrapoint)
 Base Data - MNR NRVIS, CANMAP v2008.4
 Produced by Golder Associates Ltd under licence from Ontario Ministry of Natural Resources, © Queens Printer 2013
 Projection: Transverse Mercator Datum: NAD 83 Coordinate System: UTM Zone 17

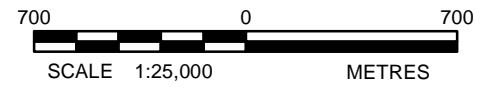

PROJECT		IAMGOLD CÔTÉ GOLD PROJECT	
TITLE			
Weeduck and Three Duck Lakes Bathymetry			
 Golder Associates Sudbury, Ontario	PROJECT No. 13-1192-0021	SCALE AS SHOWN	REV. 0
	DESIGN AL	Sept. 2013	FIGURE: 6
	GIS AL	Oct. 2013	
	CHECK SK	Nov. 2013	
REVIEW KAB	Nov. 2013		

Path: Z:\Projects\2013113-1192-0021\GIS\MXDs\Reporting\Hydrology\Bathymetry\Weeduck_Three_Ducks_Bathymetry.mxd

Path: Z:\Projects\2013113-1192-0021\GIS\MXDs\Reporting\Hydrology\Bathymetry\Mesomikenda_top_Bathymetry.mxd

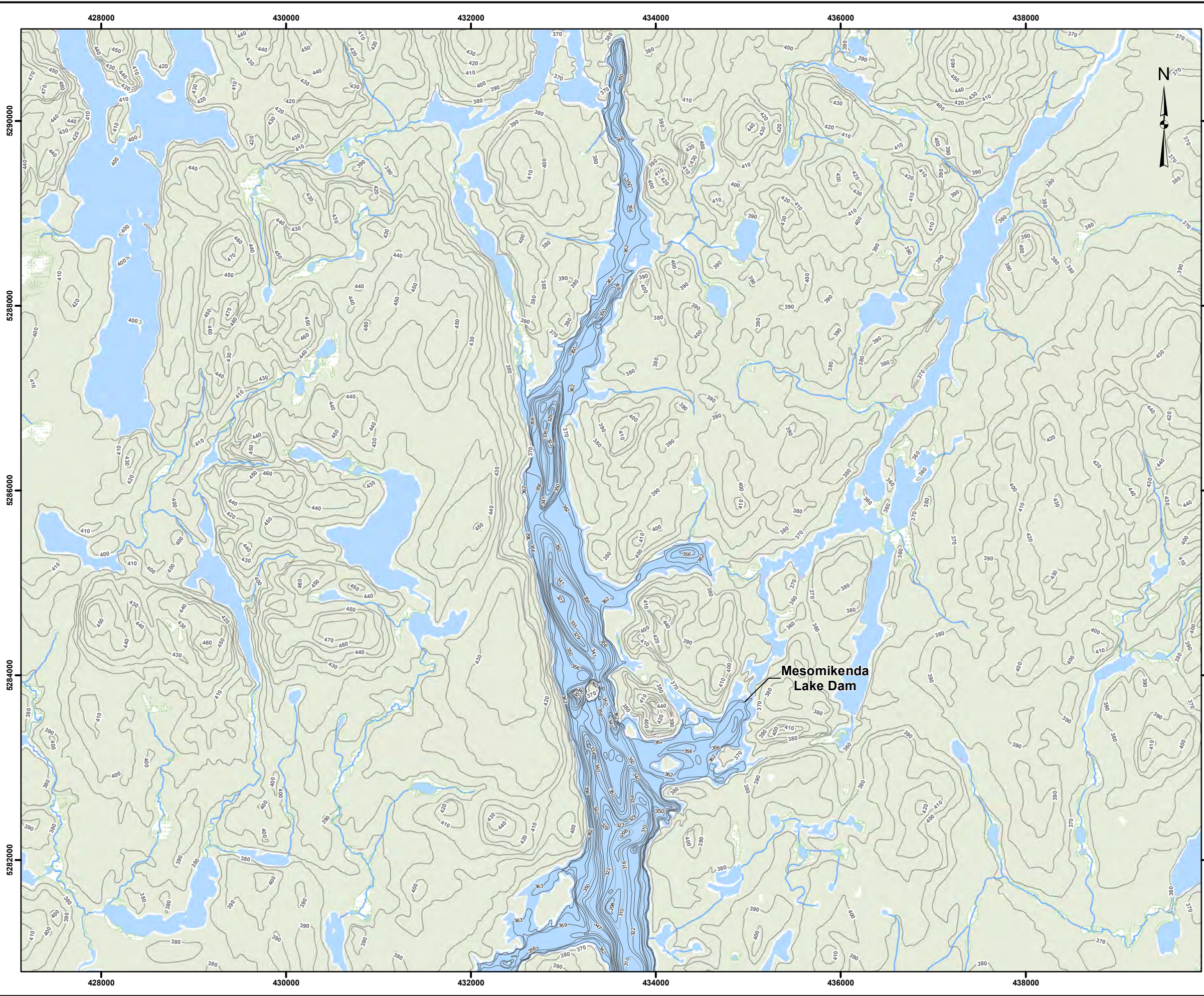

- LEGEND**
- Topographic Index Contours (10m interval)
 - Bathymetric Index Contours (5m interval)
 - Bathymetric Intermediate Contours (1m interval)
 - Rivers
 - Waterbodies
 - Wetlands
 - Wooded Areas

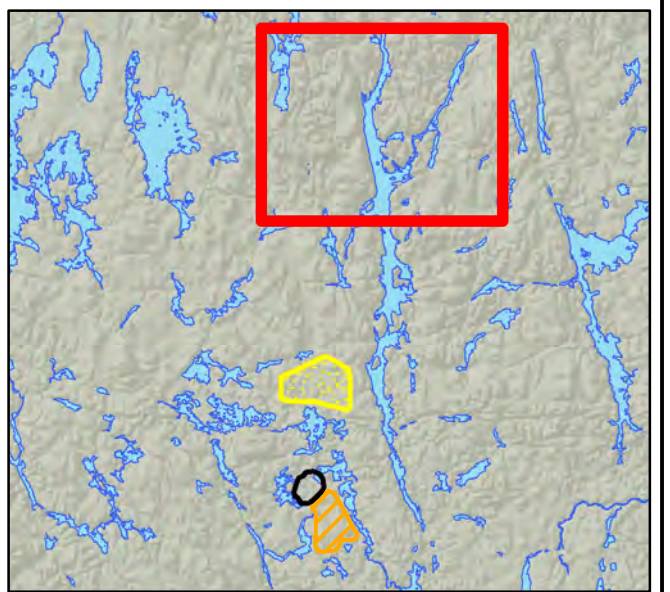

REFERENCE

Bathymetric data provided by IAMGOLD Corporation, 2012
 Base Data - MNR NRVIS, CANMAP v2008.4
 Produced by Golder Associates Ltd under licence from
 Ontario Ministry of Natural Resources, © Queens Printer 2013
 Projection: Transverse Mercator Datum: NAD 83 Coordinate System: UTM Zone 17

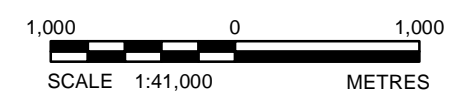

PROJECT		CÔTÉ GOLD PROJECT	
TITLE			
Mesomikenda Lake Bathymetry (Upper)			
 Sudbury, Ontario	PROJECT No.	13-1192-0021	SCALE AS SHOWN
	DESIGN	AL Sept. 2013	REV. 0
	GIS	AL Oct. 2013	FIGURE: 7
	CHECK	SK Nov. 2013	
REVIEW	KAB Nov. 2013		

Path: Z:\Projects\2013113-1192-0021\GIS\MXDs\Reporting\Hydrology\MesomikendamiddleBathymetry.mxd

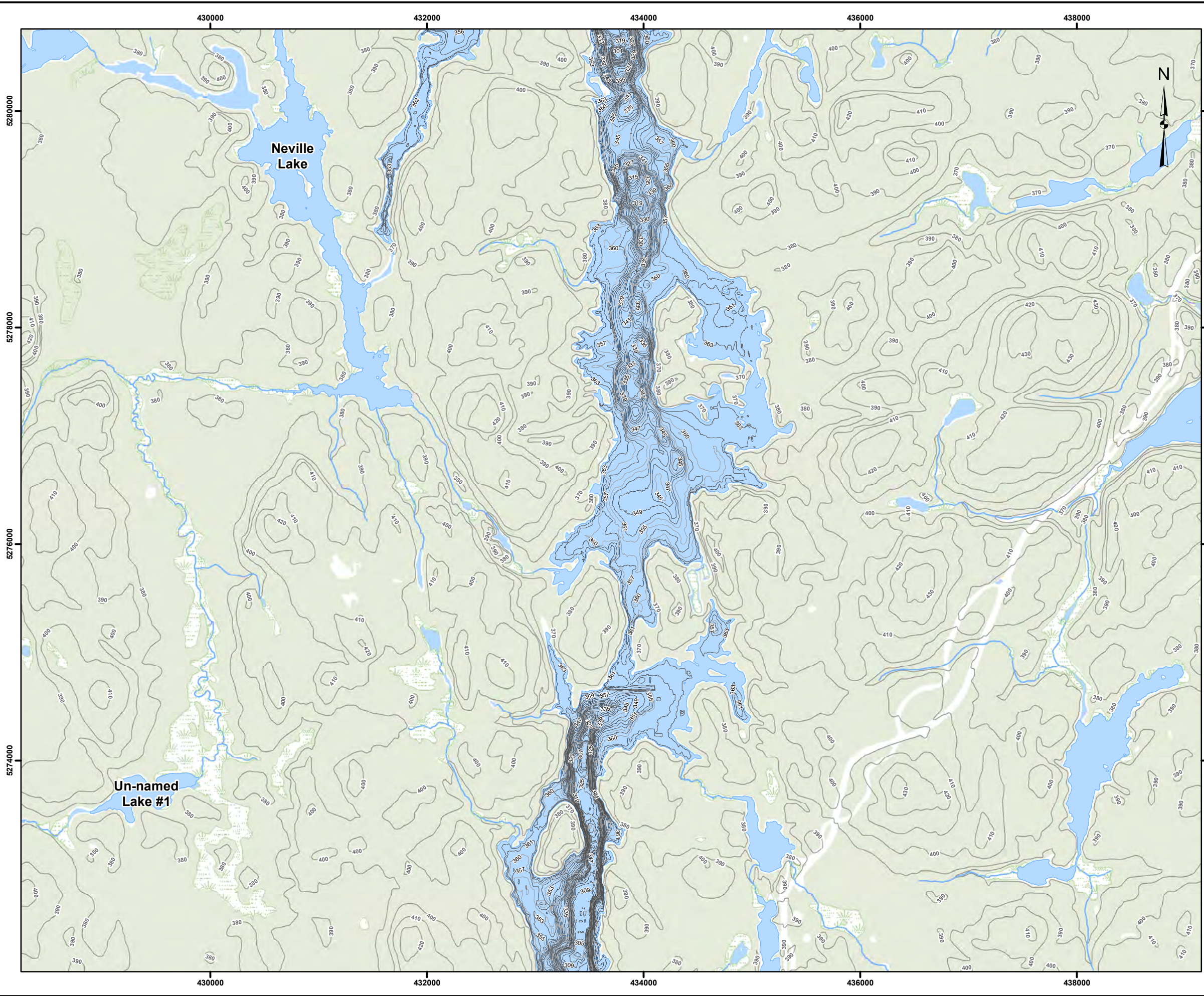

- LEGEND**
- Topographic Index Contours (10m interval)
 - Bathymetric Index Contour (5m interval)
 - Bathymetric Intermediate Contour (1m interval)
 - Rivers
 - Waterbodies
 - Wetlands
 - Wooded Areas

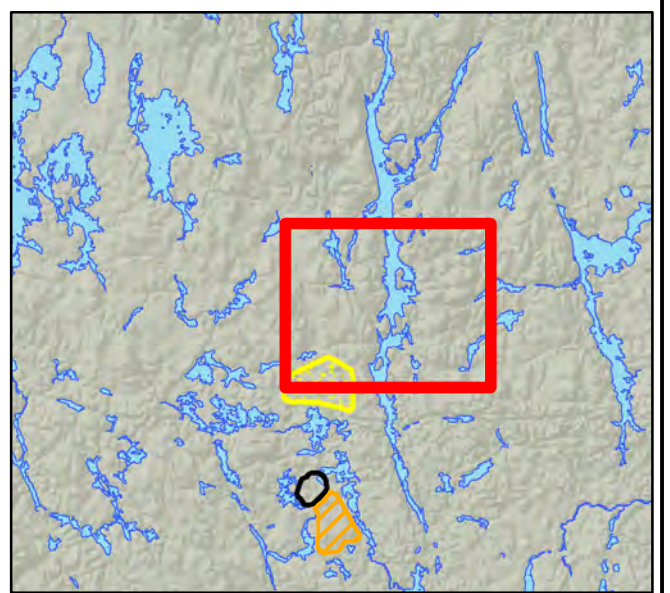

REFERENCE

Bathymetric data provided by IAMGOLD Corporation, 2012
 Base Data - MNR NRVIS, CANMAP v2008.4
 Produced by Golder Associates Ltd under licence from
 Ontario Ministry of Natural Resources, © Queens Printer 2013
 Projection: Transverse Mercator Datum: NAD 83 Coordinate System: UTM Zone 17



PROJECT		IAMGOLD CÔTÉ GOLD PROJECT	
TITLE			
Mesomikenda Lake Bathymetry (Middle)			
 Golder Associates Sudbury, Ontario	PROJECT No.	13-1192-0021	SCALE AS SHOWN
	DESIGN	AL Sept. 2013	REV. 0
	GIS	AL Oct. 2013	FIGURE: 8
	CHECK	SK Nov. 2013	
REVIEW	KAB Nov. 2013		

Path: Z:\Projects\2013113-1192-0021\GIS\MXDs\Reporting\Hydrology\Bathymetry\Mesomikenda_bottom_Bathymetry.mxd

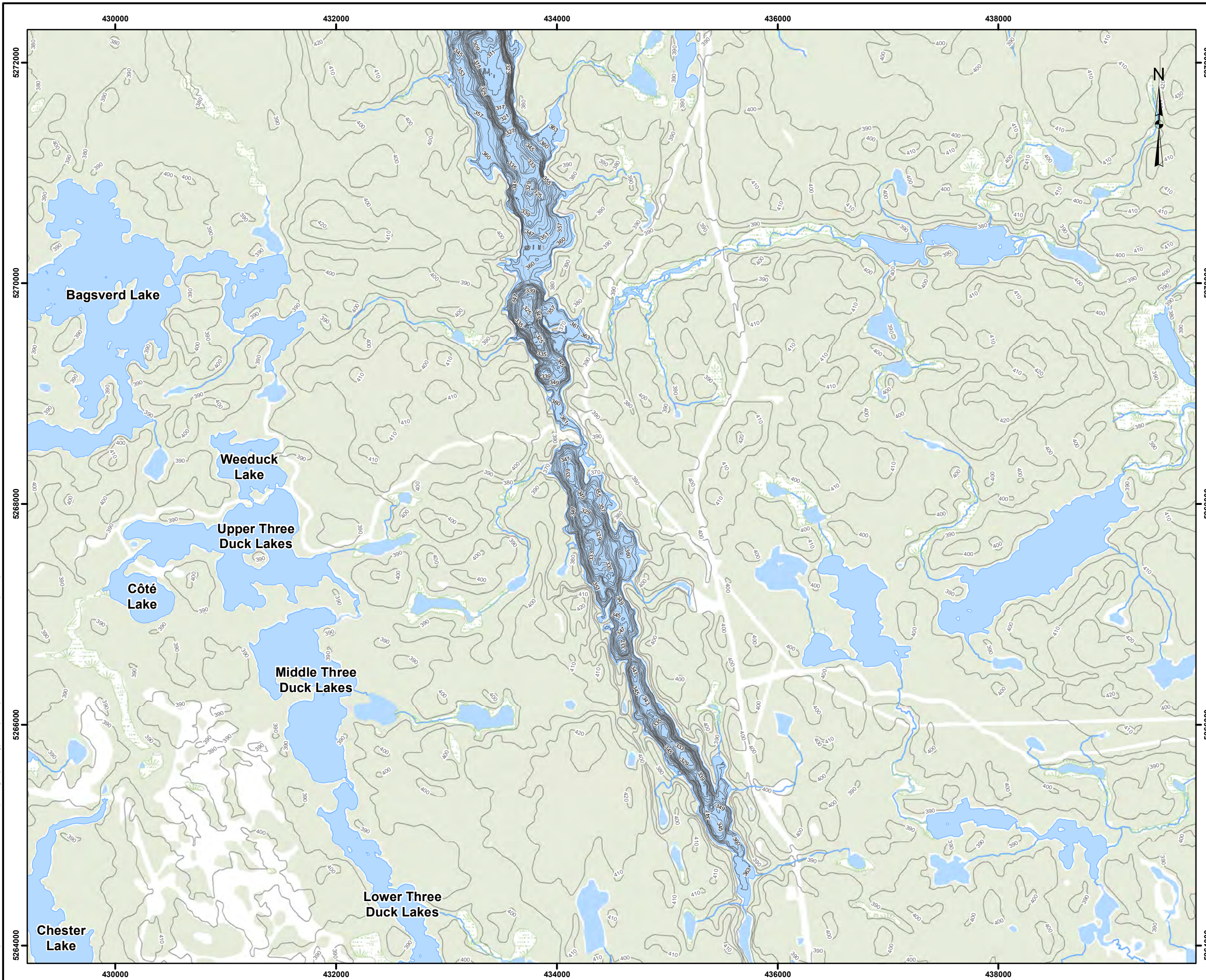

LEGEND

- Topographic Index Contours (10m interval)
- Bathymetric Index Contours (5m interval)
- Bathymetric Intermediate Contours (1m interval)
- Rivers
- Waterbodies
- Wetlands
- Wooded Areas

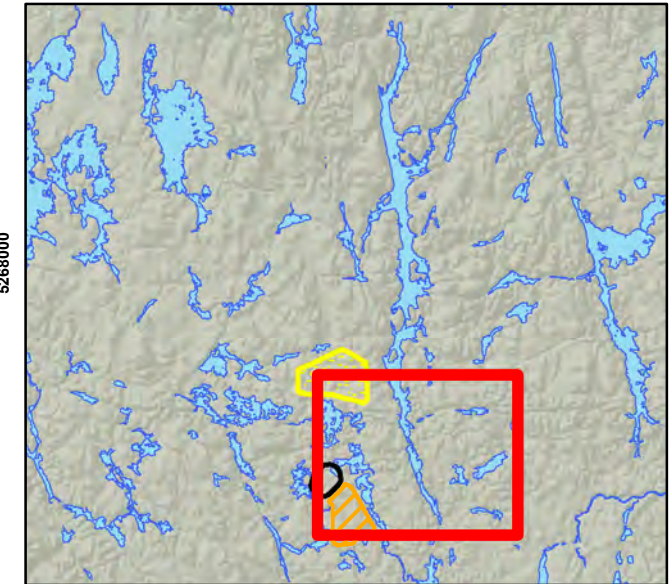

REFERENCE

Bathymetric data provided by IAMGOLD Corporation, 2012
 Base Data - MNR NRVIS, CANMAP v2008.4
 Produced by Golder Associates Ltd under licence from
 Ontario Ministry of Natural Resources, © Queens Printer 2013
 Projection: Transverse Mercator Datum: NAD 83 Coordinate System: UTM Zone 17

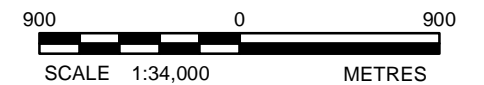

PROJECT		IAMGOLD CÔTÉ GOLD PROJECT	
TITLE		Mesomikenda Lake Bathymetry (Lower)	
Golder Associates Sudbury, Ontario	PROJECT No. 13-1192-0021	SCALE AS SHOWN	REV. 0
	DESIGN AL	Sept. 2013	FIGURE: 9
	GIS AL	Oct. 2013	
	CHECK SK	Nov. 2013	
	REVIEW KAB	Nov. 2013	



ATTACHMENT II

Hydrological Modelling Report, Côté Gold Project



October 30, 2014

IAMGOLD CORPORATION

Hydrological Modelling Report Côte Gold Project

Submitted to:
IAMGOLD Corporation
upload to buzzsaw

REVISED REPORT

Report Number: 13-1192-0021 (1000/1040)R

Distribution:

1 e-copy - IAMGOLD Corporation
3 copies - Golder Associates Ltd.





Table of Contents

1.0 INTRODUCTION..... 1

2.0 BACKGROUND..... 1

 2.1 Objectives..... 2

3.0 METHODOLOGY..... 2

 3.1 Watershed Delineation and Land Cover 3

 3.2 Water Balance Elements and Hydrological Model Structure 3

 3.2.1 Precipitation 4

 3.2.2 Catchment Evapotranspiration and Reservoir Evaporation..... 5

 3.2.3 Surface Water Inflow 5

 3.2.4 Surface Water Outflow 5

 3.2.5 Water Level and Change in Storage 6

 3.2.6 Groundwater Inflow and Groundwater Outflow 6

 3.2.7 Process Water Flows 6

 3.3 Model Phases..... 8

 3.3.1 Existing Conditions..... 8

 3.3.2 Operational Phase 9

 3.3.3 Post-Closure Phase Stage I..... 9

 3.3.4 Post-Closure Phase Stage II..... 9

 3.4 Assumptions and Limitations 9

4.0 MODEL VERIFICATION 10

5.0 RESULTS 10

 5.1 Climate 10

 5.2 Hydrological Output 11

6.0 CONCLUSIONS..... 11

7.0 REFERENCES..... 12



TABLES

Table 1: Process Water Flow Paths	6
Table 2: Estimated Processing Rates	8
Table 3: Climate Summary	11

FIGURES

Figure 1: Project Location
Figure 2: Site Plan
Figure 3: Existing Conditions Watersheds
Figure 4: Existing Conditions Flow Schematic
Figure 5: Operations Phase Post-Closure Stage I Watersheds
Figure 6: Operations Phase Flow Schematic
Figure 7: Post-Closure Phase Stage I Flow Schematic
Figure 8: Post-Closure Phase Stage II Watersheds
Figure 9: Post-Closure Phase Stage II Flow Schematic
Figure 10: GoldSim Model Verification – Mollie River
Figure 11: GoldSim Model Verification – Mesomikenda Lake
Figure 12: Simulated Monthly Total Precipitation

APPENDICES

APPENDIX A

Low Flow Statistics

APPENDIX B

Simulated Monthly Climate

APPENDIX C

Hydrological Model Output



1.0 INTRODUCTION

Golder Associates Ltd. (Golder) was retained by IAMGOLD Corporation (IAMGOLD) to complete a hydrological model for the Côté Gold Project Site (the Project) located in the townships of Neville and Chester, near the town of Gogama, Ontario (Figure 1). The following report summarizes the development and results of a hydrological model constructed to estimate surface water responses to various climatic conditions and project development and rehabilitation phases. The modelling results were subsequently used as a basis for assessing potential changes to the hydrological system as a consequence of the project. This same model was thereafter used to support development of predictions of changes in water quality in the receiving environment.

2.0 BACKGROUND

Hydrological field studies at the Project have been underway from approximately 2011. These studies were initiated by others and Golder was retained to review, update and continue these studies in the spring of 2012. Hydrological stations (automatic water level recorders and manual streamflow measurements) were installed in 2012 on key waterways around the Project. The purpose of these installations was to characterize the seasonal flow regimes in lakes and streams and to develop a conceptual model of surface water dynamics under existing climate and watershed configuration conditions. The field program is detailed in Golder (2013a).

IAMGOLD proposes to construct, operate and eventually rehabilitate a new open pit gold mine and ore processing facility with associated infrastructure. Briefly, the Project components and associated activities include:

- blasting, excavation and dewatering of a 550 metre (m) deep open pit mine;
- development of a 450 ha mine rock disposal area (MRA) and associated perimeter runoff and seepage collection facilities;
- temporary storage of low grade ore (low-grade stockpile) located to the northeast of the pit;
- development of a 840 hectare (ha) tailings management facility (TMF), polishing pond and associated perimeter runoff and seepage collection facilities;
- ore beneficiation and discharge of water from the processing plant to the TMF;
- management of site runoff and seepage through the use of collection ponds and a mine water pond located adjacent to the processing plant;
- realignment of various surface water features and construction of associated dams; and
- a low-grade ore stockpile.

The key Project components are presented in Figure 2.

In order to estimate the hydrological response to these infrastructure components in the context of the variability observed in the field program, a hydrological model was developed that was capable of:



- 1) Estimating rainfall/snowmelt and runoff response in watersheds of the Project.
- 2) Estimating the variation in runoff response under various climatic conditions not necessarily observed in the duration of the field program.
- 3) Incorporating process water demand and discharge.
- 4) Estimating the change in streamflow and water level resulting from site development and closure activities.

In addition, the model was applied to each of the following project phases:

- 1) Existing Conditions – with the currently observed surface water flowpaths.
- 2) Operations Phase – with the Project developed to its maximum footprint.
- 3) Post-Closure Phase Stage I – with initial closure activities and pit flooding underway.
- 4) Post-Closure Phase Stage II – with the Project after rehabilitation activities are complete and the pit has flooded.

These project phases are described in additional detail in Section 3.3

2.1 Objectives

The specific objectives of the modelling program were to simulate the hydrological system at the Project under current conditions as well as those that result from the development of the Côté Gold project under a range of climate conditions.

3.0 METHODOLOGY

A hydrological model was developed for the Project using GoldSim (GoldSim 2013). GoldSim is a dynamic object-oriented modelling package that can be applied to simulate water flows through watersheds, hydraulic structures and storage features (lakes or reservoirs) by developing user-defined relationships between storage and water transfer. The model development for the Project required inputs of:

- watershed area;
- land cover type;
- climate (precipitation, evapotranspiration);
- lake outflow or stream discharge controls;
- lake or reservoir volume;
- groundwater flow; and
- process water flows.



Watersheds in each model were linked sequentially based on the flow regime dictated by the Project Phase (Section 3.3). The inflow and outflow of each study watershed was then calculated at a daily time step and summarized annually for selected wet, dry and average climate conditions.

3.1 Watershed Delineation and Land Cover

Watershed area and land cover type for each studied lake and project Phase were estimated using Geographic Information Systems (GIS) software and the following information:

- LiDAR topographic surveys (provided by IAMGOLD);
- Land Cover (Spectranalysis 2004);
- infrastructure and stream and dam realignment plans (provided by IAMGOLD and Calder Engineering, respectively);
- Ontario Base Mapping; and
- in-field reconnaissance.

Land cover was directly related to the assigned Water Holding Content (WHC) of each watershed (i.e., the soil storage available in a watershed as described in Section 3.2.3).

3.2 Water Balance Elements and Hydrological Model Structure

A water balance quantifies the inputs, outputs and storage changes integrated over an area. Over long periods of time (e.g., annually) storage changes become negligible and the inputs to the budget are equal to the outputs. For the Project, the water balance can be described as in equation (1):

$$\Delta S = P + Q_{S_IN} + Q_{G_IN} + Q_{P_IN} - ET - Q_{S_OUT} - Q_{G_OUT} - Q_{P_OUT} \quad (1)$$

where ΔS is change in storage, P is total precipitation, Q_{S_IN} is surface water input (the sum of catchment runoff and flow from upstream reservoirs), Q_{G_IN} is groundwater input, Q_{P_IN} is process water input, Q_{S_OUT} is surface water output, Q_{G_OUT} is groundwater output and Q_{P_OUT} is process water outflow. Evapotranspiration (ET) occurs at its potential rate (PET) when water is freely available and the evaporating air mass is stable. Over the course of a month or day these terms vary in their contributions to change in storage (ΔS), which is reflected in either a change in soil moisture conditions, or as a change in surface water level. Surface water flow is reported herein as m^3/day .



Equation (1) was used to estimate surface water flow (Q_{S_OUT} ; Q_{S_IN}) and water level (ΔS) in the lakes and reservoirs of the Project. Detailed description of water balance inputs follow, and the general model procedure applied for the Côté Gold GoldSim model was as follows:

- 1) Soil WHC was estimated by weighting land cover type over each watershed by area (Section 3.2.3).
- 2) Precipitation (P) was applied to the watershed as rainfall or snowfall, on a daily basis. Snowmelt was estimated using a temperature index equation (Section 3.2.1).
- 3) PET was estimated using the Thornthwaite temperature index model as described in Section 3.2.2 (Thornthwaite and Mather 1957). If $P > PET$, the water surplus (water available as runoff) was calculated as $P - PET$. If $P < PET$, water was removed from soil storage to satisfy evaporative demand.
- 4) If a water surplus was predicted when $P - PET > 0$, water was first used to fill soil water storage to the assigned watershed WHC. If soil WHC was at its maximum, the remaining water was assigned as watershed runoff and directed to the downstream watershed receiver (stream, lake or reservoir).
- 5) Process water inflows (Q_{P_IN}) and removals (Q_{P_OUT}) were incorporated to the water balance for the as required during specific project phases, as described in Golder 2013b.

3.2.1 Precipitation

In order to associate the project Phases with climatic variability, a precipitation record for the Project was estimated by using the on-site meteorological tower (installed in May 2012) and four regional climate stations (at Chapleau, Timmins, North Bay and Sudbury; detailed in Golder 2013a). The regional data was used to gap-fill the on-site precipitation data and to assemble a Project estimated daily precipitation for the period 1970-2012 (43 years).

Statistics for the Project were compiled from this dataset to estimate return periods for precipitation using a Log Pearson III distribution. Given the estimated life of mine (15 years), an annual precipitation return period of 25 years was considered representative of the potential variation in climate. As such, the 1:25-year precipitation statistics were defined as wet and dry conditions for this study.

From these statistics, representative years from the assembled on-site record were selected for 1:25-year wet, 1:25-year dry and average annual precipitation conditions.

Total precipitation was simulated as rainfall when the daily average temperature was above 0°C and as snowfall when daily average temperature was below 0°C. Snowmelt was estimated using the temperature index method as described by Pysklywec et al. 1968.



3.2.2 Catchment Evapotranspiration and Reservoir Evaporation

The Thornthwaite *PET* heat index method (Thornthwaite and Mather 1957) was used to estimate evapotranspiration over each study watershed and open water evaporation over the various reservoirs. Evapotranspiration was simulated on days which exceeded an average daily temperature of 0°C.

Temperature for the Project was estimated similarly to precipitation, however only the regional climate stations at Sudbury and Timmins were used along with on-site data to determine a latitudinal gradient in air temperature. This allowed for extrapolation of a daily temperature record for the Project for the period 1970 to 2012.

During winter months, sublimation was simulated in order to estimate water loss when wind and solar conditions allow the snowpack to be converted directly to water vapour; in turn this can decrease snowpack and snow water content. An average sublimation rate was estimated at 0.3 mm/day, based on sublimation studies in the region (Pejam et al. 2006).

3.2.3 Surface Water Inflow

Surface water inflow was calculated from i) runoff when P exceeded PET , ii) runoff when $P + \text{snowmelt}$ exceeded PET and iii) discharge from upstream watersheds.

Runoff from land surface to surface water features was initiated once the water holding content (WHC) of the contributing watershed was exceeded. WHC was assigned to each land cover type and was weighted to the proportion of land cover in each watershed. In this respect, WHC acted as a reservoir that allowed for extraction of moisture to satisfy PET and soil moisture change in the studied watersheds. No watershed lag time was applied to runoff; when $P - PET$ or $P + \text{snowmelt}$ exceeded WHC, runoff was directed to the downstream surface water feature on the same timestep in which it occurred.

For consistency with Golder (2013b), footprints associated with infrastructure were assigned an annual average runoff ratio, which represented the proportions of precipitation that resulted in runoff and/or interflow. At the MRA, precipitation was partitioned to runoff or infiltration, which allowed for both rapid (runoff) and delayed (toe seepage from infiltrated water) inflows to the perimeter collection ponds.

3.2.4 Surface Water Outflow

Outflows for the natural surface water regime (lakes and streams) were estimated using:

- 1) Rating Curves – as developed at key flow monitoring sites across the Project (Golder 2013a).
- 2) Operating Rules – as indicated in Mesomikenda Lake (Golder 2013a).
- 3) Stage – Storage (Lake Bathymetry) – as estimated from bathymetric surveys where rating curves were not developed; lakes were assumed to fill to a given storage and subsequently discharge.
- 4) Realignment Details – Rating curves were developed from estimated dimensions of realignment features provided by Calder Engineering (Calder Engineering 2012).



As is typical for northern Ontario, baseflow in the waterways of the Project are likely provided by groundwater as well as delayed surface water inflows (from numerous upstream lakes and wetlands). The period of observed discharge at the Project (approximately one year) was considered insufficient to complete baseflow separations. As such, baseflow was estimated as the average annual 30-day low flow (30Q₂). According to Pyrcce (2004), the 30Q₂ can provide a reasonable estimate of the typical low flow (baseflow) conditions in a watershed.

The 30Q₂ for the studied watersheds of the Project were pro-rated from regional WSC stations that had a period of record of at least 20 years, which allowed for comparison to other available low flow metrics, such as the unit flow for the seven day low flow period with a 20-year return period (7Q₂₀; Cumming Cockburn 1995). In the hydrological model, the 30Q₂ was applied at lake outflows, which simulated low flow contribution to downstream watersheds. Estimated 30Q₂ for regional stations and the Project are tabulated in Appendix A.

3.2.5 Water Level and Change in Storage

Lake storage change (ΔS) was estimated through bathymetric and topographic data provided by IAMGOLD was supplemented with data collected by Golder in 2013, where applicable. Lake storage was related to water level through topographic data and the installation and survey of staff gauges (Golder 2013a). Mesomikenda Lake was separated into four basins ('lower', 'middle', 'upper/middle' and 'upper' basins) in order to refine the movement of water through the water body.

3.2.6 Groundwater Inflow and Groundwater Outflow

Groundwater fluxes (Q_{G_IN} and Q_{G_OUT}) are presented in Golder (2013c). These flows through dam features and inflow to the open pit were incorporated into specific project phases (Section 3.3).

3.2.7 Process Water Flows

Process water flows include those water flows directed from one infrastructure location to another, or ultimately to the downstream environment. The identified process water sources and sinks for the Project as described in Golder 2012b are summarized in Table 1.

Table 1: Process Water Flow Paths

Water Source	Water Sink	Notes
Freshwater (Mesomikenda Lake)	Process Plant	Freshwater is required in the Process Plant
Open Pit	Mine Water Pond	Includes groundwater inflow and direct precipitation; assumed inflow was pumped to the mine water pond at the rate at which it entered the Open Pit
Seepage Collection Ponds	Mine Water Pond	Located at the Ore Stockpile (4 ponds) and Mine Rock Area (15 ponds). Mine Rock Area maintains a seasonal pumping schedule for ponds not adjacent to the Open Pit



Water Source	Water Sink	Notes
Process Plant	Tailings Management Facility Reclaim Pond	Tailings slurry discharged at approximately 50% solids
Process Plant, Open Pit watersheds	Mine Water Pond	Includes the watershed inside the planned realignment dams and the area that drains towards Côté Lake.
Tailings Management Facility Reclaim Pond	Process Plant	Tailings slurry supernatant water is recycled
Polishing Pond	Process Plant	Reclaim water
Mine Water Pond	Polishing Pond	Water in the Mine Water Pond will be used for process when insufficient water is available at the TMF Reclaim Pond
Polishing Pond	TMF Reclaim Pond	As required, to take advantage of storage capacity in TMF.
Polishing Pond	Environment	As required, when inflows exceed process water demand and storage capacity; the discharge may be directed to Bagsverd Creek or Mesomikenda Lake

Precipitation on infrastructure footprints as well as runoff from their respective watersheds was directed to the water management facilities. Each water retaining feature (i.e., the mine water pond, seepage collection ponds, polishing pond, TMF reclaim pond) was assigned an upper storage limit, beyond which water was discharged to a subsequent reservoir, or in the case of the polishing pond, to the environment.

It is recognized that pumping will play a large role in water management during operations; however optimal pumping rates have not yet been determined for the majority of the water management features. For the hydrological model, pumping was estimated (at a constant rate) at the MRA and ore stockpile collection ponds as well as from the process plant to the TMF. Other features assumed that the volume of water above the active storage could be transferred to the subsequent reservoir on the same day in which it occurred

The modelling effort did not include simulations of severe meteorological events or unplanned operational conditions; as such contingency water storage volumes or emergency spillways were not considered.

Processing rates, process water requirements, target flow rates and flow pathways were described by Golder (2013b) and BBA (2012). Throughout the development of the project, several iterations of water management strategies have been considered to further optimize process flows to minimize freshwater requirements and treated effluent discharge quantity. It is recognized that the duration and rate of treated effluent discharge may be further refined as the development of the Project continues. Process water and minimum freshwater demand (for uses other than potable and fire purposes) are summarized in Table 2.



Table 2: Estimated Processing Rates

Description	Estimated Rate
Process Plant Rate ¹	55,000 t/day
Process Plant water demand	55,000 m ³ /day
Tailings Production ²	55,000 t/day
Tailings Free Water ³	35,000 m ³ /day
Process Freshwater ⁴	840 m ³ /day
Reclaim Water ⁵	24,160 m ³ /day

Notes:

¹ Process plant design rate is up to 60,000 t/d, 55,000 t/d carried as a typical rate

² Tailings production tied to processing rate

³ The volume of water discharged with tailings slurry not retained in pore space

⁴ The minimum daily volume required for processing; additional freshwater may be required for potable/fire or as make-up water in the process water demand.

⁵ The volume of water that must be reclaimed from other sources apart from the tailings free water and the process freshwater to satisfy the process plant water demand.

t/d - tonne per day

m³/day – cubic metre per day

Seepage from these reservoirs is intended to be captured in collection ponds located along the perimeter of each reservoir feature. Average annual seepage rates from the Collection Ponds and waste water management features were estimated as part of ongoing engineering studies (Golder 2013d).

3.3 Model Phases

A separate GoldSim model was constructed to simulate surface water flow through the Project for each of four defined project development phases. Each of these phases is briefly summarized in the following Sections.

3.3.1 Existing Conditions

The existing conditions model was developed for the Project as investigated during the time period of the hydrological baseline study (approximately 2012 to 2013). The Project was divided into two sub-watersheds; the Mollie River watershed (defined as the watershed upstream of the Mollie River at Highway 144) and the Mesomikenda Lake watershed (to the outlet of the Lake). Lakes upstream of Chester Lake (in the Mollie River Watershed) and the Somme River outflow (in the Mesomikenda Lake watershed) were not explicitly modelled as lake features but were assimilated into the upstream watershed land cover. Existing Condition watersheds and surface water flow schematic are presented in Figure 3 and Figure 4 respectively.



3.3.2 Operational Phase

The Operational Conditions model was developed to reflect the ultimate build-out of the Project. As such, the model incorporates the realignment dams and channels as well as the estimated full extent of the open pit, TMF, MRA, ore stockpile and associated water management features.

The planned realignment dams and channels required to direct water away from the open pit incorporate the southern arm of Bagsverd Lake and small headwater features (e.g., Little Clam Lake). The development of the realignment channel around the TMF connects Bagsverd Creek to Un-named Lake #2, which was previously a headwater lake.

For this simulation, process water and site runoff collected at the Project were directed as per Table 1 and Table 2. Discharge from the polishing pond was optionally directed to Bagsverd Creek or Mesomikenda Lake. Operational Phase watersheds and surface water flow schematic are presented in Figure 5 and Figure 6, respectively.

3.3.3 Post-Closure Phase Stage I

The Post-Closure Phase Stage I model was developed to simulate surface water flow for the Project when mining has ceased. For this simulation, Project infrastructure (including realignment features) remained in place, however surface water collected at the MRA, Ore Stockpile and site runoff were directed to the open pit to facilitate flooding to its original (Côté Lake) elevation.

At the TMF, surface water was simulated to discharge passively to the east (to Mesomikenda Lake), while discharge from the polishing pond was directed passively to the west (to Bagsverd Creek). Watersheds for the Post-Closure Phase Stage I were not altered from the Operational Phase, and a flow schematic for Post-Closure Stage I is presented in Figure 7.

3.3.4 Post-Closure Phase Stage II

For the Post-Closure Phase Stage II model, the Project was simulated to have surface water flow paths similar to the Existing Conditions. Through the removal or blockage of several realignment features, flow was redirected through the flooded Côté Pit Lake. On-site water management features such as the collection ponds associated with the MRA were allowed to discharge passively to adjacent surface water receivers. Post-Closure Phase Stage II watersheds and surface water flow schematic are presented in Figure 8 and Figure 9, respectively.

3.4 Assumptions and Limitations

The constructed hydrological model described above makes the following assumptions:

- Snow water equivalent (SWE) was assumed at a 1:10 ratio, where 1 mm of SWE was assumed to represent 1 cm of snowpack. Seasonal snow density changes were not incorporated into the model.



- Potential evaporation rate from the pond surfaces was assumed to be equal to the potential evapotranspiration rate estimated using the Thornthwaite method.
- Pond and catchment sublimation from snow surfaces when air temperature was <0 °C was estimated at 0.3 mm/day, consistent with research in similar settings north of Sudbury (Pejam et al 2006).
- Process flow data were based on available information in January 2014 and are subject to change as site water management changes.

As a result of the daily climate input and daily model output, the hydrological model is not considered appropriate for discrete storm event scenarios (such as the Timmins Design Storm) that occur on a less than 24-hour basis. As such, the model is not intended to produce instantaneous peak water level and peak discharge for design purposes that require storm event-scale calculations.

4.0 MODEL VERIFICATION

The verification of the GoldSim model was completed with the Existing Conditions version and data collected from regional hydrological stations at the Mollie River (Water Survey of Canada [WSC]) and the Mesomikenda Lake Dam (Ontario Power Generation; Golder 2013a)

For the unregulated Mollie River, the cumulative flow for the period 2008 - 2009 was compared for the model output and the recorded discharge from the WSC gauge (Figure 10). For this period, the GoldSim model underestimated total flow by 8%, which was considered acceptable in the context of the level of detail available for site waterways (Golder 2013a).

For the regulated Mesomikenda Lake, the predicted water elevation in the lake was maintained within the normal operational range and mimicked the seasonal variability that results from the insertion and removal of stoplogs at the dam (Figure 11).

The model verification exercise was an assessment that the Existing Conditions model approximated the water level and discharge of the surface water system of the Project. Other project phases were subsequently compared to the Existing Conditions in order to give a relative change in surface water level and streamflow. Future modelling efforts may improve verification through the collection of additional field information.

5.0 RESULTS

The following sections outline the results of the climate statistical analysis and the hydrological modelling.

5.1 Climate

The estimated statistical climate data are displayed on Table 3, along with the representative year and rainfall depth corresponding to that year. The selected climate years are subject to the intra-annual variability that was estimated for the Project during that year, and as such the selected years do not follow similar monthly



precipitation distributions. Monthly distributions of precipitation for the wet, dry and average years are displayed on Figure 12. Although the model was capable of simulating the entire assembled climate dataset (43 years), these three representative years were selected for analysis and presentation. The simulated climate output for the selected 1:25-year wet, 1:25-year dry and average conditions are provided in Appendix B.

Table 3: Climate Summary

Description	1:25-year Wet Condition	Average Condition	1:25-year Dry Condition
Log Pearson III Analysis Total Annual Precipitation	989 mm	856 mm	734 mm
Year in Climate Record Best Matching Statistical Analysis	1990	1971	2005
Total Precipitation Depth in Year (used in simulation)	1003 mm	854 mm	734 mm

Note:
mm - millimetre

5.2 Hydrological Output

Simulated hydrological output was compiled as average daily discharge and water level for the lakes and streams in the vicinity of the Project. This output was summarized for each of the selected climate conditions and the four simulated project phases and is provided in Appendix C. The results of this simulation were subsequently used to estimate potential change in the hydrological system at the Project. In addition, the results were provided to other disciplines, including the aquatic biology and water quality teams as input data for results that are presented in the Water Quality Technical Support Document (TSD; Golder 2013e) and Aquatic Biology TSD (Minnow 2013).

6.0 CONCLUSIONS

A hydrological model was developed in GoldSim to estimate the rainfall/runoff response in watersheds at the Côté Gold Project. The model was based on hydrometric and meteorological information collected during baseline studies at the Project. The model was developed with existing conditions and reviewed against regional hydrological monitoring stations.

A statistical analysis of precipitation at the Project allowed for a variety of climate conditions to be simulated, from which a representative 1:25-year dry, 1:25-year wet and average year were selected.

Subsequently three additional GoldSim models were adapted to incorporate the planned extent of infrastructure on, and water management objectives at, the Project. These models provided were coupled with the climate variation to provide an estimate of the variability in streamflow and water level resulting from the development and rehabilitation of the Project.



The results of the hydrological modelling were used to determine an estimate of potential change in the hydrological system at the Project, and the data were also provided to other disciplines for use in their respective studies.

7.0 REFERENCES

- BBA. 2012. Prefeasibility Study Water Balance Diagram (for discussion) drawing reference 601-D-0102-0A.
- Calder Engineering. 2012. Conceptual Plan, Mollie River Re-alignment, Figure reference 12-125-W0.
- Cumming Cockburn Limited. 1995. Regionalization of Low Flows, Map F.
- Golder Associates Ltd. (Golder). 2013a. Hydrology and Climate Baseline Report, Côté Gold Project. Report Number 12-1192-0010R (8000/8030).
- Golder. 2013b. Water Balances – Mine Rock Area, Tailings Management Facility and Mine Water Pond, Côté Gold Project. Document No. 002- Version 4.
- Golder. 2013c. Groundwater Model, Côté Gold Project. Report Number 13-1192-0021 (3000/3020).
- Golder. 2013d. Côté Gold Project – Mine Rock Storage Pond Seepage Analysis. DOC008.
- Golder. 2013e. Draft Water Quality Technical Support Document, Côté Gold Project. Report
- GoldSim. 2013. GoldSim User's Guide Volume 1.
- Minnow. 2013. Côté Gold Aquatic Technical Support Document, Prepared for IAMGOLD Corporation, Gogama ON.
- Pejam M.R., M.A. Arain and J.H. McCaughey. 2006. Energy and water vapour exchanges over a mixed wood boreal forest in Ontario, Canada. Hydrological Processes vol. 20, pp.3709-3724.
- Pyrce, R. 2004. Hydrological Low Flow Indices and their Uses. WSC Report 04-2004.
- Pysklywec, D.W., K.S. Davar and D.I. Bray. 1968. Snowmelt at an index plot. Water Resources Research 4 pp. 937-946.
- Spectranalysis Inc. 2004. Introduction to the Ontario Land Cover Data Base, Second Edition (2000): Outline of Production Methodology and Description of 27 Land Cover Classes. Report to Ontario Ministry of Natural Resources. Unpublished"
- Thornthwaite, C. W. and J.R. Mather. 1957. Instructions and tables for computing potential evapotranspiration and the water balance. Publications in Climatology X 311 pp.



Report Signature Page

GOLDER ASSOCIATES LTD.

Stephen Kaufman, M.Sc.
Hydrologist



John Petrie, P.Ge.
Principal

SK/JMP/lis

Golder, Golder Associates and the GA globe design are trademarks of Golder Associates Corporation.

m:\active\2013\1190 sudbury\1192\13-1192-0021 iamgold cote gold project timmins\2. hydrology and climate\reporting\tsd\appendices revised\13-1192-0021r 14oct30 revised attach ii _hydrology model.docx

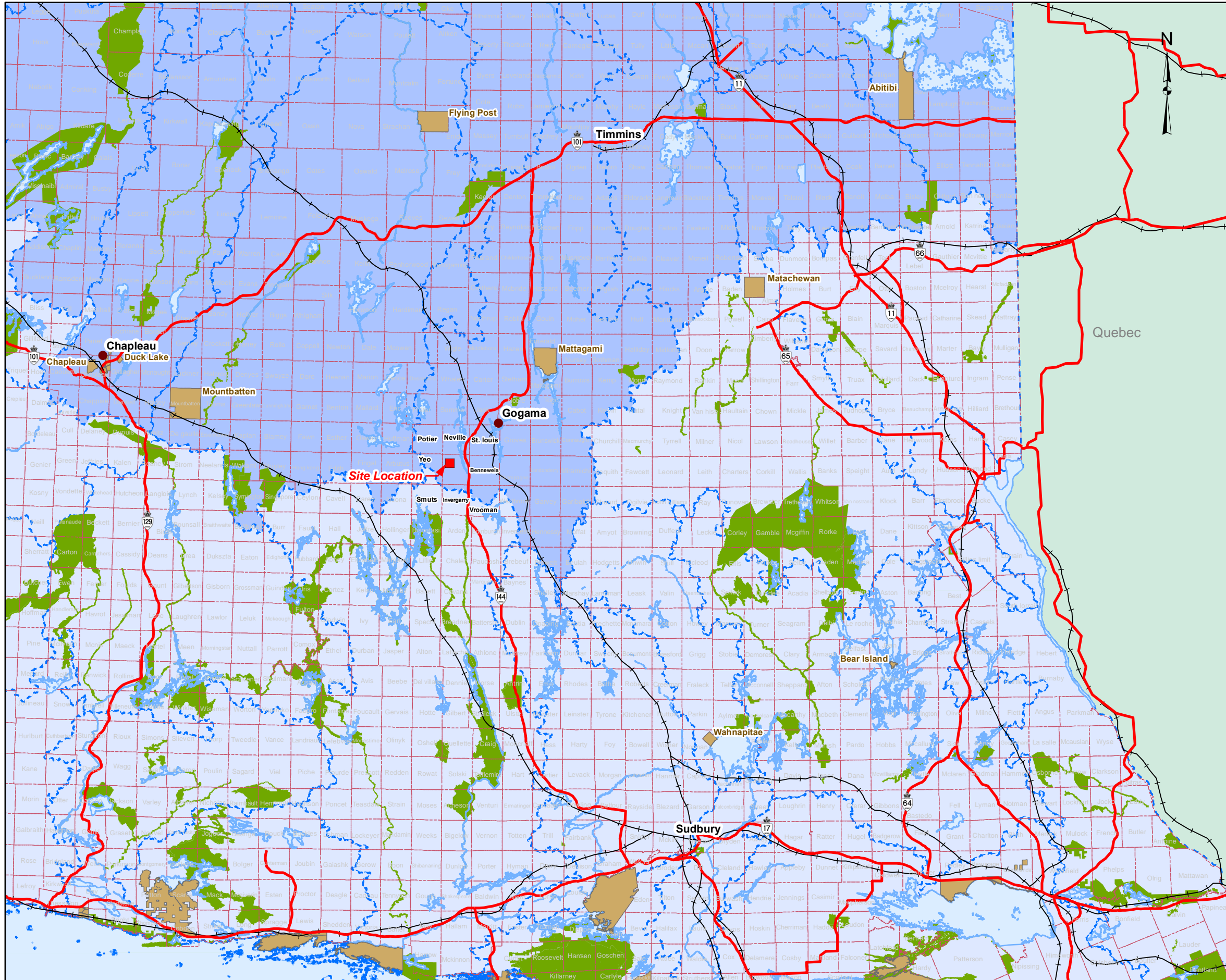
Path: Z:\Projects\2013\13-1192-0021\GIS\MXDs\Reporting\Hydrology\Modelling_Report\Figure1_Project_Location.mxd



LEGEND

- Populated Places
- Major Roads
- Railway
- First Nations Communities
- Townships
- Provincial Park
- Primary Watersheds**
- Hudson Bay
- Great Lakes

REFERENCE

Base Data - MNR NRVIS, CANMAP v2008.4
 Produced by Golder Associates Ltd under licence from
 Ontario Ministry of Natural Resources, © Queens Printer 2014
 Projection: Transverse Mercator Datum: NAD 83 Coordinate System: UTM Zone 17

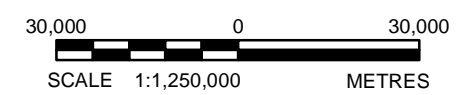

PROJECT		HYDROLOGICAL MODELLING REPORT CÔTÉ GOLD PROJECT	
TITLE		Project Location	
PROJECT No. 13-1192-0021		SCALE AS SHOWN	REV. 0
DESIGN	RRD	Dec. 2012	<p>FIGURE: 1</p>
GIS	RRD	Dec. 2013	
CHECK	SK	Jan. 2014	
REVIEW	JMP	Jan. 2014	



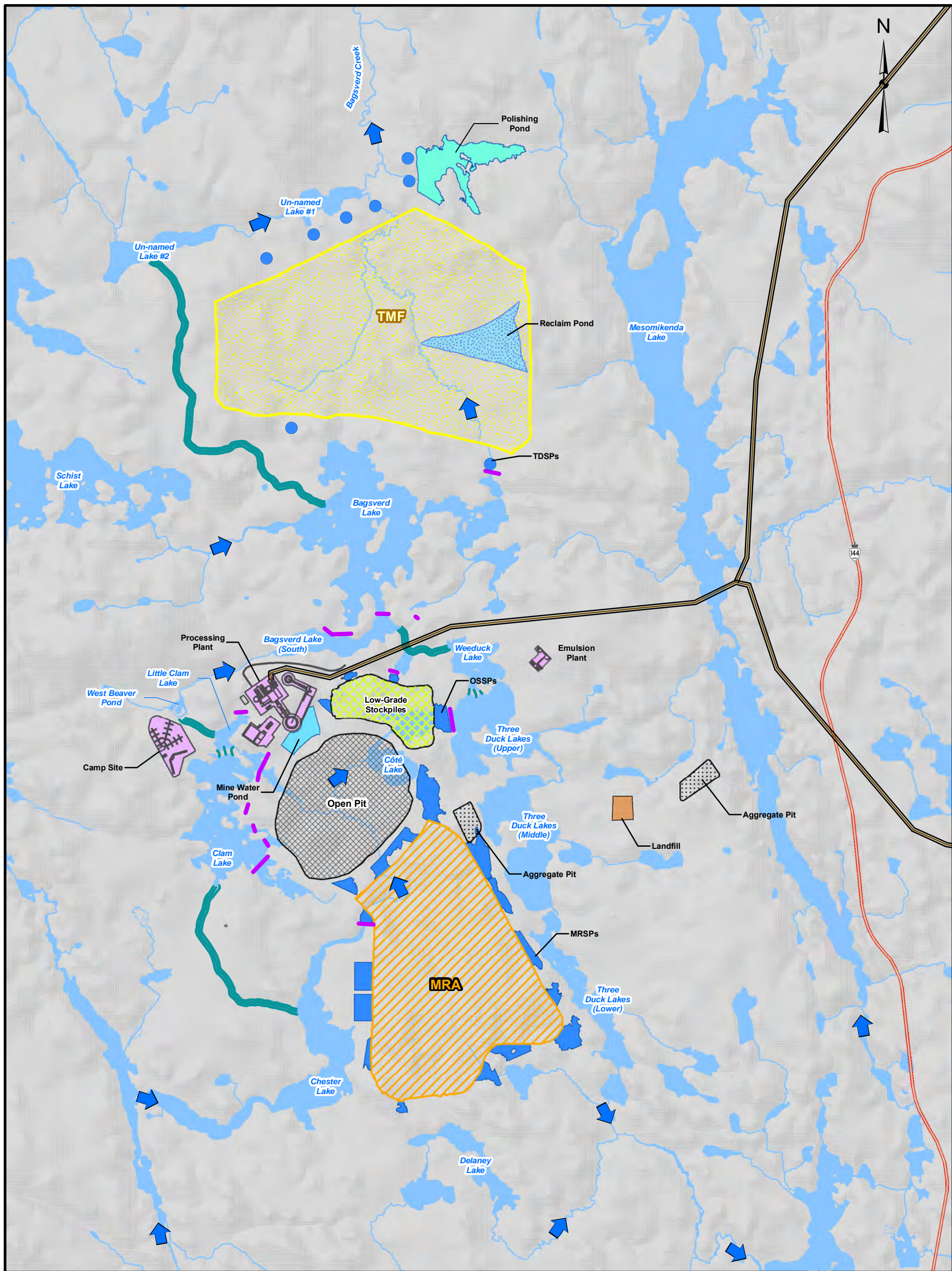

LEGEND

- Highway 144
- Realignment Dams
- Transmission Line
- Watercourse Realignment
- Low-Grade Stockpiles
- Mine Rock Area (MRA)
- Tailings Management Facility (TMF)
- Open Pit
- Polishing Pond
- Reclaim Pond
- Aggregate Pit
- Facilities
- Mine Water Pond
- Landfill
- Collection Ponds
- Waterbodies
- Creek / River
- Surface Water Flow Direction

NOTE:

Project site components are based on the ultimate extents of these facilities. (End of operations phase)

REFERENCE

Open Pit Shell provided by IAMGOLD, May 2013
 Base Data - MNR NRVIS, CANMAP v2008.4
 Produced by Golder Associates Ltd under licence from Ontario Ministry of Natural Resources,
 © Queens Printer 2013
 Projection: Transverse Mercator Datum: NAD 83 Coordinate System: UTM Zone 17

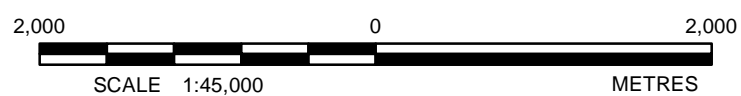

PROJECT		HYDROLOGICAL MODELLING REPORT	
IAMGOLD		CÔTÉ GOLD PROJECT	
TITLE		Site Plan	
PROJECT No. 13-1192-0021		SCALE AS SHOWN	REV. 0
DESIGN	RRD	Feb. 2013	FIGURE: 2
GIS	AL	Oct. 2013	
CHECK	SK	Jan. 2014	
REVIEW	JMP	Jan. 2014	



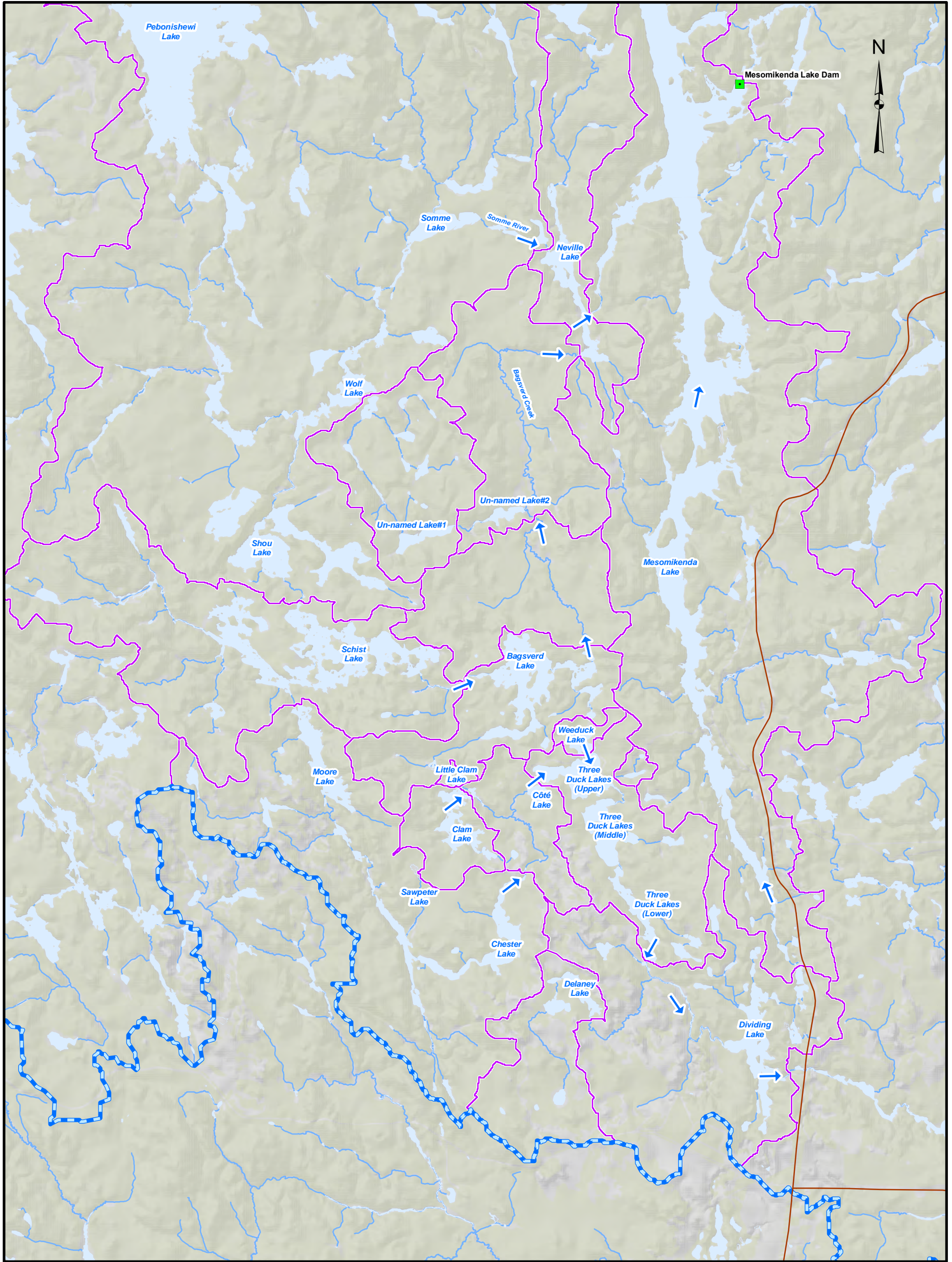

LEGEND

- Dams (OPG)
- Creek / River
- James Bay / Great Lakes Watershed Divide
- Wooded Areas
- Existing Watersheds
- Waterbodies
- ← Waterflow

REFERENCE

Base Data - MNR NRVIS, CANMAP v2008.4
 Produced by Golder Associates Ltd under licence from Ontario Ministry of Natural Resources,
 © Queens Printer 2013
 Projection: Transverse Mercator Datum: NAD 83 Coordinate System: UTM Zone 17

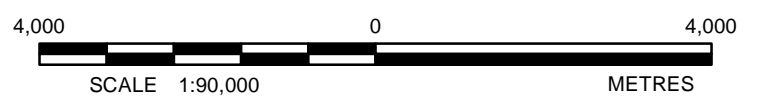

PROJECT		HYDROLOGICAL MODELLING REPORT CÔTÉ GOLD PROJECT	
TITLE		Existing Conditions Watersheds	
 Sudbury, Ontario		PROJECT No. 13-1192-0021	SCALE AS SHOWN
DESIGN	RRD	Feb. 2013	FIGURE: 3
GIS	RRD	Dec. 2013	
CHECK	SK	Jan. 2014	
REVIEW	JMP	Jan. 2014	
		REV. 0	

INFLOW FROM SCHOU, PEBONISHEWI, BILLIE, OWATAWETNES, MOUSE, WOLF, VIVIAN, WHALSOM AND SOMME LAKES

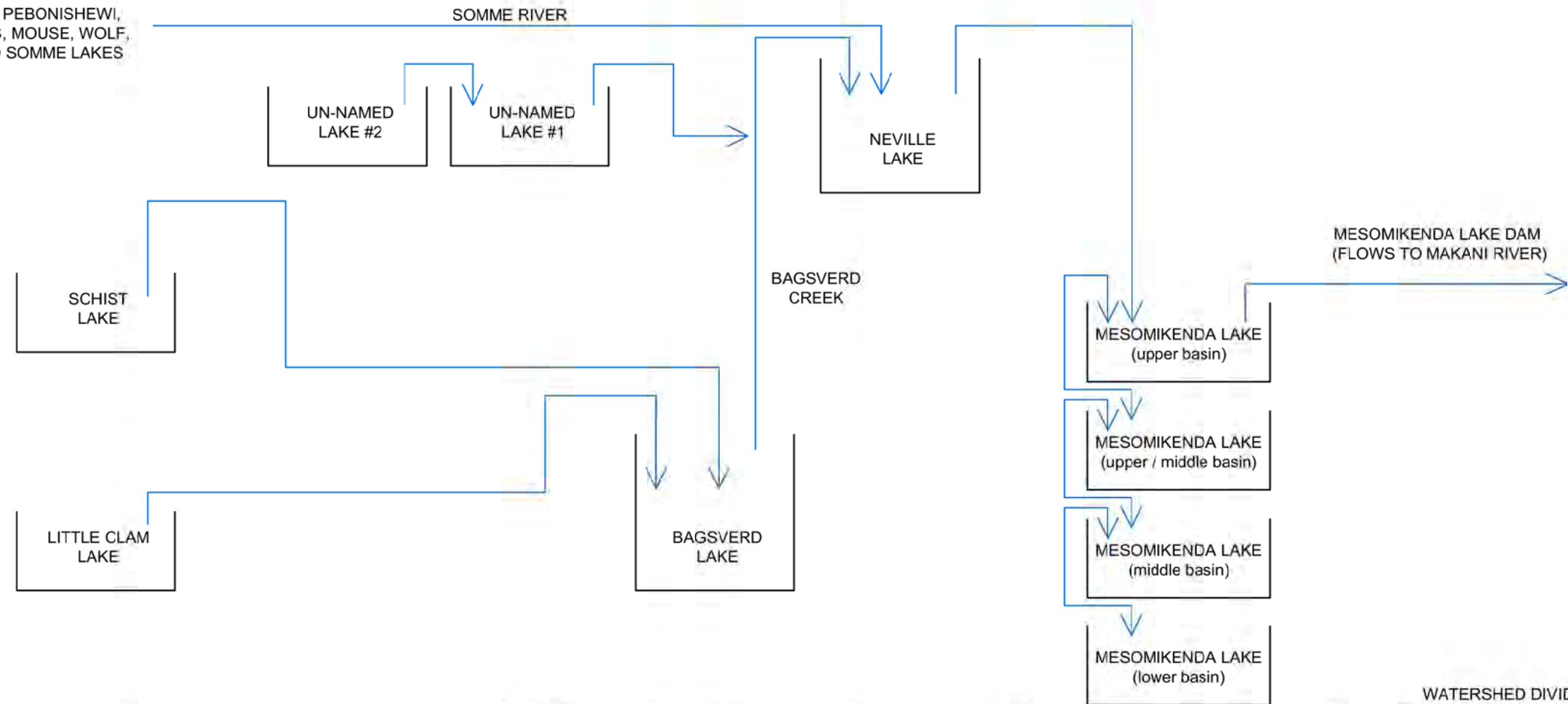

WATERSHED DIVIDE

INFLOW FROM ASH, MOORE, CHAIN, ATTACH AND SAWPETER LAKES

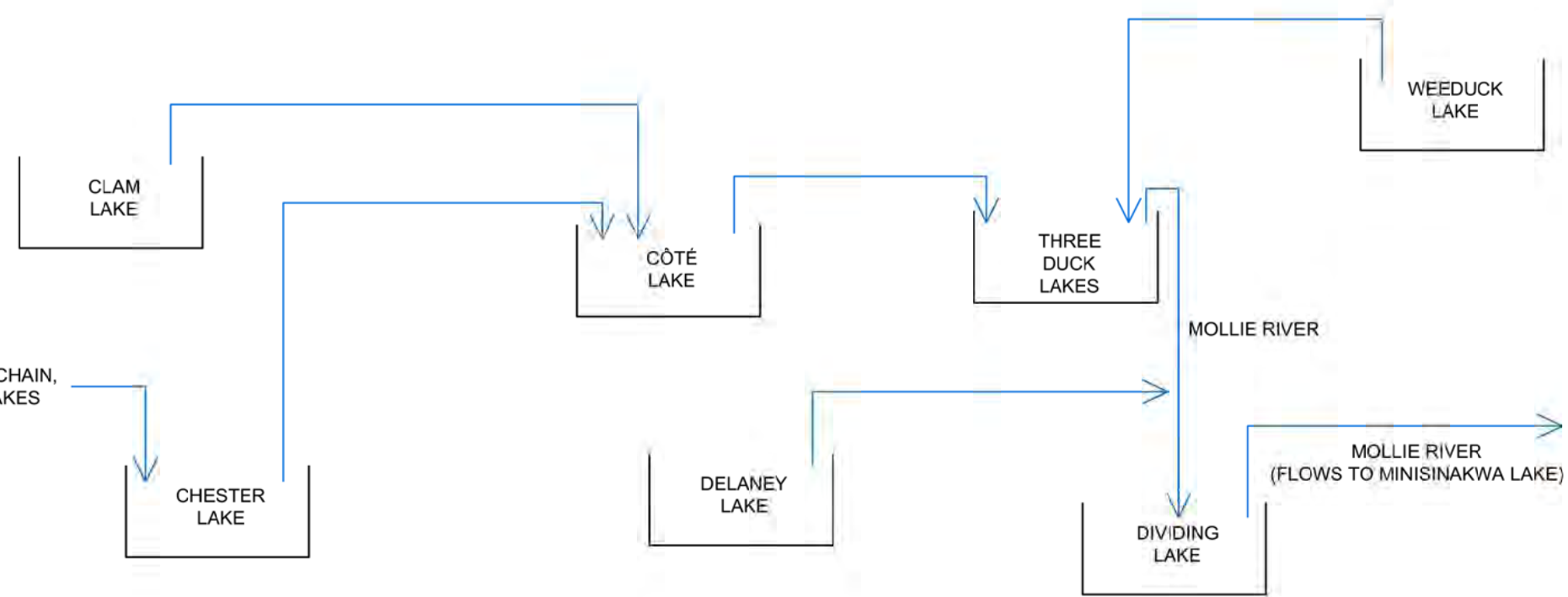

LEGEND
FLOW DIRECTION
— EXISTING / NATURAL

REV	DATE	WATERSHEDS FOR DISCUSSION	SK	JUL	XXX	XXX
		#REVISION DESCRIPTION	DES	CADD	CHK	RVW
PROJECT: HYDROLOGICAL MODELLING REPORT						
TITLE: CÔTÉ GOLD PROJECT						
EXISTING CONDITIONS FLOW SCHEMATIC						
PROJECT No.13-1192-0021.1000 *****			FILE No.		1311920021A005	
DESIGN	SK	2014-01-31	SCALE		NOT TO SCALE	
CADD	JUL	2014-01-31	FIGURE		4	
CHECK	SK	2014-01-31				
REVIEW	JMP	2014-01-31				

I:\golder\golder\Subsidiary\CAD-GIS\CAD\Projects\2013\13-1192-0021 IAMGold Cote Gold\Civil_3D\1311920021A005.dwg | Layout: Figure 1 | Modified: iberecz 01/28/2014 2:20 PM | Plotted: iberecz 01/28/2014

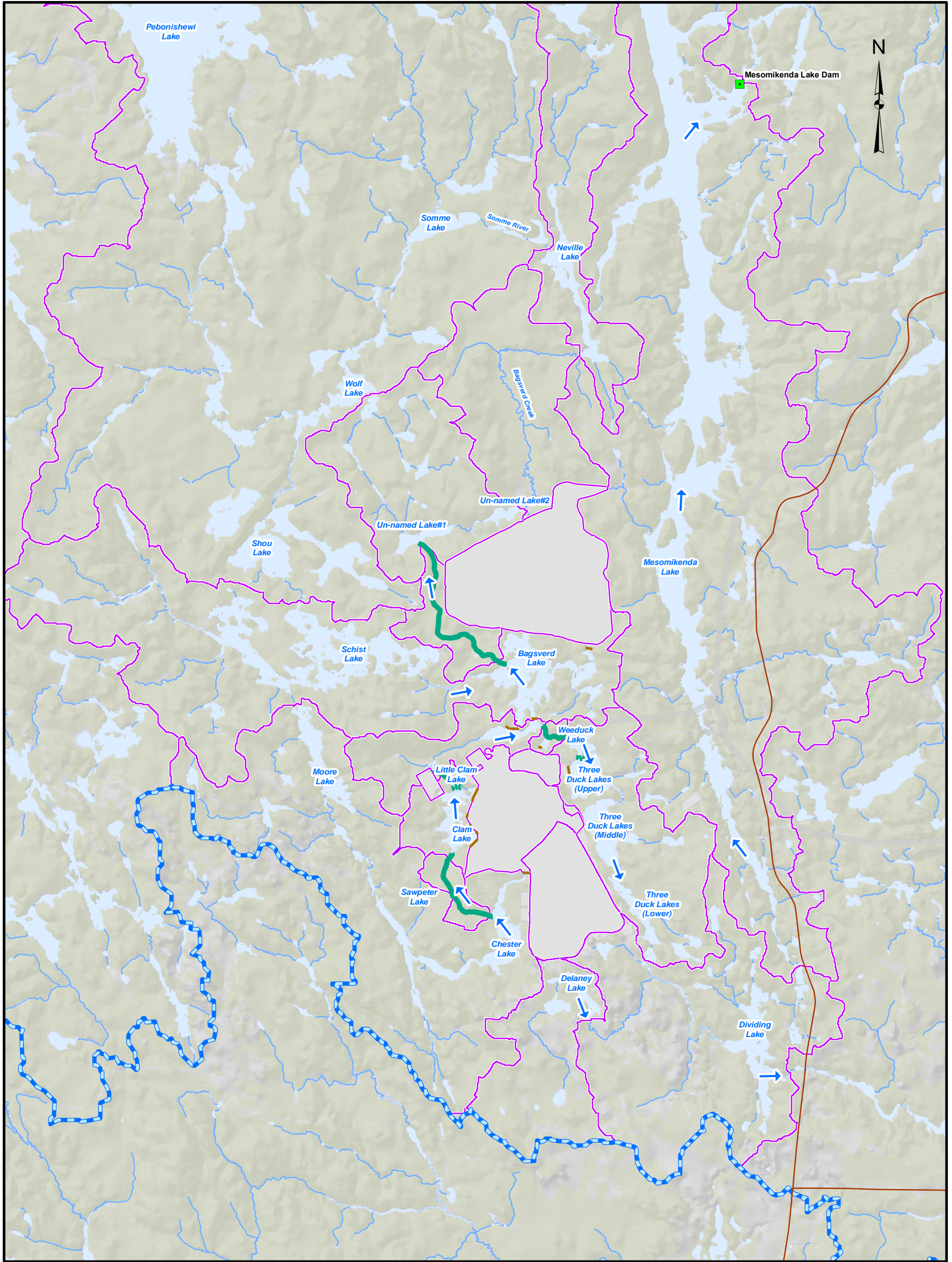

LEGEND

- Dams (OPG)
- Watercourse Realignment
- Dam
- Major Roads
- James Bay / Great Lakes Watershed Divide
- Infrastructure Watersheds
- Infrastructure
- ← Waterflow
- Creek / River
- Waterbodies
- Wooded Areas

REFERENCE

Base Data - MNR NRVIS, CANMAP v2008.4
 Produced by Golder Associates Ltd under licence from Ontario Ministry of Natural Resources,
 © Queens Printer 2013
 Projection: Transverse Mercator Datum: NAD 83 Coordinate System: UTM Zone 17

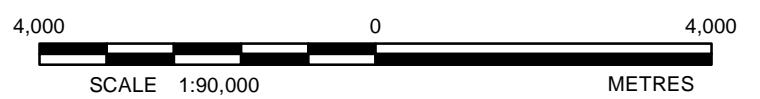

PROJECT		HYDROLOGICAL MODELLING REPORT CÔTÉ GOLD PROJECT	
TITLE			
Operations Phase Post-Closure Phase Stage I Watersheds			
PROJECT No. 13-1192-0021		SCALE AS SHOWN	REV. 0
DESIGN	RRD	Feb. 2013	FIGURE: 5
GIS	RRD	Dec. 2013	
CHECK	SK	Jan. 2014	
REVIEW	JMP	Jan. 2014	



INFLOW FROM SCHOU, PEBONISHEWI, BILLIE, OWATAWETNES, MOUSE, WOLF, VIVIAN, WHALSOM AND SOMME LAKES

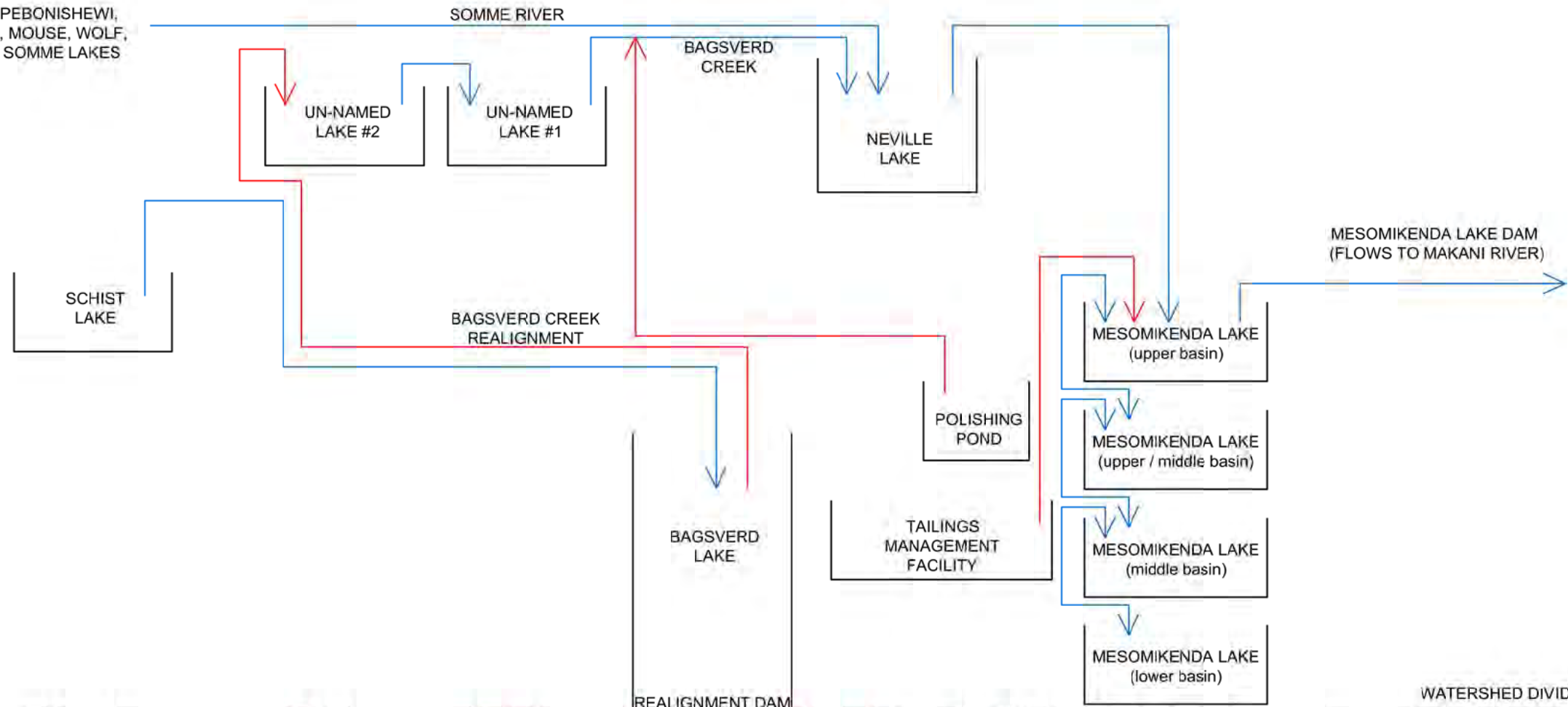

MESOMIKENDA LAKE DAM (FLOWS TO MAKANI RIVER)

WATERSHED DIVIDE

INFLOW FROM ASH, MOORE, CHAIN, ATTACH AND SAWPETER LAKES

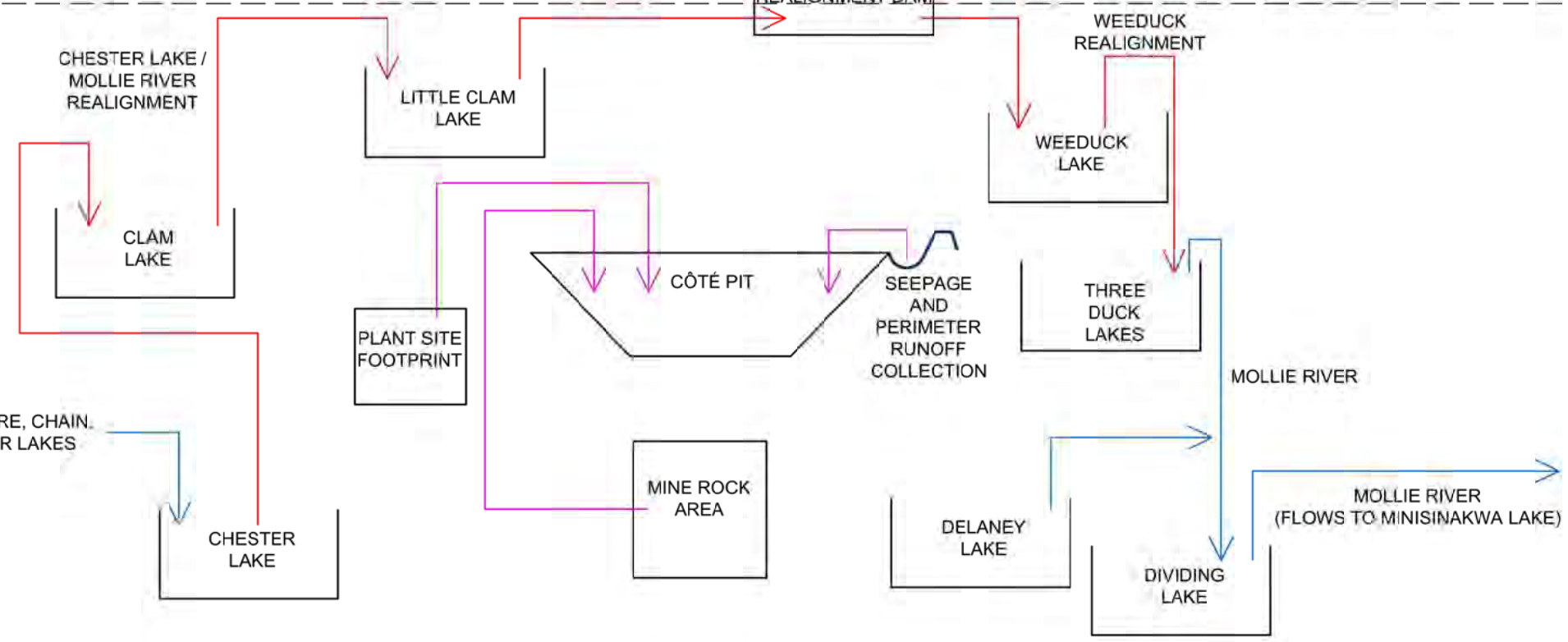

LEGEND
 FLOW DIRECTION
 ——— EXISTING / NATURAL
 ——— REALIGNMENT
 ——— SITE WATER

2013-11-15	WATERSHEDS FOR DISCUSSION	SK	JUL	XXX	XXX
REV	DATE	DES	CADD	CHK	RVW
PROJECT		HYDROLOGICAL MODELLING REPORT			
IAMGOLD		CÔTÉ GOLD PROJECT			
TITLE					
POST - CLOSURE PHASE STAGE I FLOW SCHEMATIC					
PROJECT No.13-1192-0021.1000.****		FILE No.		1311920021A005	
DESIGN	SK	2014-01-31	SCALE	NOT TO SCALE	
CADD	JUL	2014-01-31	FIGURE	7	
CHECK	SK	2014-01-31			
REVIEW	JMP	2014-01-31			

I:\gold\gms\Subs\Sub-CAD-CAD\Projects\2013\13-1192-0021 IAMGold Cote Gold\CIVIL_3D\1311920021A005.dwg | Layout: Figure 3 | Modified: berez 01/28/2014 2:20 PM | Plotted: berez 01/28/2014

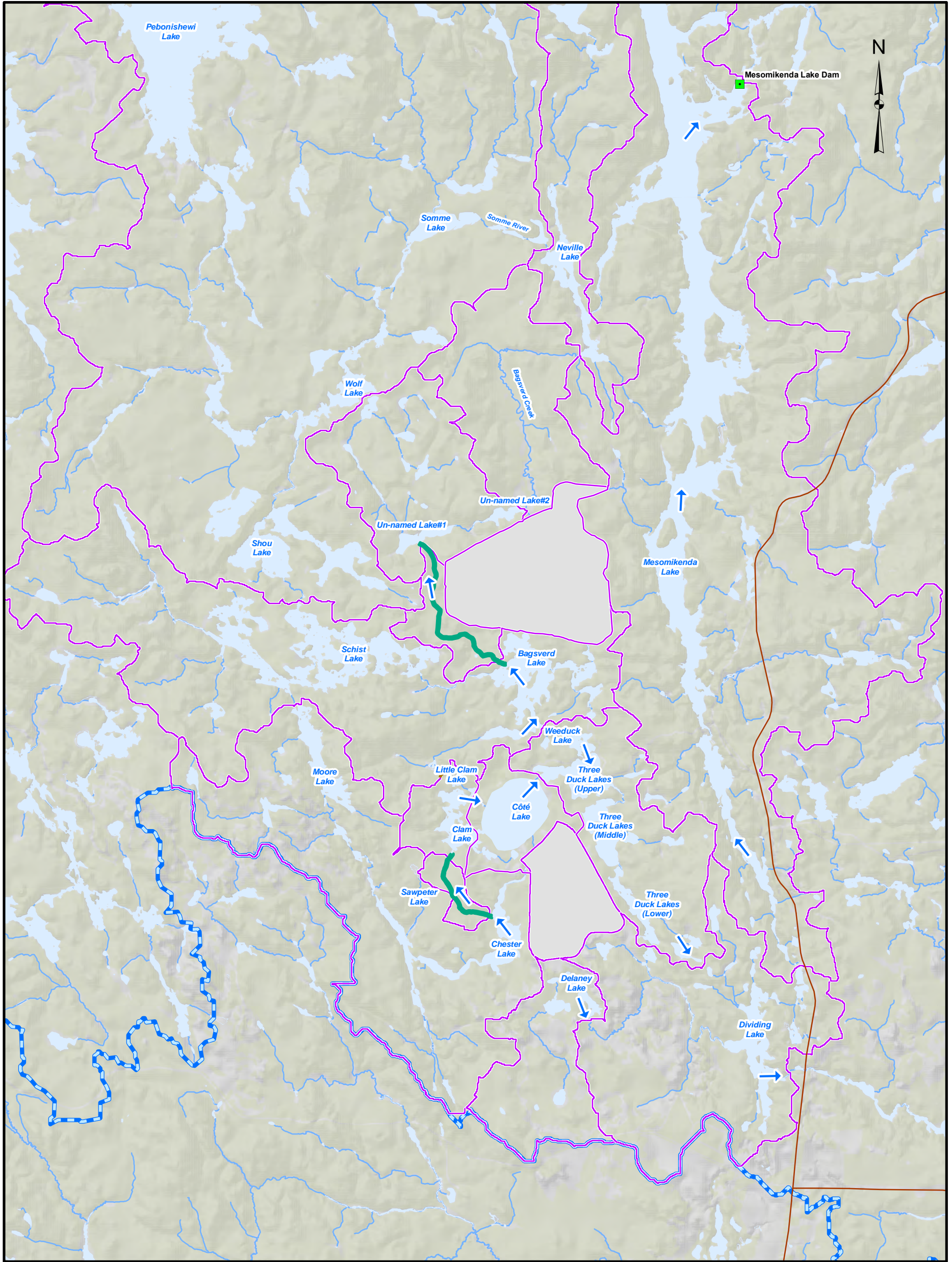

LEGEND

- Dams (OPG)
- Closure_Dams
- Watercourse Realignment
- Major Roads
- Watersheds
- ← Waterflow
- James Bay / Great Lakes Watershed Divide
- Infrastructure
- Waterbodies
- Creek / River
- Wooded Areas

REFERENCE

Base Data - MNR NRVIS, CANMAP v2008.4
 Produced by Golder Associates Ltd under licence from Ontario Ministry of Natural Resources,
 © Queens Printer 2013
 Projection: Transverse Mercator Datum: NAD 83 Coordinate System: UTM Zone 17

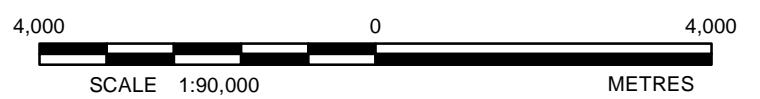

PROJECT		HYDROLOGICAL MODELLING REPORT CÔTÉ GOLD PROJECT	
TITLE			
<h2 style="margin: 0;">Post-Closure Phase Stage II Watersheds</h2>			
		PROJECT No. 13-1192-0021	SCALE AS SHOWN
DESIGN	RRD	Feb. 2013	FIGURE: 8
GIS	RRD	Dec. 2013	
CHECK	SK	Jan. 2014	
REVIEW	JMP	Jan. 2014	
Sudbury, Ontario		REV. 0	

Path: Z:\Projects\2013\13-1192-0021\GIS\MXDs\Reporting\Hydrology\Modelling_Report\Figure8_Post closure watersheds.mxd

INFLOW FROM SCHOU, PEBONISHEWI, BILLIE, OWATAWETNES, MOUSE, WOLF, VIVIAN, WHALSOM AND SOMME LAKES

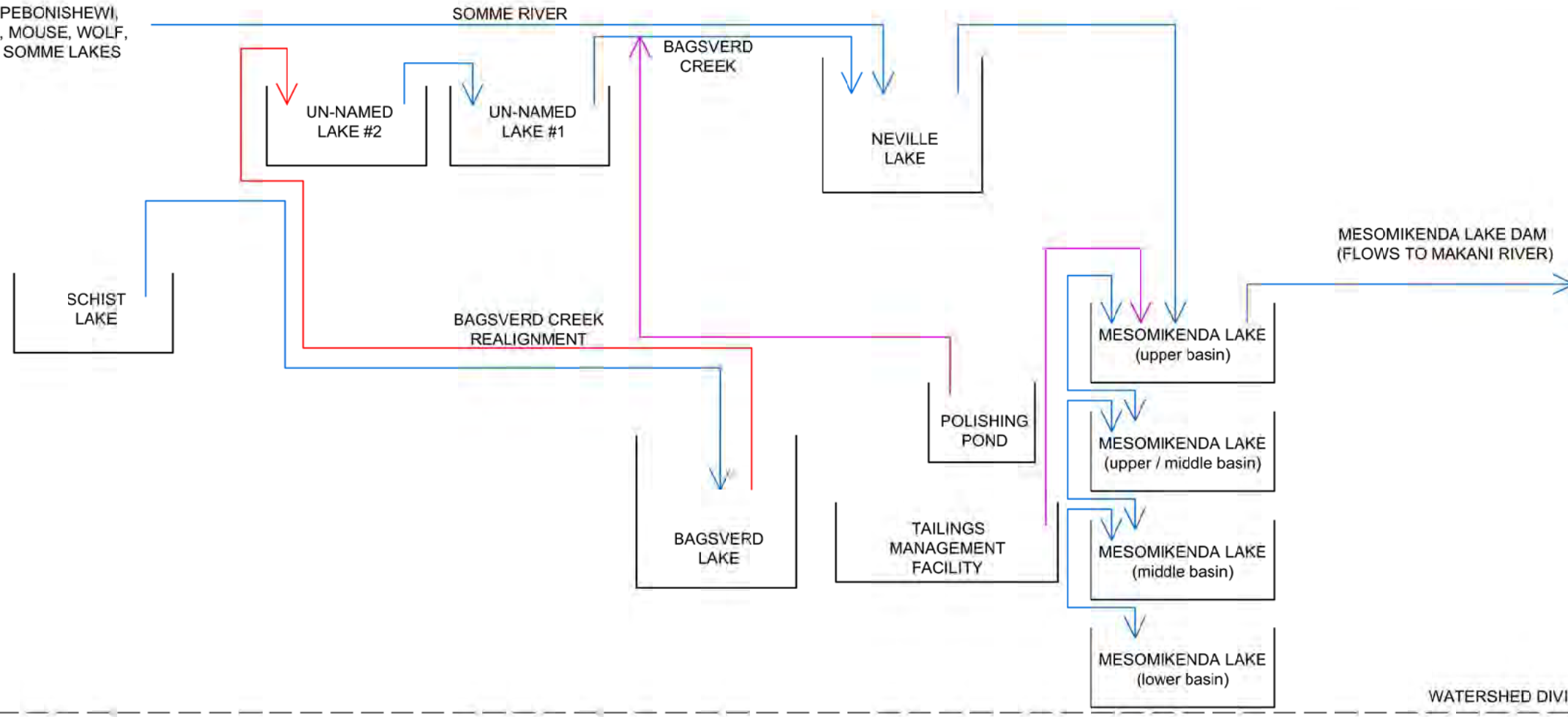

MESOMIKENDA LAKE DAM
(FLOWS TO MAKANI RIVER)

WATERSHED DIVIDE

INFLOW FROM ASH, MOORE, CHAIN, ATTACH AND SAWPETER LAKES

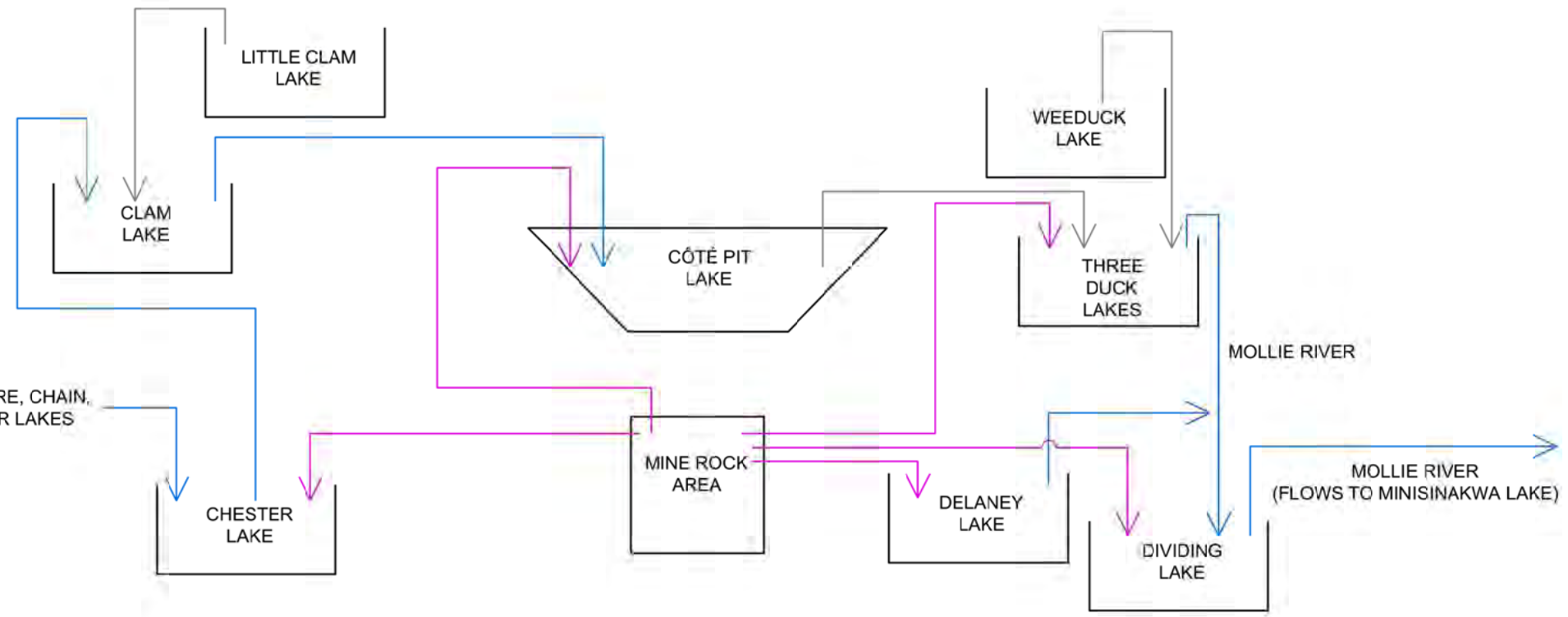

MOLLIE RIVER

MOLLIE RIVER
(FLOWS TO MINISAKWA LAKE)

- LEGEND**
- FLOW DIRECTION
 - EXISTING / NATURAL
 - REALIGNMENT
 - SITE WATER
 - RESTORED OR REDIRECTED

REV	DATE	WATERSHEDS FOR DISCUSSION	SK	JUL	XXX	XXX
		REVISION DESCRIPTION	DES	CADD	CHK	RVW
PROJECT		HYDROLOGICAL MODELLING REPORT				
PROJECT		IAMGOLD CÔTÉ GOLD PROJECT				
TITLE		POST - CLOSURE PHASE STAGE II FLOW SCHEMATIC				
PROJECT No.13-1192-0021.1000 *****		FILE No.		1311920021A005		
DESIGN	SK	2014-01-31	SCALE		NOT TO SCALE	
CADD	JUL	2014-01-31	FIGURE		9	
CHECK	SK	2014-01-31				
REVIEW	JMP	2014-01-31				

I:\gold\pds\gold\SubArea\CAD\CAD\Projects\2013\13-1192-0021 IAMGold Code Gold\CIVIL_3D\1311920021A005.dwg | Layout: Figure 4 | Modified: 2014-01-28 2:20 PM | Plotted: 2014-01-28 2:20 PM

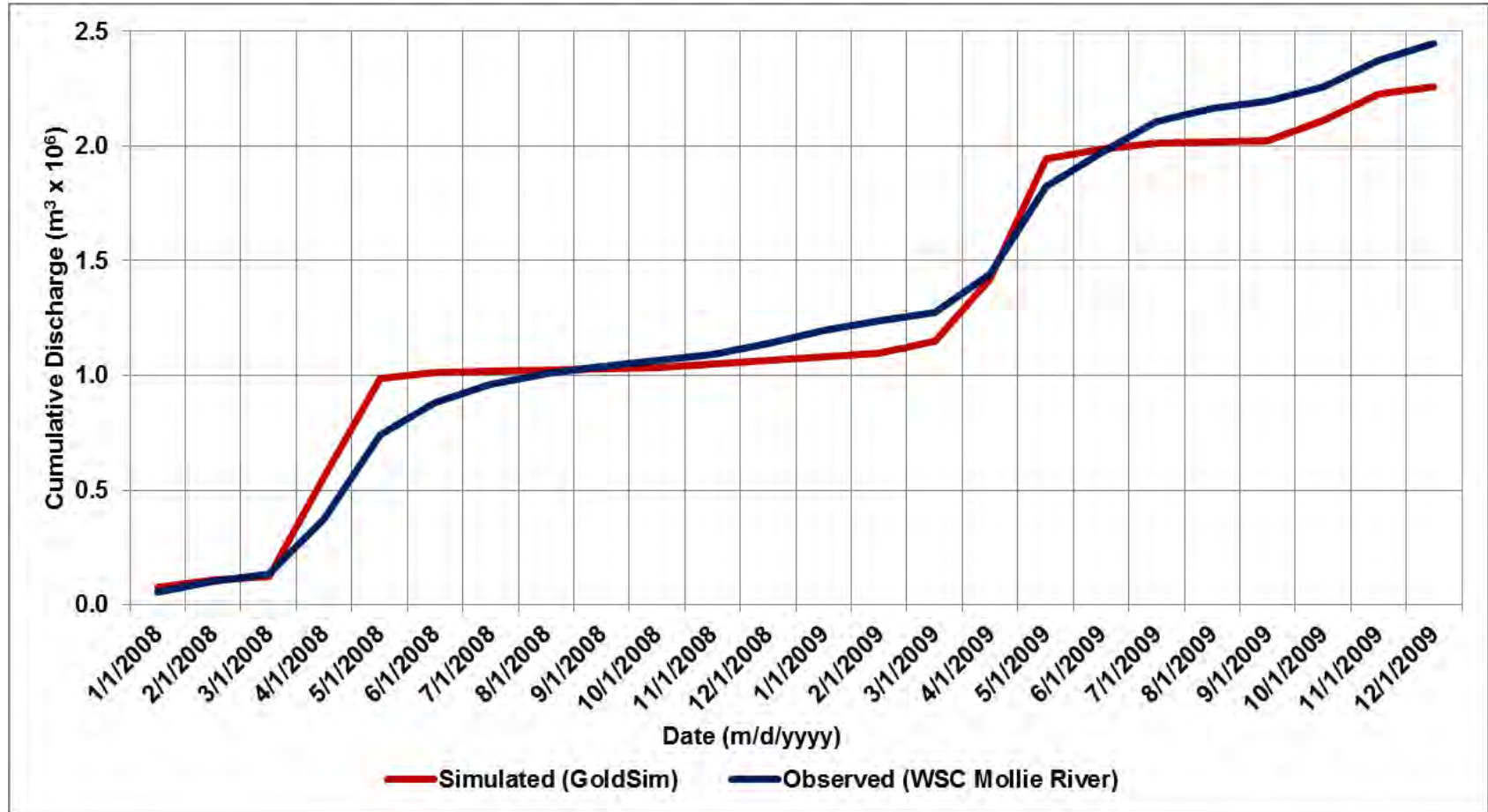

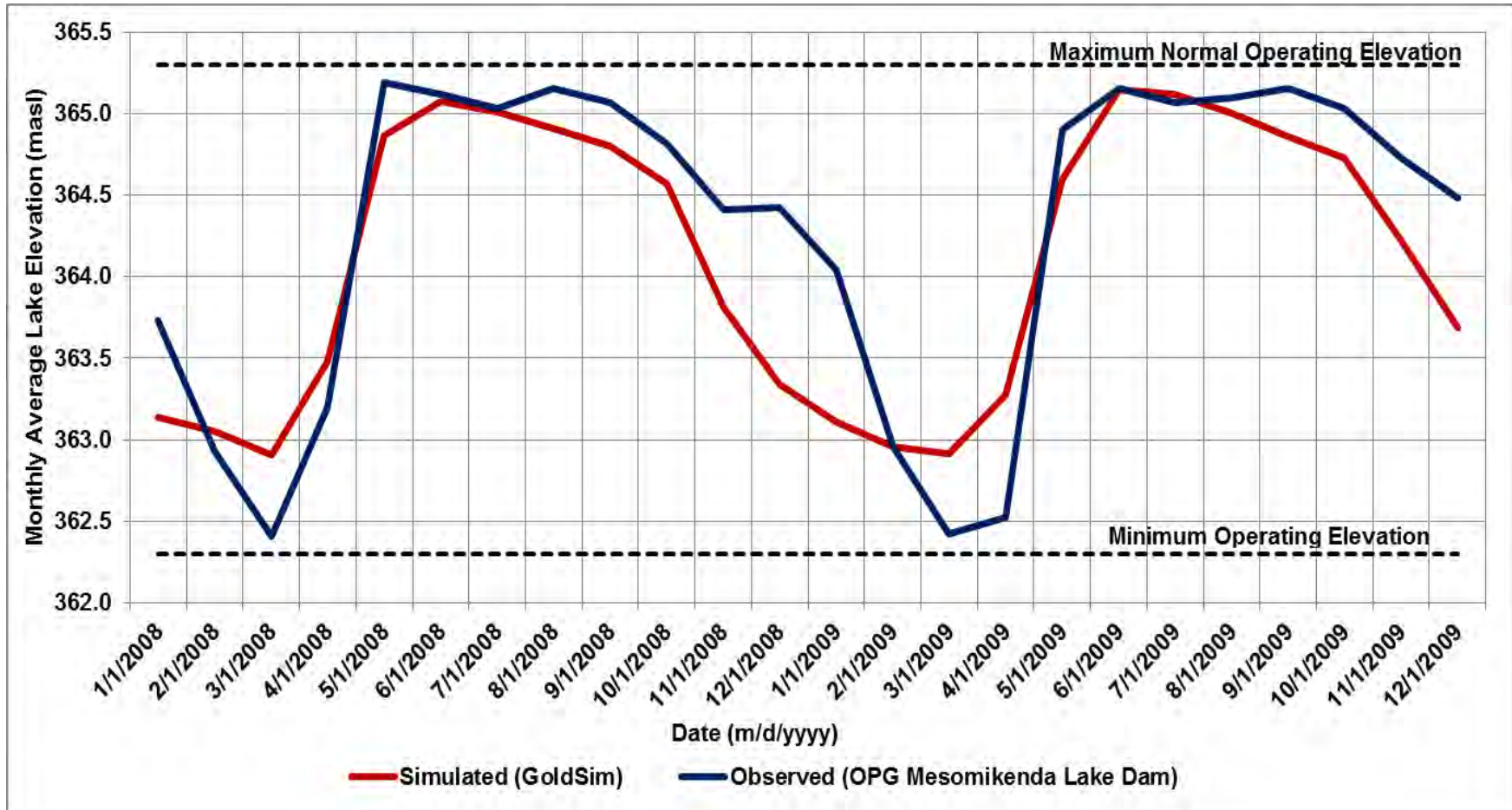

IAMGOLD Corporation
Hydrologic Modelling Report, Côté Gold Project
Simulated Monthly Total Precipitation

FIGURE 12

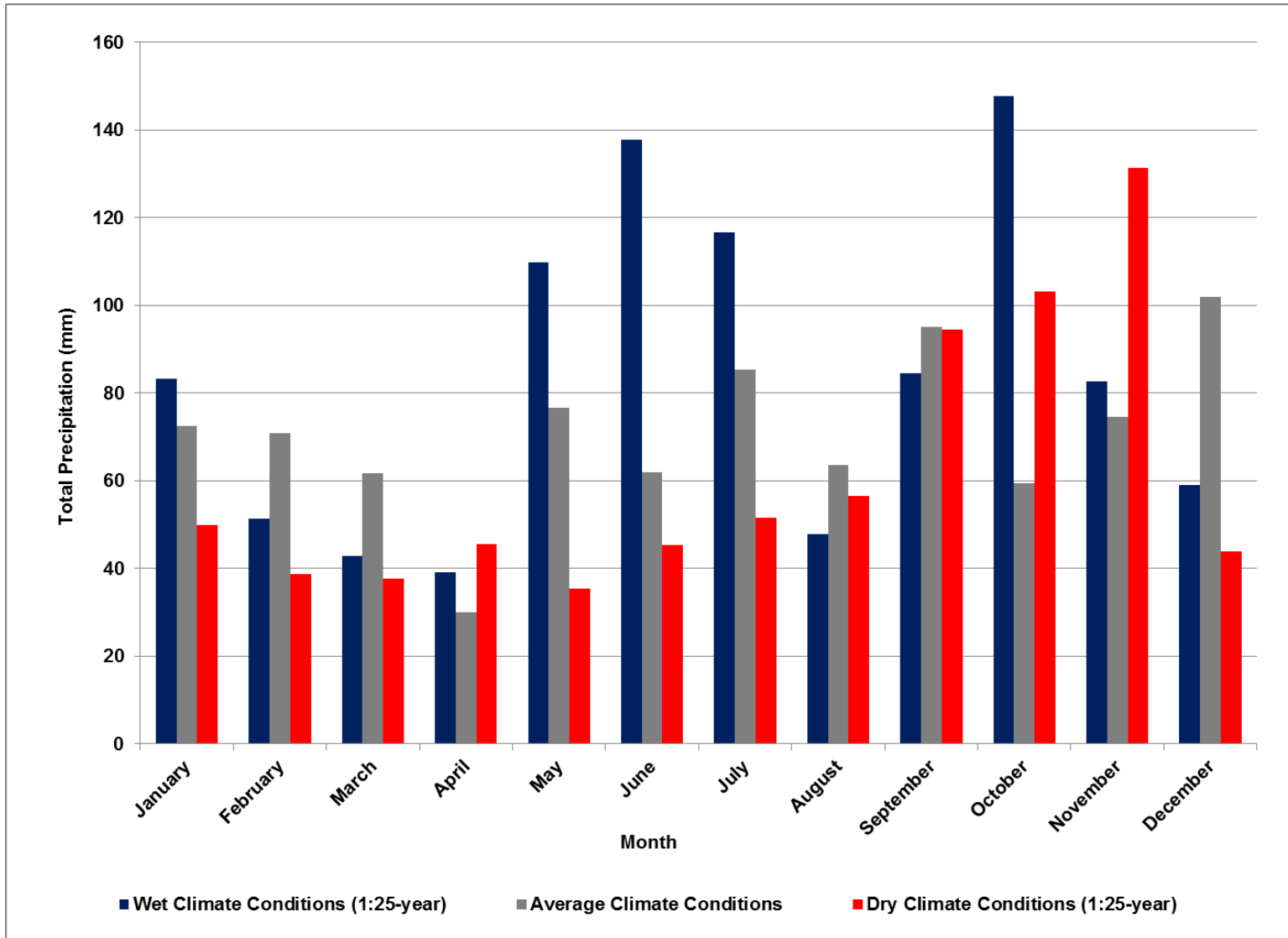



APPENDIX A

Low Flow Statistics

Site ID ¹	Site Description	Watershed Area (km ²)	7Q ₂₀ (m ³ /s)	30Q ₂ (m ³ /s)	7Q ₂₀ Unit Flow (L/s/km ²)	Notes
02JC008	Blanche River above Eagleheart (Environment Canada Station)	1782	2.27	4.53	1.3	Used as reference station for pro-rating local gauge flow statistics
02CF012	Junction Creek at Sudbury (Environment Canada Station)	199	0.36	1.17	1.8	Urban station; regulated upstream of gauge not used in statistical estimates
04LA006	Mollie River at Highway No. 144 (Environment Canada Station)	92	0.12	0.24	1.3	Period of record 2007 - 2012 flow statistics based on 02JC008
NEV	Neville Lake	304	0.39	0.77	1.3	--
SR	Somme River @ Neville Lake	199	0.25	0.51	1.3	--
BL_b	Bagsverd Creek @ Neville Lake	82	0.10	0.21	1.3	--
L2	Un-named Lake 2	12	0.02	0.03	1.3	--
BPD	Bagsverd Lake	43	0.05	0.11	1.3	--
SL	Schist Lake	31	0.04	0.08	1.3	--
LCM	Little Clam Lake	0.3	0.00	0.00	n/a	zero flow observed during field campaign (Golder 2013a)
DIV	Dividing Lake	92	0.12	0.24	1.3	--
DEL	Delaney Lake	9	0.01	0.02	1.3	--
3D_c	Three Duck Lakes	57	0.07	0.14	1.3	--
WD	Weeduck Lake	1	0.00	0.00	1.3	--
CL	Côté Lake	43	0.05	0.11	1.3	--
CM	Clam Lake	4	0.00	0.01	1.3	--
CHLK	Chester Lake	33	0.04	0.09	1.3	--

¹ Site ID for non-Environment Canada Stations as described in Golder (2013a)

Site ID ¹	Site Description	Watershed Area (km ²)	7Q ₂₀ (m ³ /s)	30Q ₂ (m ³ /s)	7Q ₂₀ Unit Flow (L/s/km ²)	Notes
02JC008	Blanche River above Eagleheart (Environment Canada Station)	1782	2.27	4.53	1.3	Used as reference station for pro-rating local gauge flow statistics
02CF012	Junction Creek at Sudbury (Environment Canada Station)	199	0.36	1.17	1.8	Urban station; regulated upstream of gauge not used in statistical estimates
04LA006	Mollie River at Highway No. 144 (Environment Canada Station)	92	0.12	0.24	1.3	Period of record 2007 - 2012 flow statistics based on 02JC008
NEV	Neville Lake	304	0.39	0.77	1.3	--
SR	Somme River @ Neville Lake	199	0.25	0.51	1.3	--
BL_b	Bagsverd Creek @ Neville Lake	82	0.10	0.21	1.3	--
L2	Un-named Lake 2	12	0.02	0.03	1.3	--
BPD	Bagsverd Lake	43	0.05	0.11	1.3	--
SL	Schist Lake	31	0.04	0.08	1.3	--
LCM	Little Clam Lake	0.3	0.00	0.00	n/a	zero flow observed during field campaign (Golder 2013a)
DIV	Dividing Lake	92	0.12	0.24	1.3	--
DEL	Delaney Lake	9	0.01	0.02	1.3	--
3D_c	Three Duck Lakes	57	0.07	0.14	1.3	--
WD	Weeduck Lake	1	0.00	0.00	1.3	--
CL	Côté Lake	43	0.05	0.11	1.3	--
CM	Clam Lake	4	0.00	0.01	1.3	--
CHLK	Chester Lake	33	0.04	0.09	1.3	--

¹ Site ID for non-Environment Canada Stations as described in Golder (2013a)

Precipitation Scenario	Month	Rainfall (mm)	Snowfall (cm)	Snow Melt (mm) ¹	Potential Evapotranspiration (mm)
Average Conditions (1:2-year Total Annual Precipitation)	January	0.0	72.6	0.0	0.0
	February	16.4	54.5	2.0	0.3
	March	9.8	52.1	4.4	0.1
	April	22.8	7.2	94.5	19.8
	May	76.6	0.0	131.2	59.3
	June	61.9	0.0	0.0	117.3
	July	85.5	0.0	0.0	119.9
	August	63.6	0.0	0.0	110.8
	September	95.2	0.0	0.0	82.5
	October	59.5	0.0	0.0	51.2
	November	41.8	32.8	10.8	4.0
	December	40.4	61.6	3.5	0.5
Wet Conditions (1:25-year Total Annual Precipitation)	January	0.0	83.2	0.0	0.0
	February	3.6	47.7	4.4	0.7
	March	28.2	14.7	55.9	9.7
	April	22.8	16.3	163.8	33.7
	May	109.8	0.0	20.4	63.5
	June	137.8	0.0	0.0	106.3
	July	116.6	0.0	0.0	130.9
	August	47.9	0.0	0.0	114.3
	September	84.6	0.0	0.0	62.8
	October	142.1	5.7	1.7	25.4
	November	31.3	51.3	17.8	7.5
	December	8.2	50.8	0.8	0.2
Dry Conditions (1:25-year Total Annual Precipitation)	January	0.0	50.0	0.9	0.0
	February	1.1	37.7	12.3	2.0
	March	10.5	27.3	32.7	5.7
	April	45.1	0.4	120.7	33.1
	May	35.4	0.0	0.0	74.3
	June	45.3	0.0	0.0	133.5
	July	51.7	0.0	0.0	140.5
	August	56.5	0.0	0.0	125.5
	September	94.5	0.0	0.0	84.5
	October	103.3	0.0	0.0	40.9
	November	80.9	50.5	24.4	5.9
	December	0.0	43.9	0.0	0.0

¹ Simulated snowmelt also incorporates snowpack from preceding year

Average Annual Discharge (m ³ /day), Existing Conditions				
Location	Watershed	Wet Conditions	Average Conditions	Dry Conditions
		1:25-year Total Annual P	1:2-year Total Annual P	1:25-year Total Annual P
Mesomikenda Lake Outflow	Mesomikenda	614,000	498,600	360,200
Neville Lake Outflow	Mesomikenda	293,500	234,400	160,400
Somme River Outflow	Mesomikenda	200,700	155,300	106,800
Bagsverd Creek downstream of Effluent Discharge ¹	Mesomikenda	86,800	69,500	50,600
Bagsverd Creek upstream of Effluent Discharge ¹	Mesomikenda	85,100	68,200	49,500
Un-named Lake 2 Outflow	Mesomikenda	12,000	10,000	7,000
Bagsverd Lake Outflow	Mesomikenda	42,100	34,000	22,700
Schist Lake Outflow	Mesomikenda	29,700	24,700	16,100
Little Clam Lake Outflow	Mesomikenda	300	200	200
Dividing Lake Outflow	Mollie River	103,200	79,700	61,400
Delaney Lake Outflow	Mollie River	9,700	7,500	5,800
Three Duck Lakes Outflow	Mollie River	64,400	50,100	38,300
Weeduck Lake Outflow	Mollie River	800	800	500
Côté Lake Outflow	Mollie River	49,500	39,000	30,600
Clam Lake Outflow	Mollie River	3,700	3,100	2,000
Chester Lake Outflow	Mollie River	40,100	31,500	25,200

¹ No treated effluent discharge to Bagsverd Creek under Existing Conditions; noted here for consistency with Operations Phase.

Average Annual Discharge (m ³ /day), Operations Phase with Treated Effluent Discharge to Bagsverd Creek				
Location	Watershed	Wet Conditions	Average Conditions	Dry Conditions
		1:25-year Total Annual P	1:2-year Total Annual P	1:25-year Total Annual P
Mesomikenda Lake Outflow	Mesomikenda	602,400	486,800	350,100
Neville Lake Outflow	Mesomikenda	281,900	223,000	149,200
Somme River Outflow	Mesomikenda	200,800	155,300	106,800
Bagsverd Creek downstream of Effluent Discharge	Mesomikenda	76,500	59,200	40,400
Bagsverd Creek upstream of Effluent Discharge	Mesomikenda	68,600	54,500	39,200
Un-named Lake 2 Outflow	Mesomikenda	52,400	42,000	28,800
Bagsverd Lake Outflow	Mesomikenda	36,400	29,500	19,100
Schist Lake Outflow	Mesomikenda	29,700	24,700	16,100
Little Clam Lake Outflow	Mollie River	43,300	34,000	27,200
Dividing Lake Outflow	Mollie River	100,000	76,800	59,900
Delaney Lake Outflow	Mollie River	9,600	7,500	5,800
Three Duck Lakes Outflow	Mollie River	62,600	48,300	37,600
Weeduck Lake Outflow	Mollie River	49,300	38,500	30,700
Côté Lake Outflow	Mollie River	n/a	n/a	n/a
Clam Lake Outflow	Mollie River	43,000	33,700	27,000
Chester Lake Outflow	Mollie River	39,100	30,800	24,700

Average Annual Discharge (m ³ /day), Operations Phase with Treated Effluent Discharge to Mesomikenda Lake				
Location	Watershed	Wet Conditions	Average Conditions	Dry Conditions
		1:25-year Total Annual P	1:2-year Total Annual P	1:25-year Total Annual P
Mesomikenda Lake Outflow	Mesomikenda	602,400	486,800	350,100
Neville Lake Outflow	Mesomikenda	275,700	219,600	149,200
Somme River Outflow	Mesomikenda	200,800	155,300	106,800
Bagsverd Creek downstream of Effluent Discharge ¹	Mesomikenda	70,400	55,800	40,400
Bagsverd Creek upstream of Effluent Discharge ¹	Mesomikenda	68,600	54,500	39,200
Un-named Lake 2 Outflow	Mesomikenda	52,400	42,000	28,800
Bagsverd Lake Outflow	Mesomikenda	36,400	29,500	19,100
Schist Lake Outflow	Mesomikenda	29,700	24,700	16,100
Little Clam Lake Outflow	Mollie River	43,300	34,000	27,200
Dividing Lake Outflow	Mollie River	100,000	76,800	59,900
Delaney Lake Outflow	Mollie River	9,600	7,500	5,800
Three Duck Lakes Outflow	Mollie River	62,600	48,300	37,600
Weeduck Lake Outflow	Mollie River	49,300	38,500	30,700
Côté Lake Outflow	Mollie River	n/a	n/a	n/a
Clam Lake Outflow	Mollie River	43,000	33,700	27,000
Chester Lake Outflow	Mollie River	39,100	30,800	24,700

¹ No treated effluent discharge to Bagsverd Creek during this scenario.

Average Annual Discharge (m ³ /day), Post-Closure Phase Stage I				
Location	Watershed	Wet Conditions	Average Conditions	Dry Conditions
		1:25-year Total Annual P	1:2-year Total Annual P	1:25-year Total Annual P
Mesomikenda Lake Outflow	Mesomikenda	608,000	492,400	357,200
Neville Lake Outflow	Mesomikenda	276,800	220,400	149,800
Somme River Outflow	Mesomikenda	200,800	155,300	106,800
Bagsverd Creek downstream of Effluent Discharge ¹	Mesomikenda	71,500	56,600	41,000
Bagsverd Creek upstream of Effluent Discharge ¹	Mesomikenda	69,700	55,300	39,800
Un-named Lake 2 Outflow	Mesomikenda	52,400	42,000	28,800
Bagsverd Lake Outflow	Mesomikenda	36,300	29,500	19,000
Schist Lake Outflow	Mesomikenda	29,700	24,700	16,100
Little Clam Lake Outflow	Mollie River	43,300	34,000	27,200
Dividing Lake Outflow	Mollie River	100,000	76,800	59,900
Delaney Lake Outflow	Mollie River	9,600	7,500	5,800
Three Duck Lakes Outflow	Mollie River	62,600	48,300	37,600
Weeduck Lake Outflow	Mollie River	49,300	38,500	30,700
Côté Lake Outflow	Mollie River	n/a	n/a	n/a
Clam Lake Outflow	Mollie River	43,000	33,700	27,000
Chester Lake Outflow	Mollie River	39,100	30,800	24,700

¹ No treated effluent discharge to Bagsverd Creek during this scenario.

Average Annual Discharge (m ³ /day), Post-Closure Phase Stage II				
Location	Watershed	Wet Conditions	Average Conditions	Dry Conditions
		1:25-year Total Annual P	1:2-year Total Annual P	1:25-year Total Annual P
Mesomikenda Lake Outflow	Mesomikenda	612,600	496,200	359,600
Neville Lake Outflow	Mesomikenda	281,900	224,300	152,700
Somme River Outflow	Mesomikenda	200,800	155,300	106,800
Bagsverd Creek downstream of Effluent Discharge ¹	Mesomikenda	75,100	59,400	43,000
Un-named Lake 2 Outflow	Mesomikenda	57,500	45,900	31,800
Bagsverd Lake Outflow	Mesomikenda	41,500	33,400	22,100
Schist Lake Outflow	Mesomikenda	29,700	24,700	16,100
Little Clam Lake Outflow	Mollie River	n/a ²	n/a	n/a
Dividing Lake Outflow	Mollie River	107,700	81,700	62,400
Delaney Lake Outflow	Mollie River	9,800	7,600	5,800
Three Duck Lakes Outflow	Mollie River	69,300	52,300	39,700
Weeduck Lake Outflow	Mollie River	1,200	900	600
Côté Lake Outflow	Mollie River	51,700	39,400	30,600
Clam Lake Outflow	Mollie River	45,100	35,300	28,100
Chester Lake Outflow	Mollie River	40,900	32,100	25,700

¹ No treated effluent discharge to Bagsverd Creek during this scenario.

² Little Clam Lake and Clam Lake merge in Post-Closure Phase Stage II, outflow from Clam Lake.

Average Annual Water Level (masl), Existing Conditions				
Location	Watershed	Wet Conditions	Average Conditions	Dry Conditions
		1:25-year Total Annual P	1:2-year Total Annual P	1:25-year Total Annual P
Mesomikenda Lake	Mesomikenda	364.1	364.0	363.5
Neville Lake	Mesomikenda	369.3	369.2	369.2
Somme River @ Neville Lake	Mesomikenda	372.0	371.9	371.9
Bagsverd Creek upstream of Effluent Discharge ¹	Mesomikenda	369.8	369.7	369.7
Un-named Lake 2 ²	Mesomikenda	371.3	372.0	370.4
Bagsverd Lake	Mesomikenda	380.0	380.0	380.0
Schist Lake	Mesomikenda	380.4	380.4	380.3
Little Clam Lake	Mesomikenda	387.6	387.5	387.4
Three Duck Lakes @ Outflow	Mollie River	380.4	380.3	379.9
Weeduck Lake	Mollie River	381.5	381.4	381.3
Côté Lake	Mollie River	380.2	380.2	380.1
Clam Lake	Mollie River	386.0	386.0	385.9
Chester Lake	Mollie River	384.8	384.7	384.7

¹ No treated effluent discharge to Bagsverd Creek under Existing Conditions; noted here for consistency with Operations Phase.

² For this location, observed conditions suggested that low water level was maintained at the culvert invert (approx. 373.2 masl). As a result of the modelling method (no routing and baseflow directed to the downstream watershed) the simulated water level is likely underestimated at this location.

Average Annual Water Level (masl), Operations Phase with Treated Effluent Discharge to Bagsverd Creek				
Location	Watershed	Wet Conditions	Average Conditions	Dry Conditions
		1:25-year Total Annual P	1:2-year Total Annual P	1:25-year Total Annual P
Mesomikenda Lake	Mesomikenda	364.1	364.0	363.5
Neville Lake	Mesomikenda	369.2	369.2	369.1
Somme River @ Neville Lake	Mesomikenda	372.0	371.9	371.9
Bagsverd Creek upstream of Effluent Discharge	Mesomikenda	369.7	369.7	369.6
Un-named Lake 2	Mesomikenda	373.6	373.5	373.2
Bagsverd Lake	Mesomikenda	380.6	380.6	380.6
Schist Lake	Mesomikenda	380.5	380.4	380.3
Little Clam Lake	Mollie River	385.1	385.1	385.1
Three Duck Lakes @ Outflow	Mollie River	380.5	380.4	380.2
Weeduck Lake	Mollie River	380.9	380.9	380.9
Côté Lake	Mollie River	n/a	n/a	n/a
Clam Lake	Mollie River	385.1	385.1	385.1
Chester Lake	Mollie River	386.2	386.2	386.2

Average Annual Water Level (masl), Operations Phase with Treated Effluent Discharge to Mesomikenda Lake				
Location	Watershed	Wet Conditions	Average Conditions	Dry Conditions
		1:25-year Total Annual P	1:2-year Total Annual P	1:25-year Total Annual P
Mesomikenda Lake	Mesomikenda	364.1	364.0	363.5
Neville Lake	Mesomikenda	369.2	369.2	369.1
Somme River @ Neville Lake	Mesomikenda	372.0	371.9	371.9
Bagsverd Creek upstream of Effluent Discharge ¹	Mesomikenda	369.8	369.7	369.6
Un-named Lake 2	Mesomikenda	373.6	373.5	373.2
Bagsverd Lake	Mesomikenda	380.6	380.6	380.6
Schist Lake	Mesomikenda	380.4	380.4	380.3
Little Clam Lake	Mollie River	385.1	385.1	385.1
Three Duck Lakes @ Outflow	Mollie River	380.4	380.4	380.2
Weeduck Lake	Mollie River	380.9	380.9	380.9
Côté Lake	Mollie River	n/a	n/a	n/a
Clam Lake	Mollie River	385.1	385.1	385.1
Chester Lake	Mollie River	386.3	386.2	386.2

¹ No treated effluent discharge to Bagsverd Creek for this scenario

Average Annual Water Level (masl), Post-Closure Phase Stage I				
Location	Watershed	Wet Conditions	Average Conditions	Dry Conditions
		1:25-year Total Annual P	1:2-year Total Annual P	1:25-year Total Annual P
Mesomikenda Lake	Mesomikenda	364.1	364.0	363.5
Neville Lake	Mesomikenda	369.2	369.2	369.1
Somme River @ Neville Lake	Mesomikenda	372.0	371.9	371.9
Bagsverd Creek upstream of Effluent Discharge ¹	Mesomikenda	369.8	369.7	369.6
Un-named Lake 2	Mesomikenda	373.6	373.5	373.2
Bagsverd Lake	Mesomikenda	380.6	380.6	380.6
Schist Lake	Mesomikenda	380.4	380.4	380.3
Little Clam Lake	Mollie River	385.1	385.1	385.1
Three Duck Lakes @ Outflow	Mollie River	380.4	380.4	380.2
Weeduck Lake	Mollie River	380.9	380.9	380.9
Côté Lake	Mollie River	n/a	n/a	n/a
Clam Lake	Mollie River	385.1	385.1	385.1
Chester Lake	Mollie River	386.3	386.2	386.2

¹ No treated effluent discharge to Bagsverd Creek for this scenario

Average Annual Water Level (masl), Post-Closure Phase Stage II				
Location	Watershed	Wet Conditions	Average Conditions	Dry Conditions
		1:25-year Total Annual P	1:2-year Total Annual P	1:25-year Total Annual P
Mesomikenda Lake	Mesomikenda	364.1	364.0	363.5
Neville Lake	Mesomikenda	369.2	369.2	369.1
Somme River @ Neville Lake	Mesomikenda	372.0	371.9	371.9
Bagsverd Creek upstream of Effluent Discharge ¹	Mesomikenda	369.8	369.7	369.6
Un-named Lake 2	Mesomikenda	373.6	373.5	373.1
Bagsverd Lake	Mesomikenda	380.6	380.6	380.6
Schist Lake	Mesomikenda	380.4	380.4	380.3
Little Clam Lake	Mollie River	384.8	384.6	384.3
Three Duck Lakes @ Outflow	Mollie River	380.5	380.4	380.3
Weeduck Lake	Mollie River	380.7	380.6	380.6
Côté Lake	Mollie River	380.2	380.2	380.1
Clam Lake	Mollie River	385.1	385.1	385.1
Chester Lake	Mollie River	386.3	386.2	386.2

¹ No treated effluent discharge to Bagsverd Creek for this scenario



APPENDIX B

Simulated Monthly Climate

Appendix B
Table B-1
Simulated Monthly Climate

Precipitation Scenario	Month	Rainfall (mm)	Snowfall (cm)	Snow Melt (mm) ¹	Potential Evapotranspiration (mm)
Average Conditions (1:2-year Total Annual Precipitation)	January	0.0	72.6	0.0	0.0
	February	16.4	54.5	2.0	0.3
	March	9.8	52.1	4.4	0.1
	April	22.8	7.2	94.5	19.8
	May	76.6	0.0	131.2	59.3
	June	61.9	0.0	0.0	117.3
	July	85.5	0.0	0.0	119.9
	August	63.6	0.0	0.0	110.8
	September	95.2	0.0	0.0	82.5
	October	59.5	0.0	0.0	51.2
	November	41.8	32.8	10.8	4.0
	December	40.4	61.6	3.5	0.5
Wet Conditions (1:25-year Total Annual Precipitation)	January	0.0	83.2	0.0	0.0
	February	3.6	47.7	4.4	0.7
	March	28.2	14.7	55.9	9.7
	April	22.8	16.3	163.8	33.7
	May	109.8	0.0	20.4	63.5
	June	137.8	0.0	0.0	106.3
	July	116.6	0.0	0.0	130.9
	August	47.9	0.0	0.0	114.3
	September	84.6	0.0	0.0	62.8
	October	142.1	5.7	1.7	25.4
	November	31.3	51.3	17.8	7.5
	December	8.2	50.8	0.8	0.2
Dry Conditions (1:25-year Total Annual Precipitation)	January	0.0	50.0	0.9	0.0
	February	1.1	37.7	12.3	2.0
	March	10.5	27.3	32.7	5.7
	April	45.1	0.4	120.7	33.1
	May	35.4	0.0	0.0	74.3
	June	45.3	0.0	0.0	133.5
	July	51.7	0.0	0.0	140.5
	August	56.5	0.0	0.0	125.5
	September	94.5	0.0	0.0	84.5
	October	103.3	0.0	0.0	40.9
	November	80.9	50.5	24.4	5.9
	December	0.0	43.9	0.0	0.0

¹ Simulated snowmelt also incorporates snowpack from preceding year



APPENDIX C

Hydrological Model Output

Average Annual Discharge (m ³ /day), Existing Conditions				
Location	Watershed	Wet Conditions	Average Conditions	Dry Conditions
		1:25-year Total Annual P	1:2-year Total Annual P	1:25-year Total Annual P
Mesomikenda Lake Outflow	Mesomikenda	614,000	498,600	360,200
Neville Lake Outflow	Mesomikenda	293,500	234,400	160,400
Somme River Outflow	Mesomikenda	200,700	155,300	106,800
Bagsverd Creek downstream of Effluent Discharge ¹	Mesomikenda	86,800	69,500	50,600
Bagsverd Creek upstream of Effluent Discharge ¹	Mesomikenda	85,100	68,200	49,500
Un-named Lake 2 Outflow	Mesomikenda	12,000	10,000	7,000
Bagsverd Lake Outflow	Mesomikenda	42,100	34,000	22,700
Schist Lake Outflow	Mesomikenda	29,700	24,700	16,100
Little Clam Lake Outflow	Mesomikenda	300	200	200
Dividing Lake Outflow	Mollie River	103,200	79,700	61,400
Delaney Lake Outflow	Mollie River	9,700	7,500	5,800
Three Duck Lakes Outflow	Mollie River	64,400	50,100	38,300
Weeduck Lake Outflow	Mollie River	800	800	500
Côté Lake Outflow	Mollie River	49,500	39,000	30,600
Clam Lake Outflow	Mollie River	3,700	3,100	2,000
Chester Lake Outflow	Mollie River	40,100	31,500	25,200

¹ No treated effluent discharge to Bagsverd Creek under Existing Conditions; noted here for consistency with Operations Phase.

Average Annual Discharge (m ³ /day), Operations Phase with Treated Effluent Discharge to Bagsverd Creek				
Location	Watershed	Wet Conditions	Average Conditions	Dry Conditions
		1:25-year Total Annual P	1:2-year Total Annual P	1:25-year Total Annual P
Mesomikenda Lake Outflow	Mesomikenda	602,400	486,800	350,100
Neville Lake Outflow	Mesomikenda	281,900	223,000	149,200
Somme River Outflow	Mesomikenda	200,800	155,300	106,800
Bagsverd Creek downstream of Effluent Discharge	Mesomikenda	76,500	59,200	40,400
Bagsverd Creek upstream of Effluent Discharge	Mesomikenda	68,600	54,500	39,200
Un-named Lake 2 Outflow	Mesomikenda	52,400	42,000	28,800
Bagsverd Lake Outflow	Mesomikenda	36,400	29,500	19,100
Schist Lake Outflow	Mesomikenda	29,700	24,700	16,100
Little Clam Lake Outflow	Mollie River	43,300	34,000	27,200
Dividing Lake Outflow	Mollie River	100,000	76,800	59,900
Delaney Lake Outflow	Mollie River	9,600	7,500	5,800
Three Duck Lakes Outflow	Mollie River	62,600	48,300	37,600
Weeduck Lake Outflow	Mollie River	49,300	38,500	30,700
Côté Lake Outflow	Mollie River	n/a	n/a	n/a
Clam Lake Outflow	Mollie River	43,000	33,700	27,000
Chester Lake Outflow	Mollie River	39,100	30,800	24,700

Average Annual Discharge (m ³ /day), Operations Phase with Treated Effluent Discharge to Mesomikenda Lake				
Location	Watershed	Wet Conditions	Average Conditions	Dry Conditions
		1:25-year Total Annual P	1:2-year Total Annual P	1:25-year Total Annual P
Mesomikenda Lake Outflow	Mesomikenda	602,400	486,800	350,100
Neville Lake Outflow	Mesomikenda	275,700	219,600	149,200
Somme River Outflow	Mesomikenda	200,800	155,300	106,800
Bagsverd Creek downstream of Effluent Discharge ¹	Mesomikenda	70,400	55,800	40,400
Bagsverd Creek upstream of Effluent Discharge ¹	Mesomikenda	68,600	54,500	39,200
Un-named Lake 2 Outflow	Mesomikenda	52,400	42,000	28,800
Bagsverd Lake Outflow	Mesomikenda	36,400	29,500	19,100
Schist Lake Outflow	Mesomikenda	29,700	24,700	16,100
Little Clam Lake Outflow	Mollie River	43,300	34,000	27,200
Dividing Lake Outflow	Mollie River	100,000	76,800	59,900
Delaney Lake Outflow	Mollie River	9,600	7,500	5,800
Three Duck Lakes Outflow	Mollie River	62,600	48,300	37,600
Weeduck Lake Outflow	Mollie River	49,300	38,500	30,700
Côté Lake Outflow	Mollie River	n/a	n/a	n/a
Clam Lake Outflow	Mollie River	43,000	33,700	27,000
Chester Lake Outflow	Mollie River	39,100	30,800	24,700

¹ No treated effluent discharge to Bagsverd Creek during this scenario.

Average Annual Discharge (m ³ /day), Post-Closure Phase Stage I				
Location	Watershed	Wet Conditions	Average Conditions	Dry Conditions
		1:25-year Total Annual P	1:2-year Total Annual P	1:25-year Total Annual P
Mesomikenda Lake Outflow	Mesomikenda	608,000	492,400	357,200
Neville Lake Outflow	Mesomikenda	276,800	220,400	149,800
Somme River Outflow	Mesomikenda	200,800	155,300	106,800
Bagsverd Creek downstream of Effluent Discharge ¹	Mesomikenda	71,500	56,600	41,000
Bagsverd Creek upstream of Effluent Discharge ¹	Mesomikenda	69,700	55,300	39,800
Un-named Lake 2 Outflow	Mesomikenda	52,400	42,000	28,800
Bagsverd Lake Outflow	Mesomikenda	36,300	29,500	19,000
Schist Lake Outflow	Mesomikenda	29,700	24,700	16,100
Little Clam Lake Outflow	Mollie River	43,300	34,000	27,200
Dividing Lake Outflow	Mollie River	100,000	76,800	59,900
Delaney Lake Outflow	Mollie River	9,600	7,500	5,800
Three Duck Lakes Outflow	Mollie River	62,600	48,300	37,600
Weeduck Lake Outflow	Mollie River	49,300	38,500	30,700
Côté Lake Outflow	Mollie River	n/a	n/a	n/a
Clam Lake Outflow	Mollie River	43,000	33,700	27,000
Chester Lake Outflow	Mollie River	39,100	30,800	24,700

¹ No treated effluent discharge to Bagsverd Creek during this scenario.

Average Annual Discharge (m ³ /day), Post-Closure Phase Stage II				
Location	Watershed	Wet Conditions	Average Conditions	Dry Conditions
		1:25-year Total Annual P	1:2-year Total Annual P	1:25-year Total Annual P
Mesomikenda Lake Outflow	Mesomikenda	612,600	496,200	359,600
Neville Lake Outflow	Mesomikenda	281,900	224,300	152,700
Somme River Outflow	Mesomikenda	200,800	155,300	106,800
Bagsverd Creek downstream of Effluent Discharge ¹	Mesomikenda	75,100	59,400	43,000
Un-named Lake 2 Outflow	Mesomikenda	57,500	45,900	31,800
Bagsverd Lake Outflow	Mesomikenda	41,500	33,400	22,100
Schist Lake Outflow	Mesomikenda	29,700	24,700	16,100
Little Clam Lake Outflow	Mollie River	n/a ²	n/a	n/a
Dividing Lake Outflow	Mollie River	107,700	81,700	62,400
Delaney Lake Outflow	Mollie River	9,800	7,600	5,800
Three Duck Lakes Outflow	Mollie River	69,300	52,300	39,700
Weeduck Lake Outflow	Mollie River	1,200	900	600
Côté Lake Outflow	Mollie River	51,700	39,400	30,600
Clam Lake Outflow	Mollie River	45,100	35,300	28,100
Chester Lake Outflow	Mollie River	40,900	32,100	25,700

¹ No treated effluent discharge to Bagsverd Creek during this scenario.

² Little Clam Lake and Clam Lake merge in Post-Closure Phase Stage II, outflow from Clam Lake.

Average Annual Water Level (masl), Existing Conditions				
Location	Watershed	Wet Conditions	Average Conditions	Dry Conditions
		1:25-year Total Annual P	1:2-year Total Annual P	1:25-year Total Annual P
Mesomikenda Lake	Mesomikenda	364.1	364.0	363.5
Neville Lake	Mesomikenda	369.3	369.2	369.2
Somme River @ Neville Lake	Mesomikenda	372.0	371.9	371.9
Bagsverd Creek upstream of Effluent Discharge ¹	Mesomikenda	369.8	369.7	369.7
Un-named Lake 2 ²	Mesomikenda	371.3	372.0	370.4
Bagsverd Lake	Mesomikenda	380.0	380.0	380.0
Schist Lake	Mesomikenda	380.4	380.4	380.3
Little Clam Lake	Mesomikenda	387.6	387.5	387.4
Three Duck Lakes @ Outflow	Mollie River	380.4	380.3	379.9
Weeduck Lake	Mollie River	381.5	381.4	381.3
Côté Lake	Mollie River	380.2	380.2	380.1
Clam Lake	Mollie River	386.0	386.0	385.9
Chester Lake	Mollie River	384.8	384.7	384.7

¹ No treated effluent discharge to Bagsverd Creek under Existing Conditions; noted here for consistency with Operations Phase.

² For this location, observed conditions suggested that low water level was maintained at the culvert invert (approx. 373.2 masl). As a result of the modelling method (no routing and baseflow directed to the downstream watershed) the simulated water level is likely underestimated at this location.

Average Annual Water Level (masl), Operations Phase with Treated Effluent Discharge to Bagsverd Creek				
Location	Watershed	Wet Conditions	Average Conditions	Dry Conditions
		1:25-year Total Annual P	1:2-year Total Annual P	1:25-year Total Annual P
Mesomikenda Lake	Mesomikenda	364.1	364.0	363.5
Neville Lake	Mesomikenda	369.2	369.2	369.1
Somme River @ Neville Lake	Mesomikenda	372.0	371.9	371.9
Bagsverd Creek upstream of Effluent Discharge	Mesomikenda	369.7	369.7	369.6
Un-named Lake 2	Mesomikenda	373.6	373.5	373.2
Bagsverd Lake	Mesomikenda	380.6	380.6	380.6
Schist Lake	Mesomikenda	380.5	380.4	380.3
Little Clam Lake	Mollie River	385.1	385.1	385.1
Three Duck Lakes @ Outflow	Mollie River	380.5	380.4	380.2
Weeduck Lake	Mollie River	380.9	380.9	380.9
Côté Lake	Mollie River	n/a	n/a	n/a
Clam Lake	Mollie River	385.1	385.1	385.1
Chester Lake	Mollie River	386.2	386.2	386.2

Average Annual Water Level (masl), Operations Phase with Treated Effluent Discharge to Mesomikenda Lake				
Location	Watershed	Wet Conditions	Average Conditions	Dry Conditions
		1:25-year Total Annual P	1:2-year Total Annual P	1:25-year Total Annual P
Mesomikenda Lake	Mesomikenda	364.1	364.0	363.5
Neville Lake	Mesomikenda	369.2	369.2	369.1
Somme River @ Neville Lake	Mesomikenda	372.0	371.9	371.9
Bagsverd Creek upstream of Effluent Discharge ¹	Mesomikenda	369.8	369.7	369.6
Un-named Lake 2	Mesomikenda	373.6	373.5	373.2
Bagsverd Lake	Mesomikenda	380.6	380.6	380.6
Schist Lake	Mesomikenda	380.4	380.4	380.3
Little Clam Lake	Mollie River	385.1	385.1	385.1
Three Duck Lakes @ Outflow	Mollie River	380.4	380.4	380.2
Weeduck Lake	Mollie River	380.9	380.9	380.9
Côté Lake	Mollie River	n/a	n/a	n/a
Clam Lake	Mollie River	385.1	385.1	385.1
Chester Lake	Mollie River	386.3	386.2	386.2

¹ No treated effluent discharge to Bagsverd Creek for this scenario

Average Annual Water Level (masl), Post-Closure Phase Stage I				
Location	Watershed	Wet Conditions	Average Conditions	Dry Conditions
		1:25-year Total Annual P	1:2-year Total Annual P	1:25-year Total Annual P
Mesomikenda Lake	Mesomikenda	364.1	364.0	363.5
Neville Lake	Mesomikenda	369.2	369.2	369.1
Somme River @ Neville Lake	Mesomikenda	372.0	371.9	371.9
Bagsverd Creek upstream of Effluent Discharge ¹	Mesomikenda	369.8	369.7	369.6
Un-named Lake 2	Mesomikenda	373.6	373.5	373.2
Bagsverd Lake	Mesomikenda	380.6	380.6	380.6
Schist Lake	Mesomikenda	380.4	380.4	380.3
Little Clam Lake	Mollie River	385.1	385.1	385.1
Three Duck Lakes @ Outflow	Mollie River	380.4	380.4	380.2
Weeduck Lake	Mollie River	380.9	380.9	380.9
Côté Lake	Mollie River	n/a	n/a	n/a
Clam Lake	Mollie River	385.1	385.1	385.1
Chester Lake	Mollie River	386.3	386.2	386.2

¹ No treated effluent discharge to Bagsverd Creek for this scenario

Average Annual Water Level (masl), Post-Closure Phase Stage II				
Location	Watershed	Wet Conditions	Average Conditions	Dry Conditions
		1:25-year Total Annual P	1:2-year Total Annual P	1:25-year Total Annual P
Mesomikenda Lake	Mesomikenda	364.1	364.0	363.5
Neville Lake	Mesomikenda	369.2	369.2	369.1
Somme River @ Neville Lake	Mesomikenda	372.0	371.9	371.9
Bagsverd Creek upstream of Effluent Discharge ¹	Mesomikenda	369.8	369.7	369.6
Un-named Lake 2	Mesomikenda	373.6	373.5	373.1
Bagsverd Lake	Mesomikenda	380.6	380.6	380.6
Schist Lake	Mesomikenda	380.4	380.4	380.3
Little Clam Lake	Mollie River	384.8	384.6	384.3
Three Duck Lakes @ Outflow	Mollie River	380.5	380.4	380.3
Weeduck Lake	Mollie River	380.7	380.6	380.6
Côté Lake	Mollie River	380.2	380.2	380.1
Clam Lake	Mollie River	385.1	385.1	385.1
Chester Lake	Mollie River	386.3	386.2	386.2

¹ No treated effluent discharge to Bagsverd Creek for this scenario

As a global, employee-owned organisation with over 50 years of experience, Golder Associates is driven by our purpose to engineer earth's development while preserving earth's integrity. We deliver solutions that help our clients achieve their sustainable development goals by providing a wide range of independent consulting, design and construction services in our specialist areas of earth, environment and energy.

For more information, visit golder.com

Africa	+ 27 11 254 4800
Asia	+ 86 21 6258 5522
Australasia	+ 61 3 8862 3500
Europe	+ 356 21 42 30 20
North America	+ 1 800 275 3281
South America	+ 56 2 2616 2000

solutions@golder.com
www.golder.com

Golder Associates Ltd.
1010 Lorne Street
Sudbury, Ontario, P3C 4R9
Canada
T: +1 (705) 524 6861



